

Supplementum I

MAPS

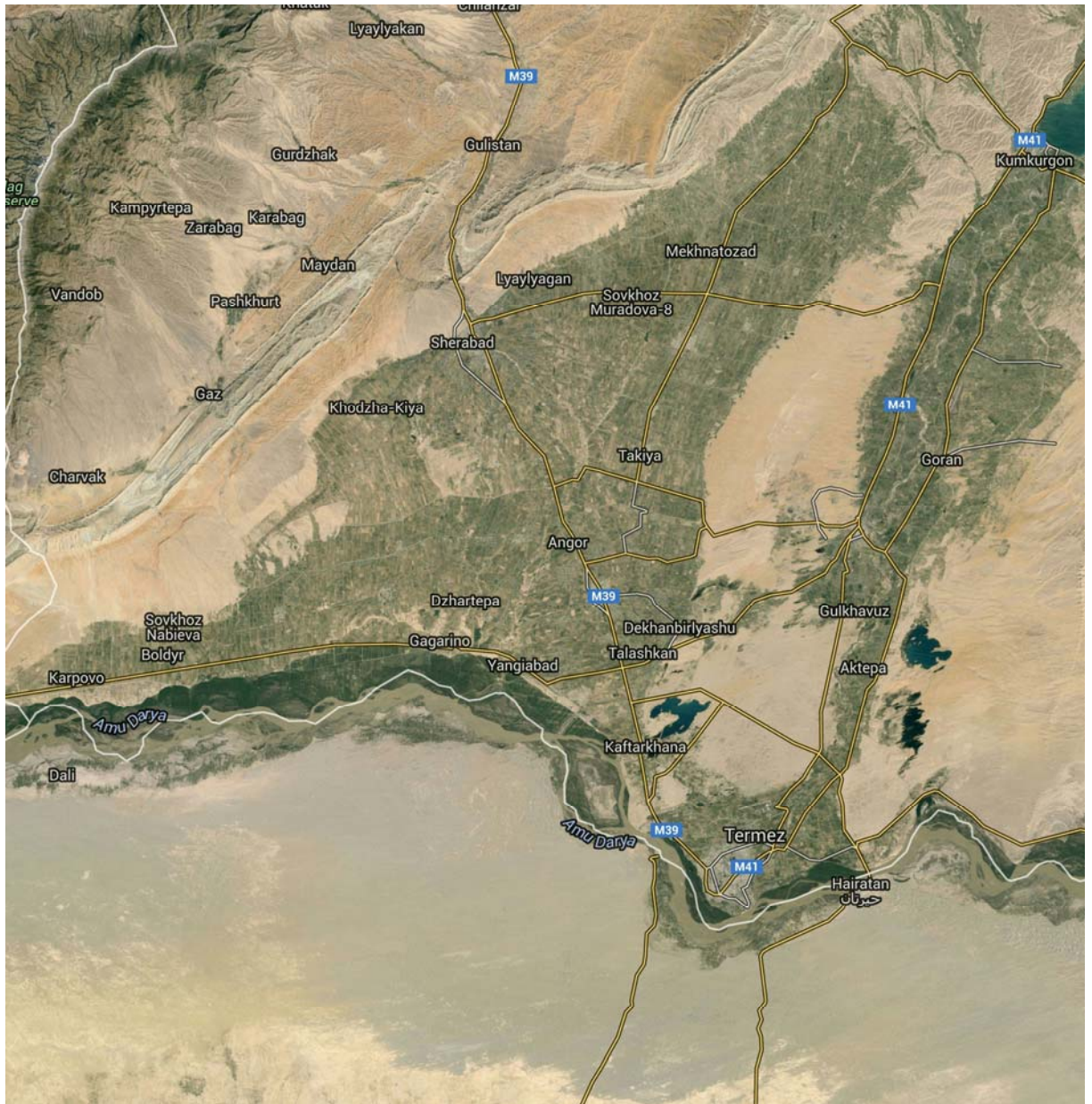

Map 1: Physical map of the Sherobod oasis and the upper Amu Darya valley region (source: Google Maps, www.google.cz/maps)



Map 2: Satellite image of the Sherobod oasis and the upper Amu Darya valley region (source: Google Maps, www.google.cz/maps)

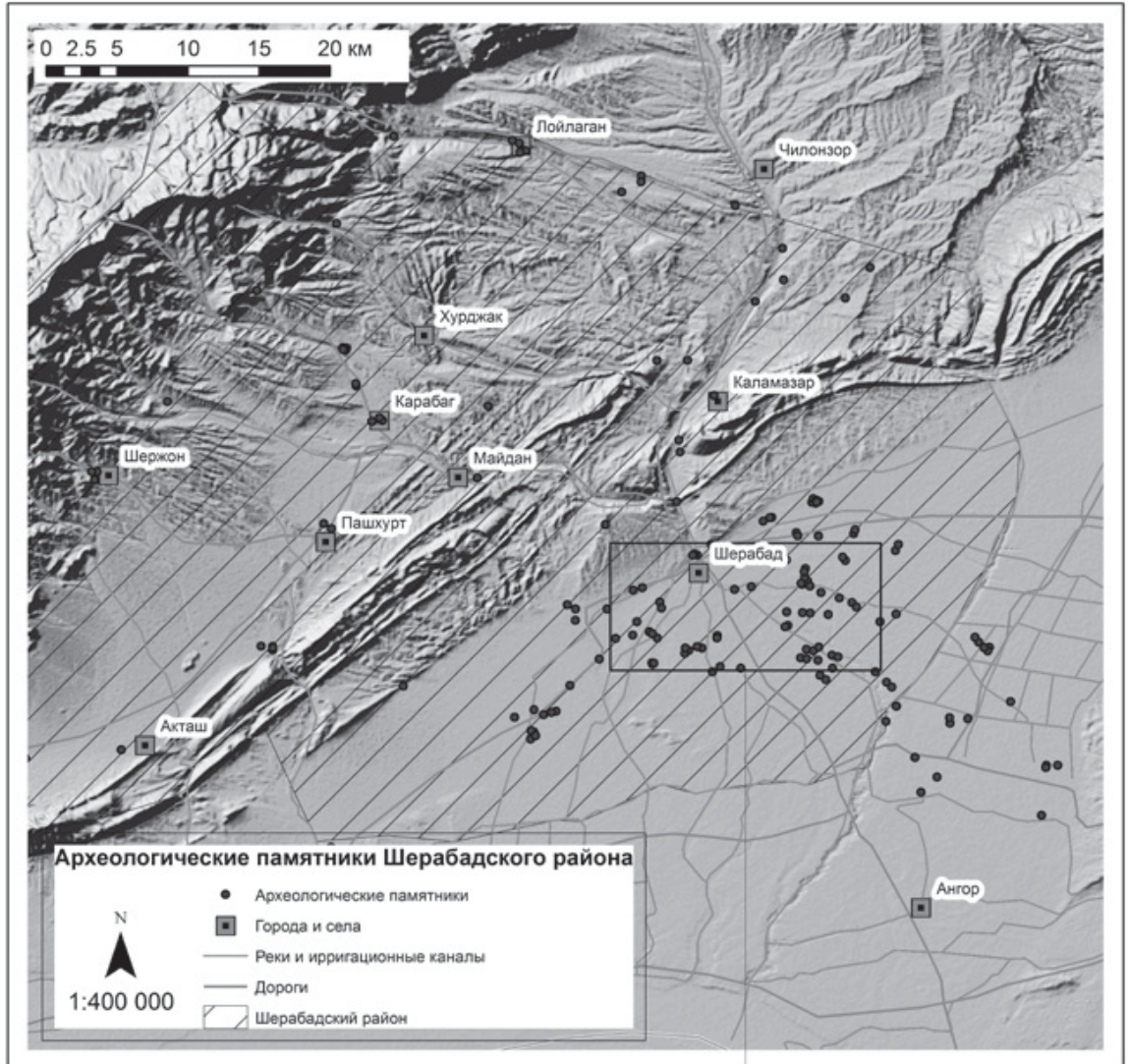

Map 3. Map and detailed satellite image of the Sherobod oasis with archaeological sites' occurrences recognised (source: STANČO *et al.* 2013, pp. 61)

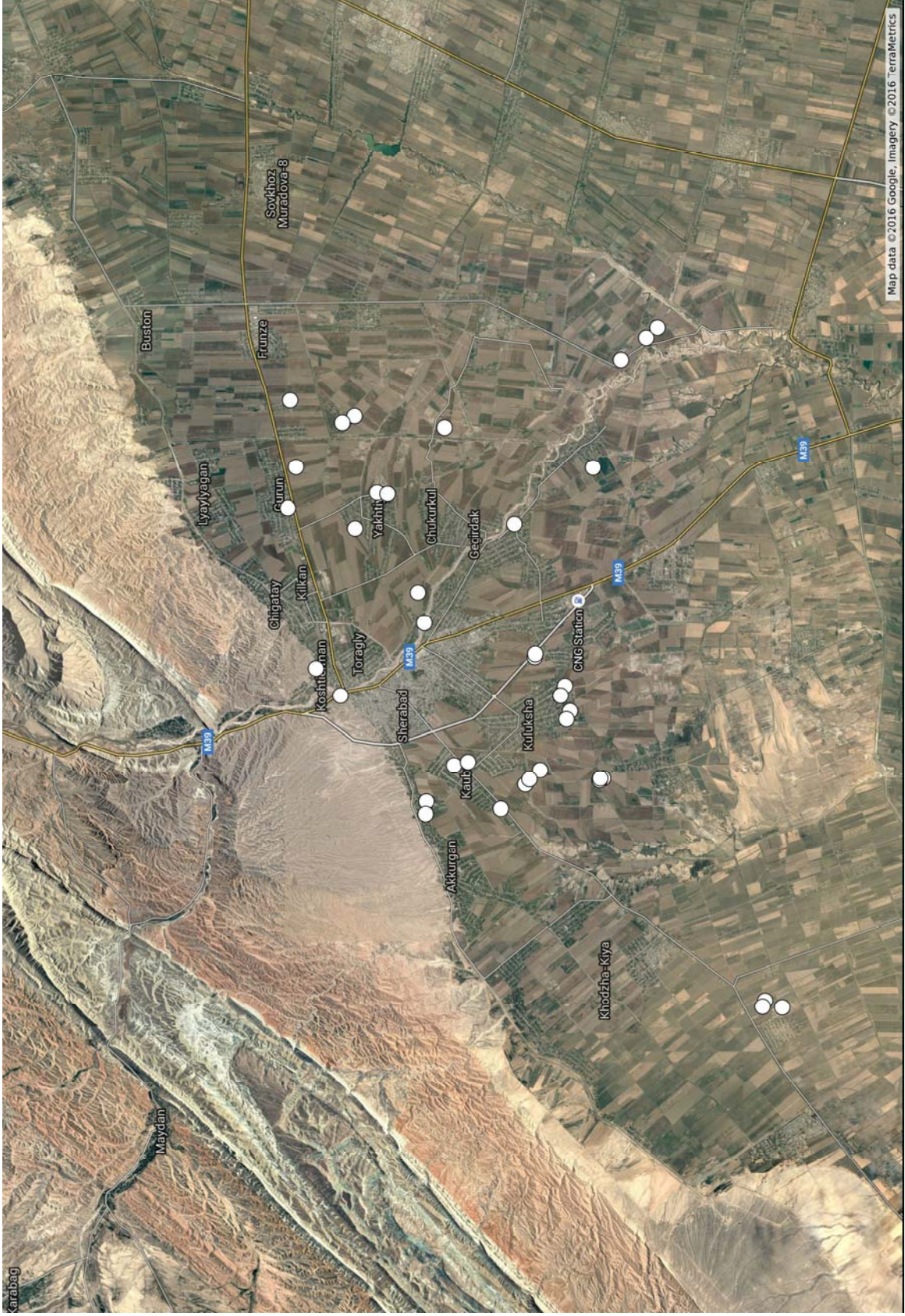

Map 4: Preliminary online map of surveyed sites (2009-2010) in Sherobod oasis (source: Google Maps, www.google.cz/maps)

Supplementum II

LIST
OF TABLES

Item #	Site #	Table #
1	1	I
2	1	I
3	1	I
4	1	I
5	2	I
6	2	I
7*	2	I
8	2	I
9	2	I
10	2	I
11	2	I
12	2	I
13	2	II
14	2	II
15	2	II
16	2	II
17	2	II
18	2	II
19	2	II
20	2	II
21	2	II
22	2	III
23	2	III
24	2	III
25	2	III
26	2	III
27	2	III
28	2	III
29	2	III
30	2	III
31	2	III
32*	2	III
33	2	III
34	2	I
35	2	I
36	2	I
37	2	I
38	2	III
39	3	III
40	3	III
41	3	III
42	3	III
43	3	III
44	3	III
45	4	III
46*	4	III
47	4	III
48	4	III
49	4	III
50	4	III
51	4	III
52	4	III
53	4	III
54	4	III
55	4	IV
56	4	IV
57	4	IV
58	4	IV
59	4	IV
60	4	IV
61	4	IV
62	4	IV
63*	4	IV

Item #	Site #	Table #
64	4	IV
65	4	IV
66*	4	IV
67*	5	IV
68	5	IV
69	5	IV
70	5	IV
71	5	IV
72	5	V
73	5	V
74	5	V
75	5	V
76	5	V
77	5	V
78	5	V
79	5	V
80	5	V
81	5	V
82	5	V
83	5	V
84	5	V
85	5	V
86	5	V
87	5	V
88	5	V
89	5	V
90	5	V
91	5	VI
92	5	VI
93	5	VI
94	5	VI
95	5	VI
96	5	VI
97	5	VI
98	5	VI
99*	5	VI
100*	5	VI
101	5	VI
102	5	VI
103	5	VI
104	5	VI
105	5	VI
106	5	VI
107	5	VI
108	5	VI
109	5	VI
110	5	VI
111*	5	VI
112	5	VI
113*	5	VI
114*	5	VII
115*	5	VII
116*	5	VII
117*	5	VII
118	5	VII
119	5	VII
120	5	VII
121	5	VII
122	5	VII
123	5	VII
124*	5	VII
125*	6	VII
126	6	VII

Item #	Site #	Table #
127	6	VII
128*	6	VII
129	6	VII
130*	6	VII
131	6	VII
132	6	VII
133	6	VII
134*	7	VII
135	7	VIII
136	7	VIII
137	7	VIII
138	7	VIII
139*	8	VIII
140	8	VIII
141*	8	VIII
142*	8	VIII
143	8	VIII
144	8	VIII
145	8	VIII
146	8	VIII
147	8	VIII
148	8	IX
149	8	IX
150	8	IX
151	8	IX
152	8	IX
153*	8	IX
154	8	IX
155	8	IX
156	8	IX
157*	9	IX
158*	10	IX
159	10	IX
160	10	IX
161	10	IX
162	10	IX
163	10	IX
164	10	IX
165	10	IX
166	10	IX
167	10	IX
168	10	IX
169	10	IX
170	10	IX
171	10	IX
172*	10	IX
173	10	X
174	10	X
175	10	X
176	10	X
177	10	X
178	10	X
179	10	X
180	10	X
181*	10	X
182	10	X
183*	10	X
184	10	X
185	10	X
186	11	XI
187	11	XI
188	11	XI
189	11	XI

Item #	Site #	Table #
190*	11	XI
191*	11	XI
192	11	XI
193	12	XI
194	12	XI
195	12	XI
196	12	XI
197	12	XI
198	12	XI
199	12	XI
200	12	XI
201	12	XI
202	12	XI
203	12	XI
204	12	XI
205	12	XI
206	12	XI
207	12	XI
208	12	XI
209	16	XI
210	16	XI
211	16	XII
212	16	XII
213*	16	XII
214	16	XII
215	16	XII
216	16	XII
217	16	XII
218	16	XII
219	16	XII
220	16	XII
221	16	XII
222*	16	XII
223	16	XII
224*	16	XII
225	16	XII
226	16	XII
227	16	XII
228	16	XII
229	16	XII
230	16	XII
231	16	XII
232	16	XIII
233	16	XII
234	16	XII
235	16	XII
236	16	XII
237	16	XII
238*	16	XIII
239*	16	XIII
240	16	XII
241	16	XII
242	16	XII
243	16	XII
244	16	XII
245	16	XII
246	16	XII
247	16	XII
248	16	XIII
249	16	XIII
250	16	XIII
251	16	XIII
252	16	XIII

Item #	Site #	Table #
253	16	XIII
254	16	XIII
255	16	XIII
256	16	XIII
257	16	XIII
258	17	XIII
259	17	XIII
260	17	XIII
261	17	XIII
262	17	XIII
263	17	XIII
264	17	XIII
265	17	XIV
266	17	XIV
267	17	XIV
268*	17	XIV
269	18	XIV
270	18	XIV
271	18	XIV
272	18	XIV
273*	18	XIV
274	18	XIV
275	18	XIV
276	18	XIV
277	18	XV
278	18	XV
279	18	XV
280	18	XV
281	18	XV
282	18	XV
283	18	XV
284	18	XV
285	18	XV
286	18	XV
287*	18	XV
288*	18	XV
289	18	XIV
290	18	XIV
291	18	XV
292	18	XV
293	19	XVI
294	19	XVI
295	19	XVI
296	19	XVI
297	19	XVI
298	19	XVI
299	19	XVI
300*	19	XVI
301	22	XVI
302	22	XVI
303*	22	XVI
304	22	XV
305*	22	XVI
306	22	XV
307	22	XVI
308	22	XVI
309*	22	XV
310	22	XVI
311	23	XVII
312	23	XVII
313*	23	XVII
314	23	XVII
315*	23	XVII

Item #	Site #	Table #
316	23	XVII
317	23	XVII
318	23	XVII
319*	23	XVII
320*	23	XVII
321*	23	XVII
322*	23	XVII
323	23	XVII
324	23	XVII
325	23	XVII
326	23	XVII
327	23	XVII
328	23	XVII
329	24	XVIII
330	24	XVIII
331	24	XVIII
332	24	XVIII
333	24	XVIII
334*	24	XVIII
335	24	XVIII
336	24	XIX
337	24	XIX
338*	24	XIX
339	24	XIX
340	24	XIX
341	24	XIX
342	24	XIX
343	24	XIX
344	24	XIX
345	24	XIX
346	24	XIX
347	24	XIX
348*	24	XIX
349*	24	XX
350*	24	XX
351	24	XX
352	24	XX
353	24	XX
354	24	XX
355*	24	XX
356	24	XX
357	24	XX
358	24	XX
359	25	XX
360	25	XX
361	25	XX
362	25	XX
363	25	XX
364	25	XX
365*	25	XX
366*	25	XX
367	25	XX
368	25	XX
369	25	XX
370*	25	XX
371	25	XXI
372	25	XXI
373	25	XXI
374	25	XXI
375	25	XXI
376	25	XXI
377	25	XXI
378	25	XXI
379	25	XXII

Item #	Site #	Table #
380	25	XX
381	25	XX
382	25	XX
383	25	XX
384	25	XX
385	25	XX
386	26	XXII
387	26	XXII
388	26	XXII
389	26	XXII
390	26	XXII
391	26	XXII
392	26	XXII
393	26	XXII
394	26	XXII
395	26	XXII
396	26	XXII
397	26	XXII
398	26	XXIII
399	26	XXIII
400*	26	XXIII
401	26	XXIII
402	26	XXIV
403	26	XXIII
404	26	XXIII
405	26	XXIII
406	26	XXIII
407	26	XXIII
408	26	XXIII
409	26	XXIV
410	26	XXIII
411	26	XXIII
412	26	XXIII
413	26	XXIII
414	26	XXIII
415	26	XXIII
416	26	XXIV
417	26	XXIV
418	26	XXIV
419	26	XXIV
420	26	XXIV
421	26	XXIV
422	26	XXIV
423	26	XXIV
424	26	XXIV
425*	26	XXIV
426	26	XXIV
427	26	XXIV
428	26	XXIV
429	26	XXIV
430	26	XXIV
431	26	XXIV
432*	26	XXIV
433	26	XXIV
434	26	XXIV
435	27	XXIV
436	27	XXIV
437	27	XXV
438*	27	XXV
439*	27	XXV
440*	27	XXV
441	27	XXV
442	27	XXV
443*	27	XXIV

Item #	Site #	Table #
444	27	XXV
445	32	XXV
446	32	XXV
447*	32	XXV
448	32	XXVI
449	32	XXVI
450	32	XXVI
451	32	XXVI
452	32	XXVI
453*	32	XXVI
454	32	XXVI
455	32	XXVI
456	32	XXVII
457*	32	XXVII
458	32	XXVII
459*	32	XXVII
460*	32	XXVII
461	32	XXVII
462	32	XXVIII
463	32	XXVIII
464	32	XXVIII
465	32	XXVIII
466	32	XXVIII
467	32	XXVIII
468*	32	XXVIII
469*	32	XXVIII
470*	32	XXX
471	32	XXX
472*	32	XXX
473*	32	XXVII
474	32	XXVIII
475	32	XXVII
476*	32	XXVII
477	32	XXVII
478	32	XXVII
479*	33	XXIX
480*	33	XXIX
481	33	XXX
482	33	XXX
483	33	XXX
484	33	XXX
485*	33	XXX
486	33	XXX
487	33	XXX
488*	33	XXX
489	33	XXXI
490	33	XXXI
491	33	XXXI
492*	33	XXXI
493	33	XXXI
494*	33	XXXI
495*	33	XXXI
496*	33	XXXI
497	33	XXX
498*	33	XXXII
499	33	XXXII
500*	33	XXXII
501*	33	XXXII
502*	33	XXXII
503*	33	XXXII
504	35	XXXII
505	35	XXXII
506	35	XXXII
507*	35	XXXII

Item #	Site #	Table #
508	35	XXXII
509	35	XXXIII
510*	35/36/23	XXXII
511*	36	XXXII
512	36	XXXII
513	36	XXXII
514	37	XXXIII
515	37	XXXIII
516	37	XXXIII
517	37	XXXIII
518	37	XXXIII
519	37	XXXIII
520	37	XXXIII
521	37	XXXIII
522	37	XXXIII
523	37	XXXIII
524	37	XXXIII
525	37	XXXIV
526	37	XXXIV
527	37	XXXIV
528	37	XXXIV
529	37	XXXIV
530	38	XXXIV
531	40	XXXIV
532	40	XXXIV
533	40	XXXIV
534	40	XXXIV
535	40	XXXIV
536	40	XXXIV
537	40	XXXIV
538	40	XXXIV
539	40	XXXIV
540	40	XXXIV
541	40	XXXIV
542	40	XXXIV
543	40	XXXIV
544	40	XXXIV
545*	40	XXXV
546	40	XXXIV
547	40	XXXIV
548	40	XXXIV
549	40	XXXIV
550	40	XXXIV
551	40	XXXIV
552	40	XXXIV
553	40	XXXIV
554	40	XXXIV
555	40	XXXIV
556	40	XXXIV
557	41	XXXV
558*	41	XXXV
559*	41	XXXV
560	41	XXXV
561	41	XXXV
562	42	XXXV
563	42	XXXV
564	42	XXXV
565	42	XXXV
566	42	XXXV
567	42	XXXV
568	42	XXXV
569	42	XXXV
570	42	XXXV
571	42	XXXV

Item #	Site #	Table #
572	42	XXXV
573	43	XXXVI
574	43	XXXVI
575	43	XXXVI
576	43	XXXVI
577	43	XXXVI
578	43	XXXVI
579	43	XXXVI
580	43	XXXVI
581	43	XXXVI
582	43	XXXVI
583	43	XXXVI
584	43	XXXVI
585	43	XXXVI
586	43	XXXVI
587*	43	XXXVI
588	45	XXXVI
589	45	XXXVI
590	45	XXXVI
591	45	XXXVI
592	45	XXXVI
593	45	XXXVI
594	45	XXXVII
595	45	XXXVII
596	45	XXXVII
597	45	XXXVII
598	45	XXXVII
599	45	XXXVII
600	45	XXXVII
601*	48	XXXVII
602	48	XXXVII
603	48	XXXVII
604*	48	XXXVII
605	48	XXXVII
606	48	XXXVII
607*	48	XXXVII
608*	49	XXXVIII
609	50	XXXVIII
610*	50	XXXVIII
611*	50	XXXVIII
612	50	XXXVIII
613	52	XXXVIII
614	52	XXXVIII
615	52	XXXVIII
616	52	XXXVIII
617	53	XXXVIII
618	53	XXXVIII
619*	54	XXXVIII
620	54	XXXVIII
621	54	XXXVIII
622	55	XXXVIII
623*	55	XXXVIII
624	55	XXXVIII
625	55	XXXVIII
626	55	XXXVIII
627*	55	XXXVIII
628	55	XXXVIII
629	55	XXXVIII
630	55	XXXVIII
631*	56	XXXVIII
632	56	XXXVIII
633	56	XXXVIII
634	56	XXXVIII
635	56	XXXIX

Item #	Site #	Table #
636	56	XXXIX
637	56	XXXVIII
638	56	XXXVIII
639	56	XXXVIII
640	56	XXXVIII
641	56	XXXIX
642	56	XXXIX
643	56	XXXIX
644	57	XXXIX
645*	57	XXXIX
646*	57	XXXIX
647	57	XXXIX
648	57	XXXIX
649	57	XXXIX
650	57	XXXIX
651	58	XXXIX
652	58	XXXIX
653	58	XXXIX
654	58	XXXIX
655	58	XXXIX
656	58	XXXIX
657	58	XXXIX
658	61	XL
659*	61	XL
660	61	XL
661*	61	XL
662*	62	XL
663	62	XL
664	63	XL
665	63	XL
666	63	XL
667	63	XL
668	63	XL
669	63	XL
670	63	XL
671*	63	XL
672	63	XL
673	63	XL
674	71	XL
675	72	XL
676	72	XL
677	72	XL
678	72	XLI
679*	72	XLI
680*	72	XL
681*	72	XLI
682*	72	XL
683	75	XLI
684	75	XLI
685	75	XLI
686	75	XLI
687*	75	XLI
688	75	XLI
689	75	XLI
690	77	XLI
691	77	XLI
692	77	XLI
693	77	XLI
694	78	XLI
695	78	XLI
696	78	XLI
697	78	XLI
698	78	XLII
699	78	XLII

Item #	Site #	Table #
700*	79	XLII
701	79	XLII
702*	79	XLII
703	79	XLII
704	79	XLII
705	79	XLII
706*	80	XLII
707	80	XLII
708	80	XLII
709	80	XLII
710	80	XLII
711	80	XLII
712	80	XLIII
713	80	XLIII
714	80	XLIII
715	80	XLIII
716	80	XLIII
717	80	XLIII
718	80	XLIII
719	80	XLIII
720	80	XLIII
721	80	XLIII
722	80	XLIII
723*	80	XLIII
724	80	XLIII
725*	80	XLII
726	80	XLIII
727	80	XLIII
728	80	XLIII
729	88	XLIV
730*	88	XLIII
731*	88	XLIII
732*	88	XLIII
733*	88	XLIII
734	88	XLIII
735	88	XLIII
736*	88	XLIII
737	88	XLIII
738*	88	XLIII
739*	90	XLIV
740	90	XLIV
741	90	XLIV
742	90	XLIV
743	90	XLIV
744	90	XLV
745	94	XLIV
746*	94	XLIV
747	94	XLIV
748*	94	XLIV
749	94	XLIV
750	94	XLIV
751	94	XLIV
752*	94	XLIV
753*	94	XLV
754	94	XLV
755	94	XLV
756	94	XLV
757	94	XLV
758	94	XLIV
759	94	XLIV
760	94	XLV
761*	94	XLIV
762	94	XLV
763	94	XLV

Item #	Site #	Table #
764	94	XLV
765*	94	XLV
766	95	XLVI
767	95	XLV
768	95	XLV
769	95	XLV
770	95	XLV
771	95	XLV
772	95	XLV
773	95	XLV
774	95	XLV
775	95	XLV
776	95	XLV
777*	95	XLV
778	95	XLV
779*	95	XLVI
780	95	XLVI
781*	95	XLVI
782	95	XLVI
783	95	XLVI
784	95	XLVII
785	95	XLVII
786	95	XLVII
787	95	XLVII
788*	95	XLVII
789	95	XLVII
790	96	XLVI
791	96	XLVI
792	98	XLVIII
793	98	XLVIII
794	98	XLIX
795	98	XLIX
796*	98	XLIX
797	98	XLIX
798*	98	XLIX
799*	98	XLIX
800*	98	XLIX
801*	98	XLIX
802*	98	XLIX
803	98	XLIX
804	98	XLIX
805*	98	XLIX
806	98	XLIX
807	98	XLIX
808	99	L
809	99	L
810*	99	L
811	99	L
812	99	LI
813	99	LI
814*	99	LI
815	99	LI
816	99	LI
817*	99	LI
818	99	LI
819	99	LI
820	99	LI
821*	99	L
822*	99	L
823*	99	LI
824	99	LI
825	99	LI
826	99	LI
827	100	LII

Item #	Site #	Table #
828	100	LII
829	100	LII
830*	100	LII
831	100	LII
832	100	LII
833	100	LIII
834	100	LIII
835	100	LIII
836	100	LIII
837*	100	LII
838	100	LIII
839*	100	LIII
840	100	LIII
841	100	LIII
842	101	LIV
843	101	LIV
844	101	LIV
845	101	LIV
846	101	LIV
847	101	LIV
848	101	LIV
849	101	LIV
850*	103	LIV
851*	103	LIV
852	103	LIV
853	103	LIV
854*	103	LIV
855	103	LIV
856	103	LVI
857	105	LV
858	105	LV
859	105	LV
860	105	LV
861	107	LVI
862	107	LV
863	107	LV
864	107	LV
865	107	LV
866	107	LV
867	108	LV
868	109	LVI
869	109	LVI
870	109	LV
871	109	LV
872	109	LV
873	109	LV
874	109	LV
875	109	LV
876	109	LV
877	109	LV
878	109	LV
879	109	LV
880	109	LV
881	110	LV
882	110	LV
883	110	LV
884*	110	LVI
885	112	LVII
886	112	LVII
887	112	LVII
888	112	LVII
889	112	LVII
890	112	LVII
891	113	LVII

Item #	Site #	Table #
892	113	LVII
893	113	LVII
894*	116	LVI
895	116	LVII
896*	117	LVI
897*	117	LVI
898	119	LVII
899	119	LVII
900	119	LVII
901	119	LVII
902	120	LVII
903	120	LVII
904	120	LVII
905	120	LVII
906*	120	LVII
907*	120	LVII
908*	120	LVII
909*	124	LVIII
910	124	LVIII
911	125	LVIII
912	125	LVIII
913	125	LVIII
914	125	LVIII
915	125	LVIII
916	125	LVIII
917	125	LIX
918	125	LVIII
919	125	LVIII
920	125	LVIII
921	127	LVIII
922*	127	LVIII
923*	128	LVIII
924	128	LVIII
925	128	LVIII
926*	128	LVIII
927*	128	LVIII
928*	129	LIX
929	129	LIX
930	129	LVIII
931	129	LVIII
932	131	LX
933	131	LX
934*	131	LX
935	131	LX
936	131	LX
937	133	LX
938	133	LX
939*	133	LX
940	133	LX
941	133	LX
942	133	LX
943	133	LXI
944	133	LXI
945	134	LXI
946	134	LXI
947*	134	LXI
948*	134	LXI
949	134	LXI
950	134	LXI
951*	135	LXI
952	135	LXI
953	136	LXI
954	136/137	LXI
955	138	LXI

Item #	Site #	Table #
956	139	LXI
957	141	LXI
958	141	LXI
959	142	LXI
960	142	LXI
961*	142	LXI
962	142	LXI
963	143	LXII
964	143	LXII
965	143	LXII
966	143	LXII
967	143	LXII
968	143	LXI
969*	143	LXI
970	143	LXI
971	144	LXII
972	145	LXII
973	145	LXII
974	145	LXII
975	145	LXII
976	145	LXII
977*	145	LXII
978	145	LXII
979*	145	LXII
980*	145	LXII
981*	145	LXII
982*	145	LXII
983	145	LXII
984	146	LXII
985	146	LXIII
986*	146	LXIII
987	146	LXIII
988	146	LXIII
989	149	LXIII
990	149	LXIII
991*	157	LXIII
992	157	LXIII
993	161	LXIII
994*	161	LXIII
995*	161	LXIII
996*	161	LXIII
997*	161	LXIV
998*	161	LXIV
999	161	LXIV
1000*	161	LXIV
1001	161	LXIV
1002	161	LXIV
1003	161	LXIV
1004	163	LXIV
1005	163	LXIV
1006	163	LXIV
1007*	165	LXIV
1008*	4	LXV
1009*	5	LXV
1010	96	LXV
1011*	26	LXV
1012	40	LXV
1013*	72	LXV
1014	33	LXV
1015*	60	LXV
1016*	48	LXV
1017*	32	LXV
1018*	32	LXV
1019*	99	LXV

Item #	Site #	Table #
1020*	48	LXV
1021*	61	LXV
1022*	98	LXV
1023*	5	LXV
1024*	80	LXV
1025	11	LXV

Supplementum III

CATALOGUE

LIST OF CATALOGUE ABBREVIATIONS

(a) Measurements

bd	base diameter	max	maximum	th	thickness
d	diameter	pht	preserved height	w	width
est	estimated				
ext	extant	pth	preserved		
ht	height		thickness		
l	length	rd	rim diameter		

(b) Descriptive (Form)

comp	complete	hdl	handle	pt	part(s)
ext	extant	hdlld	handled	sec	section
fr	fragment	horiz	horizontal	spt	spout
frag	fragmentary	incmp	incomplete	vert	vertical
frf	fragments	p	preserved	vsl	vessel

(c) Descriptive (Fabric)

CR	compression ridges	RS	red slip(ped)	unbrn	unburnished
		smt	smooth	WM	wheel made
HM	hand made	sl	slip	WR	wheel-ridges
in	inner	surf	surface(s)		
out	outer	TC	terracotta		

(d) Descriptive (Decoration)

burn	burnished	inc	incised	rsd	residue(s)
crvl	curvilinear	lin	linear	rsvd	reserved
dec	decorated / decoration	mon	monochrome	undec	undecorated
		out	outer		
eng	engobe	pol	polished		
gl	glaze / glazed	pnt	painted		
in	inner	rng	running		

SITE 1 (JANAVLATTEPA)

1 Body *fr.* *Rd* ?, *pht* 0.045. *Rng* coal-black *sl*, *out surf rng dec*: skewed grid square motif.

2 Body *fr.* *Rd* ?, *ext ht* 0.062. Ochre/brown fabric, yellowish *sl* on *out surf*.

3 Body *fr.* *Rd* ?, *ext ht* 0.031. *Surf* ochre/brown. *Rsd* of coal on fracture.

4 *Comp* base and *pt* of body. *Bd* 0.11, *ext ht* 0.042. Orange/brownish fabric, yellowish *sl* on *out surf*, *inc horiz lin dec* on *out surf*.

SITE 2 (BOSHTEPA)

5 Rim *fr.* *Rd* 0.09, *ext ht* 0.041. Brick-red fabric, *rsd* of *RS*. *CW*.

6 Rim *fr.* *Rd* 0.13, *ext ht* 0.038. Core and *surf* orange, *RS*. *CW*.

7 *Hdl* and rim *fr.* *Rd* 0.14, *pht* 0.144. Yellow fabric core with orange margins, orange/yellow *surf*, *inc horiz lin dec* on *out surf*.

8 Rim *fr.* *Rd* 0.2, *ext ht* 0.05. Brick-red fabric, ochre *eng* on *out surf*.

9 Rim *fr.* *Rd* 0.04, *ext ht* 0.016. Brick-red fabric, ochre *eng* on *surf*.

10 Rim *fr.* *Rd* 0.2, *ext ht* 0.05. Orange fabric, orange *eng* on *out surf*, strip of brown *sl* on *in surf*.

11 Rim *fr.* *Rd* 0.27, *ext ht* 0.035. Yellow/brown fabric, ochre *eng* on *surf*.

12 Rim *fr.* *Rd* 0.36, *ext ht* 0.078. Orange/brick-red fabric, ochre *eng* on *out surf*, inclusion size up to 0.005.

13 Rim *fr.* *Rd* 0.3, *ext ht* 0.141. Brick-red fabric, greenish/ochre *eng* on *surf*. Pink, ochre and brown stains on *in surf*.

14 Rim *fr.* *Rd* 0.38, *ext ht* 0.081. Ochre fabric with brick-red margins, brick-red *surf*.

15 Body *fr.* *Pht* 0.065. Rather deep comb *dec* on whole *surf*, pale brown fabric, *out surf* pale brown to orange/yellow.

16 Body *fr.* *Pht* 0.038. Fabric description identical to [15].

17 Body *fr* with *hdl*. *Pht* 0.078. Dark red/brown fabric, brownish to red *out surf*, *WR*.

18 Body *fr.* *Pht* 0.034. Brown fabric, concentric circles of lustrous brown, green and yellow *gl*.

19 Body *fr.* *Pht* 0.046. Orange/brown fabric, *in surf* yellow/ochre; yellow and white floral *sl* in *out surf*.

- 20 Body *fr.* *Pht* 0.044. Red fabric; *in surf* red and grey; *out surf* yellow and white *sl* and indistinctive chisel pattern.
- 21 Body *fr.* of unsure orientation. *Pht* 0.108. Black fabric with grey stains; *out surf* red with grey stains; Plastic *rng dec.*
- 22 Body *fr.* *Pht* 0.037. Brown fabric; lustrous *gl* on *surf.*
- 23 Body *fr.* *Pht* 0.056. Brick-red fabric, core slightly paler.
- 24 Body *fr.* *Pht* 0.026. Fabric description identical to [23].
- 25 Body *fr.* *Pht* 0.043. Pale brown fabric; *out surf* pale brown to orange/yellow; rather deep *comb dec* on whole *surf.*
- 26 Body *fr.* *Pht* 0.033. For fabric description see [25].
- 27 Body *fr.* *Pht* 0.029. For fabric description see [25].
- 28 Body *fr.* *Pht* 0.032. For fabric description see [25].
- 29 Body *fr.* *Pht* 0.03. Orange fabric, *out surf* yellow/white with yellow *sl* and *crvl comb dec.*
- 30 Body *fr.* *Pht* 0.034. Brown fabric, yellowish *surf*, floral *dec* on *out surf.*
- 31 Body *fr.* *Pht* 0.096. Pale brown fabric, *out surf* pale brown to orange/yellow; occasional *comb dec* (grid).
- 32 Body *fr.* with *hdl pt.* *Pht* 0.132. Yellow fabric with red margins, *in surf* red and grainy; orange *eng* on *out surf*; skewed grid *dec.*
- 33 Body *fr.* *Pht* 0.059. Orange/red fabric, *in surf* half orange, half brown; shallow floral *dec.*
- 34 *Hdl fr.* *W* 0.054 x 0.023. Ochre to orange fabric; yellowish *sl.*
- 35 *Hdl fr.* *W* 0.055 x 0.02. For fabric description see [34].
- 36 *Hdl fr.* *W* 0.03 x 0.012. Brick-red fabric; *rsd* of ochre *eng.*
- 37 *Hdl fr.* *W* 0.026 x 0.011. Carmine fabric.
- 38 Base *fr.* *Bd* 0.09, *ext ht* 0.079. Dark red fabric, ochre *eng* on *out surf.*

SITE 3 (KOSHTEPA I)

- 39 Rim *fr.* *Rd* 0.08, *ext ht* 0.025. Brick-red fabric, ochre *eng* on *out surf.*
- 40 Rim *fr.* *Rd* 0.07, *ext ht* 0.037. Orange fabric, brick red on *surf.*
- 41 Rim *fr.* *Rd* 0.05, *ext ht* 0.046. Brick-red fabric; inclusion size up to 0.001.
- 42 Rim *fr.* *Rd* 0.21, *ext ht* 0.06. Brown fabric; ocre/green *eng* on *out surf*; inclusion size up to 0.001.
- 43 Rim *fr.* *Rd* 0.17, *ext ht* 0.076. Brown fabric and *out surf*, yellow/brown *in surf.*
- 44 Rim *fr.* *Rd* 0.33, *ext ht* 0.058. Brick-red fabric, ocre/greenish *eng* on *out surf.*

SITE 4 (KULUG-SHAKHTEPA)

- 45 Rim *fr. Rd* ?, *ext ht* 0.018. Very fine, pale brown/pinkish fabric, *RS*.
- 46 Rim *fr. Rd* ?, *ext ht* 0.028. Pale brown fabric, light blue *gl*.
- 47 Rim *fr. Rd* ?, *ext ht* 0.022. Pale brown fabric, blue/green *gl*.
- 48 Rim *fr. Rd* ?, *ext ht* 0.029. Fine, pale brown fabric; coarse light blue *sl*.
- 49 Rim *fr. Rd* 0.08, *ext ht* 0.025. Fine, pale brown fabric, *rsd* of dark brown *sl*.
- 50 Rim *fr. Rd* 0.065, *ext ht* 0.033. Coarse yellow/brown fabric, pale brown on fracture.
- 51 Rim *fr. Rd* 0.14, *ext ht* 0.026. Orange/brown fabric, brown and white *surf*.
- 52 Rim *fr. Rd* 0.19, *ext ht* 0.028. Fine pale brown fabric.
- 53 Rim *fr. Rd* 0.13, *ext ht* 0.021. Orange/red fabric.
- 54 Rim *fr. Rd* 0.17, *ext ht* 0.019. Fine pale brown fabric; fine inclusions.
- 55 Rim *fr. Rd* ?, *ext ht* 0.018. Coarse brown/pale brown fabric.
- 56 Rim *fr. Rd* ?, *ext ht* 0.043. Orange fabric, pale brown core.
- 57 Rim *fr. Rd* 0.05, *ext ht* 0.053. Orange/brown fabric, brown and white *surf*.
- 58 Rim *fr. Rd* 0.22, *ext ht* 0.032. Red fabric, light brown *surf*.
- 59 Rim *fr. Rd* 0.23, *ext ht* 0.032. Orange/brown fabric, dark *RS*.
- 60 Rim *fr. Rd* 0.26, *ext ht* 0.021. Fine orange fabric, *RS*.
- 61 Rim *fr. Rd* 0.27, *ext ht* 0.041. Fine, red fabric, pale yellow/brown *out surf*.
- 62 Rim *fr. Rd* 0.34, *ext ht* 0.038. Fine, pale orange/brown fabric.
- 63 Rim *fr. Rd* 0.36, *ext ht* 0.021. Fine, pale yellow/brown fabric, light blue *gl*.
- 64 Rim *fr. Rd* 0.34, *ext ht* 0.046. Orange/red fabric, brown/grey *surf*.
- 65 Rim *fr. Rd* 0.2, *ext ht* 0.037. Yellow/brown fabric, red/pinkish on fracture.
- 66 Base *fr. Bd* 0.04, *ext ht* 0.031. Fine, grey fabric, black *sl* on *out surf*.

SITE 5 (AKTEPA)

- 67 Rim *fr. Rd* 0.21, *ext ht* 0.028. Fine, pale orange fabric, originally *RS* (*in surf* and upper section of *out surf*), *pol dec* on *in surf*.
- 68 Rim *fr. Rd* 0.19, *ext ht* 0.019.
- 69 Rim *fr. Rd* 0.045, *ext ht* 0.028. Orange fabric, *rsd* of orange *sl* on *out surf*.
- 70 Rim *fr. Rd* 0.06, *ext ht* 0.018. Fine, pale orange fabric, yellowish *sl*.

- 71 Rim *fr.* *Rd* 0.09, *ext ht* 0.031. Fine, orange fabric, *rsd* of *RS* on *in surf*, yellowish *sl* on *out surf*.
- 72 Rim *fr.* *Rd* 0.21-0.22, *ext ht* 0.029. Orange/brown fabric, *rsd* of *RS* on *out surf*.
- 73 Rim *fr.* *Rd* 0.22, *ext ht* 0.026. Pale orange fabric; white/yellow *sl* on *out surf*.
- 74 Rim *fr.* *Rd* 0.22, *ext ht* 0.016. Fine, orange/grey fabric, *RS* on *in surf*, red/brownish *sl* on *out surf*.
- 75 Rim *fr.* *Rd* 0.12, *ext ht* 0.019.
- 76 Rim *fr.* *Rd* ?, *ext ht* 0.04. Disrupted surf, beige/orange fabric, paler on *surf*.
- 77 Rim *fr.* *Rd* 0.06, *ext ht* 0.029. Dark grey fabric.
- 78 Rim *fr.* *Rd* 0.28, *ext ht* 0.025. Orange fabric, yellowish *sl* on *in surf*, whitish *sl* on *out surf*.
- 79 Rim *fr.* *Rd* 0.07, *ext ht* 0.028. Pale orange fabric, *rsd* of brown *sl*.
- 80 Rim *fr.* *Rd* 0.25, *ext ht* 0.053. Brownish/orangish fabric, white/yellow *sl* on *out surf*.
- 81 Rim *fr.* *Rd* 0.05, *ext ht* 0.051. Fine, pale orange fabric, *rds* of *RS*/brown *sl*.
- 82 Rim *fr.* *Rd* 0.17, *ext ht* 0.038. Brown/ochre fabric.
- 83 Rim *fr.* *Rd* 0.18, *ext ht* 0.037. Orange fabric.
- 84 Rim *fr.* *Rd* 0.2, *ext ht* 0.052. Brick red fabric, black *sl* on *out surf*.
- 85 Rim *fr.* *Rd* 0.08, *ext ht* 0.041.
- 86 Rim *fr.* *Rd* 0.07, *ext ht* 0.045. Brick red fabric.
- 87 Rim *fr.* *Rd* 0.08, *ext ht* 0.057. Orange/red fabric, *rds* of *RS* on *out surf*.
- 88 Rim *fr.* *Rd* 0.12, *ext ht* 0.025. Grey fabric, dark brick red *surf*. *Cf.*
- 89 Rim *fr.* *Rd* 0.11, *ext ht* 0.03. Beige fabric, orange *in surf*. *Cf.*
- 90 Rim *fr.* *Rd* 0.33, *ext ht* 0.066. Orange fabric, yellow/white *sl* on *out surf*.
- 91 Rim *fr.* *Rd* 0.29, *ext ht* 0.073. Orange fabric, yellow *sl* on *out surf*.
- 92 Rim *fr.* *Rd* 0.13, *ext ht* 0.025. Orange fabric, pale orange *surf*.
- 93 Rim *fr.* *Rd* 0.16, *ext ht* 0.016. Orange fabric, *RS* on both *surf*. *FW.*
- 94 Rim *fr.* *Rd* 0.1, *ext ht* 0.019. Orange/grey fabric, grey *surf*.
- 95 Rim *fr.* *Rd* 0.18, *ext ht* 0.025. Pale orange fabric; dark orange *sl* on *in* and partially *out surf*; orangish/whitish slip on *out surf*.
- 96 Rim *fr.* *Rd* 0.15, *ext ht* 0.021. Orange fabric; *rsd* of dark orange *sl*.
- 97 Rim *fr.* *Rd* 0.17, *ext ht* 0.027. Orange/brown fabric; yellowish *sl* on *out surf*; perforated.
- 98 Rim *fr.* *Rd* 0.11, *ext ht* 0.097. Orange fabric; ochre/yellowish *surf*.
- 99 Rim *fr.* *Rd* 0.11, *ext ht* 0.061. Orange fabric; ochre/yellowish *surf*.

100 Rim *fr.* *Rd* 0.08, *ext ht* 0.075. Orange fabric.

101 Rim *fr.* *Rd* 0.17, *ext ht* 0.021. Orange fabric and *surf.*

102 Rim *fr.* *Rd* 0.18, *ext ht* 0.022. Brown/orange fabric; white/yellow *surf.*

103 Rim *fr.* *Rd* 0.09, *ext ht* 0.027. Pale orange/brown fabric; *rsd* of *RS*.

104 Rim *fr.* *Rd* 0.1, *ext ht* 0.027. Pale orange fabric and *surf.*

105 Rim *fr.* *Rd* 0.095, *ext ht* 0.023. Orange fabric; brownish *surf.*; *RS*.

106 Rim *fr.* *Rd* 0.09, *ext ht* 0.026. Grey fabric; red/grey *surf.*

107 Rim *fr.* *Rd* 0.13, *ext ht* 0.029. Pale orange fabric; *RS*.

108 Rim *fr.* *Rd* 0.13, *ext ht* 0.03. Grey fabric; brick-red *in surf.*; *out surf* grey with dark grey stripe below rim.

109 Rim *fr.* *Rd* 0.14, *ext ht* 0.029. Pale orange fabric.

110 Rim *fr.* *Rd* ?, *ext ht* 0.028. Pale orange fabric; brown *sl* on *in surf.*; yellow/white *sl* on *out surf.*

111 Rim *fr.* *Rd* ?, *ext ht* 0.031. Beige/pale orange fabric; *RS*.

112 Rim *fr.* *Rd* ?, *ext ht* 0.029. *Cf.*

113 *Hdl fr.* *W* 0.018 x 0.013.

114 Body *fr.* *Pht* 0.079. Orange/pink fabric; yellowish *sl* and stains of runned-down brown *sl* on *out surf.*

115 Body *fr.* *Pht* 0.072. Orange/grey fabric; *in surf* grey to brown/orange; grey and *rsd* of black *sl* on *out surf.*

116 Body *fr.* *Pht* 0.034. Beige/ochre fabric; pale brownish *sl* on *out surf.*

117 Body *fr.* *Pht* 0.045. Orange/brown fabric; thin, dim orange *sl*.

118 Base *fr.* *Bd* 0.05, *ext ht* 0.01. Orange fabric; pale orange *out surf* with *rsd* of *RS*.

119 Base *fr.* *Bd* 0.039, *ext ht* 0.008. Beige/ochre fabric.

120 Base *fr.* *Bd* 0.052, *ext ht* 0.021. Orange/brick-red fabric; *rsd* of orange *sl* on *in surf.*

121 Base *fr.* *Bd* 0.1, *ext ht* 0.025. Pale orange fabric; yellow *sl* on *out surf.*

122 Base *fr.* *Bd* 0.05, *ext ht* 0.022.

123 Base *fr.* *Bd* 0.09, *ext ht* 0.032.

124 Base *fr.* *Bd* 0.045, *ext ht* 0.019. Very fine, pale orange fabric; red *gl* with *pol floral dec* on *in surf.*

SITE 6

125 Rim *fr. Rd* 0.165, *ext ht* 0.021. Corroded *in surf*; pink and red stains on *out surf*.

126 Body *fr. D* at bulge 0.08, *pht* 0.037. Brick-red fabric; ochre eng on surf.

127 Body *fr. Pht* 0.061. Brick-red fabric; ochre eng on *out surf. CW*.

128 Body *fr. Pht* 0.074. For fabric description see [127].

129 *Hdl fr. W* 0.022 x 0.005. Orange fabric; ochre eng on *surf*.

130 Base *fr. Bd* 0.087, *ext ht* 0.011. Brick-red fabric; ochre eng on *out surf*; distinctive *WR*, roughing on base.

131 Base *fr. Bd* 0.12, *ext ht* 0.043. Brick-red/yellow fabric; creamy yellow *surf*; *HM* base. *CW/KW*.

132 Base *fr. Bd* 0.08, *ext ht* 0.041. Yellow fabric with brown spots; yellow *surf*; distinctive *WR*; impressed conch at the bottom.

133 Base *fr. Bd* ?, *ext ht* 0.035. Brick-red/yellow fabric, *out surf* orange/brown.

SITE 7 (KOSHTEPA II)

134 Rim *fr. Rd* 0.45, *ext ht* 0.135. Brown/yellow fabric; red eng on *out surf*.

135 Rim *fr. Rd* 0.12, *ext ht* 0.028. Brown fabric; ochre *surf*; *rsd* of *RS* on *in surf*.

136 Rim *fr. Rd* 0.08, *ext ht* 0.047. Brown fabric; ochre eng on *surf*.

137 Rim *fr. Rd* 0.1, *ext ht* 0.035. Ochre fabric.

138 Rim *fr. Rd* 0.4, *ext ht* 0.048. Orange fabric; ochre eng and *rsd* of *RS* on *surf*.

SITE 8 (BATYRABADTEPA)

139 Rim *fr. Rd* 0.21, *ext ht* 0.057. Brown fabric; black *surf*; distinctive *WM*.

140 Rim *fr. Rd* 0.3, *ext ht* 0.03. Red-orange fabric.

141 Rim *fr. Rd* 0.34, *ext ht* 0.05. Orange fabric; *out surf* ochre/red.

142 Rim *fr. Rd* 0.4, *ext ht* 0.133. Brick-red fabric; ochre, black and orange stains on *out surf*.

143 Rim fr. Rd ?, ext ht 0.017. Brick-red fabric; ochre eng on both surf.

144 Rim fr. Rd ?, ext ht 0.025. Orange fabric.

145 Rim fr. Rd ?, ext ht 0.034. Brick-red fabric; ochre eng on out surf; WR.

146 Rim fr. Rd 0.12, ext ht 0.015. Brick-red fabric.

147 Rim fr. Rd 0.112, ext ht 0.027. Brick red fabric; ochre eng on out surf.

148 Rim fr. Rd 0.29, ext ht 0.042. Brick-red fabric; ochre eng of with rsd of RS.

149 Rim fr. Rd 0.16, ext ht 0.027. Grey/black fabric; brick-red surf.

150 Rim fr. Rd 0.08, ext ht 0.034. Brick-red fabric; ochre eng on out surf.

151 Hdl fr. W 0.038 x 0.017. Brick-red fabric; ochre eng on both surf.

152 Hdl fr. W 0.037 x 0.014. Orange fabric; ochre eng with rsd of RS on both surf.

153 Body fr. Pht 0.062. Red fabric; in surf brown/red; out surf brown; inclusion size up to 0.002.

154 Base fr. Bd 0.06, ext ht 0.008. Brick-red fabric; out surf ochre; surf sooted.

155 Base fr. Bd 0.05, ext ht 0.021. Brick-red fabric; WR.

156 Base fr. Bd 0.08, ext ht 0.018. Orange fabric; ochre eng on both surf; WR.

SITE 9 (KHOJA QAPTOL BOBO)

157 Rim fr. Rd ?, ext ht 0.064. Coarse, dark grey fabric; beige, sporadically greenish on surf.

SITE 10 (KATTATEPA)

158 Compl vsl. Rd 0.066, ht 0.052. WR; supposedly secondary used.

159 Rim fr. Rd 0.08, ext ht 0.017.

160 Rim fr. Rd 0.09, ext ht 0.054.

161 Rim fr. Rd 0.1, ext ht 0.056.

162 Rim fr. Rd 0.14, ext ht 0.034.

163 Rim fr. Rd 0.09, ext ht 0.036. Black fabric; brown surf; RS on surf.

164 Rim fr. Rd 0.17, ext ht 0.057. Brick-red fabric; RS on surf.

165 Rim fr. Rd 0.16, ext ht 0.046. RS on surf; WR.

166 Rim fr. Rd 0.08, ext ht 0.025. RS on surf.

167 Rim fr. Rd 0.12, ext ht 0.024. Dark brown fabric; ochre eng on out surf.

168 Rim fr. Rd 0.1, ext ht 0.021. RS; WR.

169 Rim fr. Rd 0.07, ext ht 0.023. RS.

170 Rim *fr. Rd* 0.24, *ext ht* 0.042. Brick-red fabric.

171 Rim *fr. Rd* 0.25, *ext ht* 0.064. RS.

172 Rim *fr. Rd* ?, *ext ht* 0.087. Brick-red *out surf*; WR.

173 Rim *fr. Rd* 0.4, *ext ht* 0.038. Brown *in surf*.

174 Rim *fr. Rd* 0.34, *ext ht* 0.07.

175 Rim *fr. Rd* 0.3, *ext ht* 0.034.

176 Rim *fr. Rd* 0.22, *ext ht* 0.039. Brick-red fabric; ochre *eng* on *surf*.

177 Rim *fr. Rd* 0.1, *ext ht* 0.046. *Rsd* of RS; WR.

178 Rim *fr. Rd* 0.16, *ext ht* 0.032. Brick-red fabric; *out surf* ochre; *rsd* of RS on *in surf*.

179 Rim *fr. Rd* 0.15, *ext ht* 0.023. Brick-red fabric; ochre *eng* on both *surf*; *rsd* of RS.

180 Rim *fr. Rd* 0.18, *ext ht* 0.04. RS.

181 Body *fr. Pht* 0.11. RS; WR.

182 Body *fr. Pht* 0.086. Painted *dec* (red stripe).

183 Body and *hdl fr. Pht* 0.103. RS.

184 Base *fr. Bd* 0.06, *ext ht* 0.011. RS; WR.

185 Base *fr. Bd* 0.11, *ext ht* 0.032. *In surf* unpreserved.

SITE 11

186 Rim *fr. Rd* 0.07, *ext ht* 0.045. Orange fabric; *in surf* yellow; dark red *eng* on *out surf*; WR.

187 Rim *fr. Rd* 0.1, *ext ht* 0.03. Orange fabric; *out surf* carmine red.

188 Rim *fr. Rd* 0.1, *ext ht* 0.024. Brick-red fabric.

189 Rim *fr. Rd* 0.09, *ext ht* 0.015.

190 Rim *fr. Rd* 0.06, *ext ht* 0.028. Ochre fabric; black *eng* on *out surf*; inclusion size up to 0.0005; distinctive RW.

191 Rim *fr. Rd* 0.18, *ext ht* 0.04. Brick-red fabric; ochre *eng* on *out surf*.

192 Rim *fr. Rd* 0.21, *ext ht* 0.035.

SITE 12

193 Rim *fr. Rd* 0.12, *ext ht* 0.027. Fine, orange/reddish fabric.

194 Rim *fr. Rd* 0.17, *ext ht* 0.03. Fine, pale brown fabric.

195 Rim *fr. Rd* 0.15, *ext ht* 0.021. Brown fabric, darker on *in surf*.

196 Rim *fr. Rd* 0.15, *ext ht* 0.037. Brown poriferous fabric; greenish brown on *out surf*.

197 Rim *fr. Rd* 0.19, *ext ht* 0.02. Fine, yellow/brown fabric, reddish on fracture.

198 Rim *fr.* *Rd* 0.14, *ext ht* 0.019. *Out surf* grey/greenish; *in surf* orange/brownish; tiny inclusions.

199 Rim *fr.* *Rd* 0.1, *ext ht* 0.017. Yellow/brownish fabric; RS.

200 Rim *fr.* *Rd* 0.25, *ext ht* 0.021. Red fabric, yellow/brownish on fracture.

201 Rim *fr.* *Rd* 0.24, *ext ht* 0.028. Dark red fabric; pale brown *surf*, tiny inclusions.

202 Rim *fr.* *Rd* 0.25, *ext ht* 0.034. Reddish and yellow/brownish fabric.

203 Rim *fr.* *Rd* 0.34, *ext ht* 0.051. Fine orange fabric; brown/yellow *sl* on *out surf*; *inc crvl dec* on *in surf*.

204 Rim *fr.* *Rd* 0.03, *ext ht* 0.018. Grey fabric; tiny orange/reddish inclusions.

205 Rim *fr.* *Rd* ?, *ext ht* 0.028. Pinking/brown fabric; *out surf* yellow/brownish.

206 Rim *fr.* *Rd* 0.08, *ext ht* 0.03. Dark brown fabric; *out surf* pale brown; tiny inclusions.

207 Lid *fr* with *hdl.* *Max hdl d* 0.05, *ext ht* 0.028. Orange/reddish fabric, brown on fracture.

208 Base *fr.* *Bd* 0.05, *ext ht* 0.021. Poriferous pale brown/orangish fabric.

SITE 16 (SHORTEPA)

209 Rim *fr.* *Rd* 0.18, *ext ht* 0.029. RS on *out surf*.

210 Rim *fr.* *Rd* 0.06, *ext ht* 0.025. Brown fabric, ochre on *surf*.

211 Rim *fr.* *Rd* 0.06, *ext ht* 0.037. *Eng* on *surf*.

212 Rim *fr.* *Rd* 0.08, *ext ht* 0.045. Ochre fabric.

213 Rim *fr.* *Rd* 0.2, *ext ht* 0.033. Brick-red fabric.

214 Rim *fr.* *Rd* 0.19, *ext ht* 0.037. Brown fabric; ochre *eng* with *rsd* of RS on *out surf*.

215 Rim *fr.* *Rd* ?, *ext ht* 0.051. Brick-red fabric; unsure orientation.

216 Rim *fr.* *Rd* 0.11, *ext ht* 0.03. Orange fabric; *out surf* yellow.

217 Rim *fr.* *Rd* 0.12, *ext ht* 0.03. RS; WR.

218 Rim *fr.* *Rd* 0.08, *ext ht* 0.028.

219 Rim *fr.* *Rd* 0.14, *ext ht* 0.023. Brown fabric, ochre *eng*.

220 Rim *fr.* *Rd* 0.11, *ext ht* 0.028.

221 Rim *fr.* *Rd* 0.09, *ext ht* 0.029. RS on *out surf*.

222 Rim *fr.* *Rd* 0.13, *ext ht* 0.031. Brown fabric; *in surf* ochre; brown *eng* on *out surf*.

223 Rim *fr.* *Rd* 0.11, *ext ht* 0.037. Yellow fabric.

224 Rim *fr.* *Rd* 0.1, *ext ht* 0.049.

- 225 Rim *fr.* *Rd* 0.14, *ext ht* 0.02.
- 226 Rim *fr.* *Rd* 0.16, *ext ht* 0.017. Black/grey fabric; *rsd* of black *sl*.
- 227 Rim *fr.* *Rd* 0.18, *ext ht* 0.023.
- 228 Rim *fr.* *Rd* 0.17, *ext ht* 0.02. Grey fabric; ochre *eng* on *surf*.
- 229 Rim *fr.* *Rd* 0.24, *ext ht* 0.014. Brown fabric; *out surf* grey.
- 230 Rim *fr.* *Rd* 0.1, *ext ht* 0.026. Eng on *surf*.
- 231 Rim *fr.* *Rd* 0.34, *ext ht* 0.067. Brown fabric; *RS* on *in surf*; ochre *eng* on *out surf*.
- 232 Rim *fr.* *Rd* 0.36, *ext ht* 0.025. Eng on *surf*.
- 233 Rim *fr.* *Rd* ?, *ext ht* 0.023. Brown fabric; ochre *eng* on *out surf*; ochre *eng* and *rsd* of *RS* on *in surf*; unsure orientation.
- 234 Rim *fr.* *Rd* ?, *ext ht* 0.028. Brick-red fabric.
- 235 Rim *fr.* *Rd* ?, *ext ht* 0.013. Brick-red fabric; ochre *eng* on *surf*.
- 236 Rim *fr.* *Rd* ?, *ext ht* 0.012.
- 237 Rim *fr.* *Rd* ?, *ext ht* 0.012.
- 238 Rim *fr.* *Rd* ?, *ext ht* 0.107.
- 239 Body and *hdl fr.* *Pht* 0.067.
- 240 Body *fr.* *Pht* 0.026. Brick-red fabric; ochre *eng* on *out surf*; *in surf* unpreserved.
- 241 Body *fr.* *Pht* 0.02. Brown fabric; ochre *eng* on *surf*.
- 242 Body *fr.* *Pht* 0.042. Orange fabric; ochre *eng* on *surf*.
- 243 *Hdl fr.* *W* 0.024 x 0.019. Brick-red fabric; yellow *eng* on *surf*.
- 244 *Hdl fr.* *W* 0.031 x 0.016. Brown fabric; ochre *eng* on *surf*.
- 245 *Hdl fr.* *W* 0.038 x 0.016. Brick-red fabric; ochre *eng* on *surf*.
- 246 *Hdl fr.* *W* 0.034 x 0.015. For fabric description see [245].
- 247 *Hdl fr.* *W* 0.029 x 0.01. For fabric description see [244].
- 248 Base *fr.* *Bd* ?, *ext ht* 0.008. Brick-red fabric; ochre *eng* on *out surf*; *in surf* unpreserved.
- 249 Base *fr.* *Bd* ?, *ext ht* 0.031. Brick-red fabric.
- 250 Base *fr.* (?). *Bd* ?, *ext ht* 0.023. Brick-red fabric; supposedly shattered base *fr*.
- 251 Base *fr.* *Bd* 0.04, *ext ht* 0.007. Brick-red fabric; *in surf* unpreserved.
- 252 Base *fr.* *Bd* 0.04, *ext ht* 0.026. Brick-red fabric; ochre *eng* on *out surf*; *in surf* unpreserved.
- 253 Base *fr.* *Bd* 0.06, *ext ht* 0.018. Brick-red fabric; ochre *eng* on *in surf*; impressed conch on the bottom.
- 254 Base *fr.* *Bd* 0.11, *ext ht* 0.027. Ochre *eng* on *surf*.
- 255 Base *fr.* *Bd* 0.11, *ext ht* 0.034.
- 256 Base *fr.* *Bd* 0.11, *ext ht* 0.021. WR.
- 257 Base *fr.* *Bd* 0.12, *ext ht* 0.049.

SITE 17 (SHISHTEPA)

- 258 Rim *fr.* *Rd* 0.35, *ext ht* 0.055. Brick-red fabric.
- 259 Rim *fr.* *Rd* 0.4, *ext ht* 0.053. Brick-red fabric; yellowish/ochre *sl* on *out surf*; *rsd* of brown/white *sl* on *in surf*.
- 260 Rim *fr.* *Rd* 0.42, *ext ht* 0.074. Orange fabric; yellowish on *surf*; plastic *crvl dec*.
- 261 Rim *fr.* *Rd* 0.09, *ext ht* 0.025. Brick-red fabric.
- 262 Rim *fr.* *Rd* 0.09, *ext ht* 0.038. Brown/red fabric; yellow/brown *surf*.
- 263 Rim *fr.* *Rd* 0.07, *ext ht* 0.026. Orange fabric; *sl* (darker on *out surf*).
- 264 Rim *fr.* *Rd* 0.065, *ext ht* 0.017. Pale orange fabric, brownish on *out surf*; *RS*.
- 265 Rim *fr.* *Rd* 0.23, *ext ht* 0.061. Red/greyish fabric, grey on fracture.
- 266 Rim *fr.* *Rd* 0.28, *ext ht* 0.03. Dark red fabric; orange *gl*; *in surf* unpreserved.
- 267 Rim and *hdl fr.* *Rd* 0.03, *ext ht* 0.027, *hdl w* 0.028 x 0.013. Orange fabric; *RS* on both *surf*.
- 268 Body *fr.* *Ph* 0.036. Pale orange fabric; yellow stain on *out surf*.

SITE 18 (GILYAMBOBTEPA)

- 269 Rim *fr.* *Rd* ?, *ext ht* 0.042. Brown fabric; ochre *eng*.
- 270 Rim *fr.* *Rd* ?, *ext ht* 0.041. Brick-red fabric; ochre *eng* on *out surf*; upper part sooted; inclusion size up to 0.005.
- 271 Rim *fr.* *Rd* ?, *ext ht* 0.031. Pale brown fabric, *out surf* dark brown.
- 272 Rim *fr.* *Rd* 0.2, *ext ht* 0.149. Grey fabric, *out surf* red.
- 273 Rim *fr.* *Rd* 0.16, *ext ht* 0.107. Brown/orange fabric, *in surf* orange; ochre *eng* on *out surf*; stain of *RS*.
- 274 Rim *fr.* *Rd* 0.18, *ext ht* 0.031. *RS*.
- 275 Rim *fr.* *Rd* 0.13, *ext ht* 0.035. *RS* on *out surf*.
- 276 Rim *fr.* *Rd* 0.14, *ext ht* 0.028. Brown fabric; brown *eng* on *out surf*; red *eng* on *in surf*.
- 277 Rim *fr.* *Rd* 0.1, *ext ht* 0.029. Brown fabric; ochre *eng* on *out surf*.
- 278 Rim *fr.* *Rd* 0.1, *ext ht* 0.043. Sandwich fabric: brown margins, orange core; brown on *surf*.
- 279 Rim *fr.* *Rd* 0.09, *ext ht* 0.042. Brick-red fabric.
- 280 Rim *fr.* *Rd* 0.09, *ext ht* 0.049. Brick-red fabric; ochre *eng* on *out surf*.

281 Rim *fr.* *Rd* 0.16, *ext ht* 0.048. Brick-red fabric; ochre *eng* on *in surf*.

282 Rim *fr.* *Rd* 0.4, *ext ht* 0.077. Brick-red fabric; red *eng* on *out surf*.

283 Rim *fr.* *Rd* 0.4, *ext ht* 0.045. Brown fabric; ochre *eng* on *surf*.

284 Rim *fr.* *Rd* 0.1, *ext ht* 0.036. Ochre fabric; RS.

285 Rim *fr.* *Rd* 0.09, *ext ht* 0.037. Yellow fabric; brown *sl* on *out surf*.

286 Rim *fr.* *Rd* 0.07, *ext ht* 0.032. Orange fabric; RS on *out surf*.

287 Body *fr.* *Pht* 0.031. Brick-red fabric; ochre *eng* on *surf*.

288 Body *fr.* *Pht* 0.051. Brown fabric; RS on *out surf*.

289 *Hdl fr.* *Pht* 0.033, *w* 0.04 x 0.011. Orange fabric; ochre *eng* on *out surf*; *rsd* of RS.

290 *Hdl fr.* *Pht* 0.029, *w* 0.041 x 0.012. Orange/yellow fabric; ochre *eng* on *surf*; *rsd* of RS in upper part.

291 Base *fr.* *Bd* 0.04, *ext ht* 0.016. Brown fabric; RS on *out surf*.

292 Base *fr.* *Bd* 0.11, *ext ht* 0.048. Sandwich fabric: orange margins, yellow core; yellow *surf*; attached nib.

SITE 19 (GORINTEPA)

293 Rim *fr.* *Rd* ?, *ext ht* 0.052. Red fabric with inclusions; *in surf* orange; *out surf* panned.

294 Rim *fr.* *Rd* ?, *ext ht* 0.037. Orange/red fabric; ochre *eng* on *out surf*.

295 Rim *fr.* *Rd* ?, *ext ht* 0.026. RS.

296 Rim *fr.* *Rd* ?, *ext ht* 0.026. Orange fabric; *in surf* yellow; ochre *eng* on *out surf*.

297 Rim *fr.* *Rd* 0.106, *ext ht* 0.033. RS.

298 Rim *fr.* *Rd* 0.46, *ext ht* 0.08. Red/brown fabric; ochre *eng* on *out surf*.

299 *Handle fr.* *W* 0.043 x 0.016. Orange fabric; creamy yellow *surf*.

300 Body and *hdl fr.* *horiz sec.* *Hdl w* 0.019 x 0.014. Orange fabric; *in surf* creamy yellow; RS.

SITE 22 (TAUSHKANTEPA)

301 Rim *fr.* *Rd* 0.4, *ext ht* 0.073. Brick-red fabric; ochre *eng* on *out surf*.

302 Rim *fr.* *Rd* 0.4, *ext ht* 0.087. For fabric description see [301].

303 Rim *fr.* *Rd* 0.22, *ext ht* 0.05. Red fabric, *out surf* brown; inclusion size up to 0.007.

304 Rim *fr.* *Rd* ?, *ext ht* 0.087. Sandwich fabric: brick-red margins, black core; brown

eng on surf; limestone inclusion size up to 0.005.

305 Rim *fr. Rd* ?, *ext ht* 0.035. Carmine fabric, *in surf* brick-red; ochre *eng on out surf*.

306 Rim *fr. Rd* 0.16, *ext ht* 0.016. Brick-red fabric; *rsd* of *RS* on *out surf*.

307 Rim *fr. Rd* 0.19, *ext ht* 0.065. For fabric description see [306].

308 Rim *fr. Rd* 0.08, *ext ht* 0.053. Brick-red fabric.

309 Body *fr. Pht* 0.097. Brick-red fabric; *rsd* of *RS* on *out surf*; *CR*.

310 *Hdl fr. W* 0.035 x 0.011. Brick-red fabric, ochre *surf*.

SITE 23 (TASHLAKTEPA)

311 Rim *fr. Rd* 0.26, *ext ht* 0.04. Pale red fabric; yellow *eng on out surf*; *WR*.

312 Rim *fr. Rd* 0.12, *ext ht* 0.028. Grey fabric, *out surf* red, *in surf* brown.

313 Rim *fr. Rd* 0.04, *ext ht* 0.026. Orange fabric; white *eng on surf*.

314 Rim *fr. Rd* 0.09, *ext ht* 0.022. Pale brown fabric; yellow *eng on surf*.

315 Rim *fr. Rd* 0.23, *ext ht* 0.084. Grey fabric, *out surf* brown, *in surf* grey/purple; inclusion size up to 0.003.

316 Rim *fr. Rd* 0.4, *ext ht* 0.088. Red fabric; ochre *eng on out surf*; inclusion size up to 0.002.

317 Rim *fr. Rd* 0.2, *ext ht* 0.116. Brick-red fabric; ochre *eng on out surf*.

318 Body *fr. Pht* 0.056. Brick-red fabric.

319 Body *fr. Pht* 0.103. Brick-red fabric, *out surf* orange/yellow.

320 Body *fr. Pht* 0.024. Brick-red fabric, *in surf* ochre; blue and white *gl on out surf*.

321 Body *fr. Pht* 0.021. Yellow fabric.

322 Body *fr. Pht* 0.025. Brick-red fabric.

323 *Hdl fr. W* 0.042 x 0.015. Brick-red fabric; yellow *eng on surf*.

324 *Hdl fr. W* 0.044 x 0.015. Pale red fabric; yellow *eng on surf*.

325 Base *fr. Bd* 0.1, *ext ht* 0.058. Brick-red fabric; *WR*.

326 Base *fr. Bd* 0.15, *ext ht* 0.06. Brick-red fabric; ochre *eng on out surf*; *WR*.

327 Base *fr. Bd* ?, *ext ht* 0.013.

328 Base *fr. Bd* 0.06, *ext ht* 0.016. Dark orange/red fabric.

SITE 24 (MOZOROTI BABA TEPA)

- 329 Rim fr. *Rd* 0.34, *ext ht* 0.124.
- 330 Rim fr. *Rd* 0.4, *ext ht* 0.077. Ochre eng on both surf.
- 331 Rim fr. *Rd* 0.07, *ext ht* 0.029. Inclusion size up to 0.001; WR.
- 332 Rim fr. *Rd* 0.1, *ext ht* 0.02. RS on both surf.
- 333 Rim fr. *Rd* 0.08, *ext ht* 0.054. RS; WR.
- 334 Rim fr. *Rd* 0.22, *ext ht* 0.067. Ochre eng and *rsd* of RS on both surf; WR.
- 335 Rim fr. *Rd* 0.25, *ext ht* 0.091. Ochre eng on both surf; WR.
- 336 Rim fr. *Rd* 0.38, *ext ht* 0.049. Ochre eng on both surf.
- 337 Rim fr. *Rd* 0.34, *ext ht* 0.107. For fabric description see [336].
- 338 Rim fr. *Rd* 0.04, *ext ht* 0.04. RS on both surf.
- 339 Rim fr. *Rd* 0.06, *ext ht* 0.019. For fabric description see [338].
- 340 Rim fr. *Rd* 0.12, *ext ht* 0.017. For fabric description see [338].
- 341 Rim fr. *Rd* 0.12, *ext ht* 0.019. For fabric description see [338].
- 342 Rim fr. *Rd* 0.17, *ext ht* 0.036. Ochre eng on both surf.
- 343 Rim fr. *Rd* 0.16, *ext ht* 0.036. RS on *in surf*.
- 344 Rim fr. *Rd* 0.34, *ext ht* 0.054. Sandwich fabric: red margins, black core; red/brown surf; supposedly HM.
- 345 Rim fr. *Rd* 0.2, *ext ht* 0.022.
- 346 Rim fr. *Rd* ?, *ext ht* 0.057. Grey fabric, *out surf* red; red and black *sl* stripe on *in surf*; inclusion size up to 0.005.
- 347 Rim fr. *Rd* ?, *ext ht* 0.057. Brick-red fabric; WR.
- 348 Body fr. *Pht* 0.038.
- 349 *Hdl fr. Pht* 0.101, *w* 0.023 x 0.023.
- 350 *Hdl fr. Pht* 0.066, *w* 0.023 x 0.011.
- 351 *Hdl fr. Pht* 0.028, *w* 0.031 x 0.01.
- 352 *Hdl fr. Pht* 0.038, *w* 0.03 x 0.015. RS.
- 353 *Hdl fr. Pht* 0.026, *w* 0.016 x 0.008. RS.
- 354 Knob fr. *Max th* 0.046. Brick-red fabric, ochre surf.
- 355 Base fr. *Bd* 0.062, *ext ht* 0.012. Spiral WR on *in surf*.
- 356 Base fr. *Bd* 0.13, *ext ht* 0.035.
- 357 Base fr. *Bd* 0.07, *ext ht* 0.03. Brick-red fabric.
- 358 Base fr. *Bd* 0.15, *ext ht* 0.034.

SITE 25 (TALAGANTEPA)

- 359 Rim *fr.* *Rd* ?, *ext ht* 0.016. Ochre fabric; black *sl* on *surf*.
- 360 Rim *fr.* *Rd* ?, *ext ht* 0.014. Ochre fabric; inclusion size up to 0.003.
- 361 Rim *fr.* *Rd* ?, *ext ht* 0.016. RS on both *surf*.
- 362 Rim *fr.* *Rd* ?, *ext ht* 0.014. For fabric description see [361].
- 363 Rim *fr.* *Rd* ?, *ext ht* 0.025. For fabric description see [361].
- 364 Rim *fr.* *Rd* ?, *ext ht* 0.024. For fabric description see [361].
- 365 Rim *fr.* *Rd* 0.19, *ext ht* 0.059. Brick-red fabric; red *eng* on *out surf*.
- 366 Rim *fr.* *Rd* 0.22, *ext ht* 0.031. Burn on *in* side; RS.
- 367 Rim *fr.* *Rd* 0.17, *ext ht* 0.018. Brown fabric; ochre *eng* on *surf*.
- 368 Rim *fr.* *Rd* 0.13, *ext ht* 0.03.
- 369 Rim *fr.* *Rd* 0.16, *ext ht* 0.03. Brown fabric; ochre *eng* on *out surf*.
- 370 Rim *fr.* *Rd* 0.12, *ext ht* 0.054. Orange fabric; ochre *eng* and *rsd* of RS on *out surf*.
- 371 Rim *fr.* *Rd* 0.4, *ext ht* 0.063. Orange fabric; red stains on fracture.
- 372 Rim *fr.* *Rd* 0.36, *ext ht* 0.067. Red fabric.
- 373 Rim *fr.* *Rd* 0.42, *ext ht* 0.074. Brick-red fabric; yellow *eng* on *surf*; RS in upper part.
- 374 Rim *fr.* *Rd* 0.11, *ext ht* 0.03. Orange fabric; *out surf* ochre; *rsd* of RS on *in surf*.
- 375 Rim *fr.* *Rd* 0.12, *ext ht* 0.031. Ochre fabric; *rsd* of RS.
- 376 Rim *fr.* *Rd* 0.11, *ext ht* 0.036. Brown fabric; black *sl* on *out surf*; RS on *in surf*.
- 377 Rim *fr.* *Rd* 0.09, *ext ht* 0.046. Grey/black fabric; *out surf* red.
- 378 Rim *fr.* *Rd* 0.07, *ext ht* 0.049. Orange fabric, *in surf* yellow; *rsd* of RS on *surf*; ochre *eng* on *out surf*.
- 379 Rim *fr.* *Rd* 0.28, *ext ht* 0.137. Brick-red fabric; yellow *eng* on *out surf*; inclusion size up to 0.005.
- 380 Rim *fr.* *Rd* 0.19, *ext ht* 0.017. Pink/red fabric; yellow *eng* on *surf*; unsure orientation.
- 381 Body *fr.* *Pht* 0.063. Pink fabric; yellow *eng* on *out surf*.
- 382 Body *fr.* *Pht* 0.034. Brick-red fabric, *out surf* brown, *in surf* ochre.
- 383 Body *fr.* *Pht* 0.036. Brick-red fabric; *rsd* of RS; yellow *eng* on *out surf*.
- 384 Body *fr.* *Pht* 0.027. Brown fabric, *in surf* ochre; yellow *eng* on *out surf*.
- 385 Body *fr.* *Pht* 0.025. RS on *out surf*.

SITE 26 (YALANGOYOQ OTA TEPA)

- 386 Rim *fr.* *Rd* 0.34, *ext ht* 0.072. Brick-red fabric; ochre *eng* and *rsd* of *RS* on *out surf*; *WR*.
- 387 Rim *fr.* *Rd* 0.35, *ext ht* 0.062. Brick-red fabric, *out surf* ochre.
- 388 Rim *fr.* *Rd* 0.1, *ext ht* 0.019. Brick-red fabric, ochre *eng* on both *surf*.
- 389 Rim *fr.* *Rd* 0.1, *ext ht* 0.03. Ochre *eng* on *out surf*.
- 390 Rim *fr.* *Rd* 0.11, *ext ht* 0.026. Ochre *eng* on *in surf*.
- 391 Rim *fr.* *Rd* 0.08, *ext ht* 0.025. *RS* on both *surf*.
- 392 Rim *fr.* *Rd* 0.07, *ext ht* 0.028. Brick-red fabric; *rsd* of ochre *eng* on both *surf*.
- 393 Rim *fr.* *Rd* 0.08, *ext ht* 0.019. Very fine, beige/orange fabric.
- 394 Rim *fr.* *Rd* 0.1, *ext ht* 0.033. Ochre *eng* on *out surf*.
- 395 Rim *fr.* *Rd* 0.11, *ext ht* 0.022. Pale beige fabric; *WR* on *out surf*.
- 396 Rim *fr.* *Rd* 0.11, *ext ht* 0.017. Ochre *eng* on *out surf*.
- 397 Rim *fr.* *Rd* 0.11, *ext ht* 0.019. Ochre *eng* on both *surf*.
- 398 Rim *fr.* *Rd* 0.22, *ext ht* 0.038. Orange fabric; ochre and red stains on *surf*; *HM* attachments.
- 399 Rim *fr.* *Rd* 0.2, *ext ht* 0.04. Orange fabric, *out surf* beige.
- 400 Rim *fr.* *Rd* 0.09, *ext ht* 0.069.
- 401 Rim *fr.* *Rd* 0.24, *ext ht* 0.048. Pale beige fabric; partially burned; quartz inclusion size up to 0.001.
- 402 Rim *fr.* *Rd* 0.11, *ext ht* 0.031. *Rsd* of *RS* on *out surf*.
- 403 Rim *fr.* *Rd* 0.19, *ext ht* 0.019. Brick-red fabric; ochre *eng* on *out surf*.
- 404 Rim *fr.* *Rd* 0.11, *ext ht* 0.024. Brick-red fabric; *WR*.
- 405 Rim *fr.* *Rd* 0.16, *ext ht* 0.028. Brick-red fabric; *HM* attachments.
- 406 Rim *fr.* *Rd* 0.12, *ext ht* 0.023.
- 407 Rim *fr.* *Rd* 0.18, *ext ht* 0.024. Very fine, dark orange fabric.
- 408 Rim *fr.* *Rd* 0.15, *ext ht* 0.023. Ochre *eng* on *out surf*.
- 409 Rim *fr.* *Rd* ?, *ext ht* 0.024.
- 410 Rim *fr.* *Rd* ?, *ext ht* 0.028. *Rsd* of *RS* on *out surf*.
- 411 Rim *fr.* *Rd* 0.25, *ext ht* 0.039. Brick-red fabric; ochre *eng* on *out surf*.
- 412 Rim *fr.* *Rd* ?, *ext ht* 0.041. For fabric description see [411].
- 413 Rim *fr.* *Rd* 0.26, *ext ht* 0.035. Fine, yellow/orange fabric.
- 414 Rim *fr.* *Rd* ?, *ext ht* 0.024. Fine, pale brown fabric, *out surf* beige/grey.

415 Rim *fr.* *Rd* 0.29, *ext ht* 0.032. Brick-red fabric; ochre *eng* on *surf*.

416 Rim *fr.* *Rd* 0.16, *ext ht* 0.039. Brick-red fabric; yellow stains.

417 Rim *fr.* *Rd* 0.11, *ext ht* 0.044. Ochre fabric, *in surf* brick-red; *WR*.

418 Rim *fr.* *Rd* 0.16, *ext ht* 0.029. Fine, dark red fabric.

419 Rim *fr.* *Rd* 0.15, *ext ht* 0.03. Pale orange fabric; ochre *eng* on both *surf*.

420 Rim *fr.* *Rd* 0.16, *ext ht* 0.038. Orange fabric; *out surf* yellow.

421 Rim *fr.* *Rd* 0.17, *ext ht* 0.04.

422 Rim *fr.* *Rd* 0.16, *ext ht* 0.021. Orange fabric; ochre *eng* on *out surf*.

423 Rim *fr.* *Rd* ?, *ext ht* 0.06. Brick-red fabric; ochre *eng* on *out surf*.

424 Rim *fr.* *Rd* ?, *ext ht* 0.062. Coarse, yellow/brown fabric.

425 Body *fr.* *Pht* 0.026. Brick-red fabric; ochre *eng* on *out surf*.

426 Knob *fr* (?). *Max th* 0.017. For fabric description see [425].

427 *Hdl fr.* *W* 0.035 x 0.011. Brick-red fabric, ochre *surf*.

428 Base *fr.* *Bd* 0.09, *ext ht* 0.014. *RS* on *in surf*.

429 Base *fr.* *Bd* ?, *ext ht* 0.033. Dark red fabric, partially orange.

430 Base *fr.* *Bd* 0.08, *ext ht* 0.023.

431 Base *fr.* *Bd* 0.06, *ext ht* 0.027. Brick-red fabric; ochre *eng* on *out surf*.

432 Base *fr.* *Bd* 0.055, *ext ht* 0.039. Brick-red fabric; *RS* on *out surf*.

433 Base *fr.* *Bd* 0.05, *ext ht* 0.031.

434 Base *fr.* *Bd* 0.06, *ext ht* 0.032.

SITE 27 (BABATEPA)

435 Rim *fr.* *Rd* 0.14, *ext ht* 0.054. *RS*.

436 Rim *fr.* *Rd* 0.11, *ext ht* 0.027. Brick-red fabric.

437 Rim *fr.* *Rd* 0.22, *ext ht* 0.043. Sandwich fabric: red margins, brown core; dark red/black *surf*.

438 Rim *fr.* *Rd* 0.23, *ext ht* 0.048. Brick-red fabric; ochre *eng* on *pt* of *out surf*, inclusion size up to 0.002.

439 Rim *fr.* *Rd* 0.4, *ext ht* 0.084. Brick-red fabric; ochre *eng* on *surf*.

440 Rim *fr.* *Rd* 0.19, *ext ht* 0.047. Ochre fabric; two *pnt* red stripes; red stains.

441 Rim *fr.* *Rd* 0.17, *ext ht* 0.03.

442 Rim *fr.* *Rd* 0.17, *ext ht* 0.044. Brick-red fabric; ochre *eng* on *out surf*.

443 Body *fr.* *Pht* 0.037. *RS* on both *surf*; *burn*.

444 Base *fr. Bd* ?, *ext ht* 0.09. Brick-red fabric; grainy; inclusion size up to 0.003. ochre *eng* on *out surf*; white grainy base; *in surf*

SITE 32 (TALASHKANTEPA II)

- | | |
|--|--|
| 445 Rim <i>fr. Rd</i> 0.16, <i>ext ht</i> 0.036. | 463 Rim <i>fr. Rd</i> 0.14, <i>ext ht</i> 0.067. |
| 446 Rim <i>fr. Rd</i> 0.2, <i>ext ht</i> 0.037. | 464 Rim <i>fr. Rd</i> 0.22, <i>ext ht</i> 0.032. |
| 447 Rim <i>fr. Rd</i> 0.26, <i>ext ht</i> 0.041. | 465 Rim <i>fr. Rd</i> 0.18, <i>ext ht</i> 0.04. |
| 448 Rim <i>fr. Rd</i> 0.2, <i>ext ht</i> 0.064. | 466 Rim <i>fr. Rd</i> 0.1, <i>ext ht</i> 0.051. |
| 449 Rim <i>fr. Rd</i> 0.16, <i>ext ht</i> 0.039. | 467 Rim <i>fr. Rd</i> 0.12, <i>ext ht</i> 0.05. |
| 450 Rim <i>fr. Rd</i> 0.38, <i>ext ht</i> 0.067. | 468 Rim <i>fr. Rd</i> 0.4, <i>ext ht</i> 0.092. |
| 451 Rim <i>fr. Rd</i> 0.4, <i>ext ht</i> 0.042. | 469 Rim <i>fr. Rd</i> 0.46, <i>ext ht</i> 0.055. |
| 452 Rim <i>fr. Rd</i> 0.12, <i>ext ht</i> 0.037. | 470 Rim <i>fr. Rd</i> 0.2, <i>ext ht</i> 0.082. |
| 453 Rim <i>fr. Rd</i> 0.11, <i>ext ht</i> 0.042. | 471 Rim <i>fr. Rd</i> 0.12, <i>ext ht</i> 0.044. |
| 454 Rim <i>fr. Rd</i> 0.1, <i>ext ht</i> 0.043. | 472 Rim <i>fr. Rd</i> 0.11, <i>ext ht</i> 0.042. |
| 455 Rim <i>fr. Rd</i> 0.48, <i>ext ht</i> 0.052. | 473 Body <i>fr. Pht</i> 0.038. |
| 456 Rim <i>fr. Rd</i> 0.08, <i>ext ht</i> 0.038. | 474 Body <i>fr. D</i> at upper fracture 0.14, <i>pht</i> 0.061. |
| 457 Rim <i>fr. Rd</i> 0.2, <i>ext ht</i> 0.045. | 475 Base <i>fr. Bd</i> 0.06, <i>ext ht</i> 0.047. |
| 458 Rim <i>fr. Rd</i> 0.18, <i>ext ht</i> 0.095. | 476 Base <i>fr. Bd</i> 0.055, <i>ext ht</i> 0.025. |
| 459 Rim <i>fr. Rd</i> 0.03, <i>ext ht</i> 0.052. | 477 Base <i>fr. Bd</i> 0.04, <i>ext ht</i> 0.029. Used secondary after breakage. |
| 460 Rim <i>fr. Rd</i> 0.24, <i>ext ht</i> 0.103. | 478 Base <i>fr. Bd</i> 0.045, <i>ext ht</i> 0.009. |
| 461 Rim <i>fr. Rd</i> 0.3, <i>ext ht</i> 0.11. | |
| 462 Rim <i>fr. Rd</i> 0.12, <i>ext ht</i> 0.024. | |

SITE 33

- | | |
|--|---|
| 479 <i>Comp vsl. Rd</i> 0.18, <i>bd</i> 0.12, <i>ht</i> 0.187. | 483 Rim <i>fr. Rd</i> 0.13, <i>ext ht</i> 0.034. Brick-red fabric; RS on both <i>surf</i> ; WR. |
| 480 <i>Compl vsl. Rd</i> 0.03, <i>bd</i> 0.07, <i>ht</i> 0.24. | 484 Rim <i>fr. Rd</i> 0.13, <i>ext ht</i> 0.03. Creamy brown fabric; <i>in surf</i> ochre. |
| 481 Rim <i>fr. Rd</i> 0.23, <i>ext ht</i> 0.046. Ochre <i>eng</i> on <i>surf</i> . | 485 Rim <i>fr. Rd</i> 0.06, <i>ext ht</i> 0.089. |
| 482 Rim <i>fr. Rd</i> 0.13, <i>ext ht</i> 0.041. WR. | |

486 Rim and *hdl fr.* *Rd* 0.16, *ext ht* 0.066.
Adherent *hdl* attachment.

487 Rim *fr.* *Rd* 0.28, *ext ht* 0.043. Corrupted;
probably adherent.

488 Rim *fr.* *Rd* 0.35, *ext ht* 0.06. Pale brown
fabric, ochre *eng* on *surf*; *WR*.

489 Rim *fr.* *Rd* 0.4, *ext ht* 0.078.

490 Rim *fr.* *Rd* 0.4, *ext ht* 0.058.

491 Rim *fr.* *Rd* 0.4, *ext ht* 0.036.

492 Rim *fr.* *Rd* 0.33, *ext ht* 0.099.

493 Rim *fr.* *Rd* ?, *ext ht* 0.065. Coarse, brick-
red fabric, *out surf* red/black; inclusion size up
to 0.003; *HM*.

494 Body *fr.* *Pht* 0.043.

495 Body *fr.* *Pht* 0.04.

496 Body and *hdl fr.* *Pht* 0.087.

497 Lid (?) knob. *Max d* 0.044, *ext ht* 0.031.
Fine, beige clay, reddish on fracture.

498 Base *fr.* *Bd* 0.23, *ext ht* 0.09. *WR*.

499 Base *fr.* *Bd* 0.24, *ext ht* 0.017. Brick-red
fabric; *in surf* unpreserved.

500 Base *fr.* *Bd* 0.024, *ext ht* 0.079. *RS*; spiral
WR on *in surf*.

501 Base *fr.* *Bd* 0.035, *ext ht* 0.036. *RS*; stem
attached after jiggering.

502 Base *fr.* *Bd* 0.145, *ext ht* 0.13.

503 Base *fr.* *Bd* 0.048, *ext ht* 0.072. *WR*;
impressed conch at the bottom.

SITE 35 (CHOPAN ATA)

504 Rim *fr.* *In rd* (without moulding) 0.26,
ext ht 0.037.

505 Rim *fr.* *Rd* 0.17, *ext ht* 0.053.
Brown/orange fabric with inclusions;
depression 0.007 in *d*.

506 Rim *fr.* *Rd* 0.12, *ext ht* 0.04. Orange
fabric, yellowish orange *surf*; shallow cuts on
surf.

507 Rim *fr.* *Rd* 0.24, *ext ht* 0.049. Orange
fabric, ochre/yellow *surf*; *inc crvl dec* on *out*
surf.

508 Rim *fr.* *Rd* 0.19, *ext ht* 0.027. Red/orange
fabric, ochre/yellow *surf*.

509 Rim *fr.* *Rd* 0.4, *ext ht* 0.063. Coarse,
orange/grey fabric with inclusions;
ochre/yellow *sl* on *out surf*.

SITE 35/36

510 Body *fr.* *Pht* 0.079. Pale orange/brown
fabric; perforated (*d* of perforation 0.008).

SITE 36(ANJIRTEPA)

511 Body *fr. Ph*t 0.05. Brick-red fabric; ochre *sl* and partially peeled-off *RS*; three tree-shaped impressions.

512 Body *fr. Ph*t 0.025. Brick-red fabric, dark brick-red *surf*.

513 Body *fr. Ph*t 0.05. Brick-red fabric; ochre *sl* on *out surf*.

SITE 37(AYRITEPA)

514 Rim *fr. Rd* ?, *ext ht* 0.033. Beige fabric, dark brown on fracture.

515 Rim *fr. Rd* ?, *ext ht* 0.021. Fine, dark red fabric, paler on *out surf*.

516 Rim *fr. Rd* ?, *ext ht* 0.027. Pale brown fabric; orange *sl*.

517 Rim *fr. Rd* 0.31, *ext ht* 0.067. Dark red fabric, yellow/brown on *out surf*.

518 Rim *fr. Rd* 0.25, *ext ht* 0.056. Reddish brown fabric, *out surf* beige.

519 Rim *fr. Rd* 0.15, *ext ht* 0.061. Coarse, dark brown fabric; burned on *out surf*.

520 Rim *fr. Rd* 0.19, *ext ht* 0.069. Beige fabric, orange on fracture.

521 Rim *fr. Rd* 0.1, *ext ht* 0.03. Orange fabric, pale brown on *out surf*.

522 Rim *fr. Rd* 0.11, *ext ht* 0.022. Pale orange fabric; *RS*.

523 Rim *fr. Rd* 0.12, *ext ht* 0.024. Very fine, pale brown fabric.

524 Rim *fr. Rd* 0.13, *ext ht* 0.019. Fine, pale beige fabric.

525 Rim *fr. Rd* 0.08, *ext ht* 0.027. Fine, pale brown fabric.

526 Rim *fr. Rd* 0.08, *ext ht* 0.024. For fabric description see [525].

527 Rim *fr. Rd* 0.06, *ext ht* 0.028. Reddish brown fabric.

528 Rim *fr. Rd* 0.05, *ext ht* 0.016. Dark brown fabric, *out surf* pinkish beige.

529 Rim *fr. Rd* 0.09, *ext ht* 0.02. Very fine, pale brown fabric; *RS*.

SITE 38

530 Rim *fr. Rd* 0.12, *ext ht* 0.022. Pale brown *out surf*; brown *in surf*.

SITE 40 (SHORTEPA)

- 531 Rim *fr. Rd* ?, *ext ht* 0.034. Orange fabric; ochre *eng* on *surf*.
- 532 Rim *fr. Rd* ?, *ext ht* 0.027. Orange fabric; RS on both *surf*.
- 533 Rim *fr. Rd* ?, *ext ht* 0.021. RS on both *surf*.
- 534 Rim *fr. Rd* ?, *ext ht* 0.031. Orange fabric, ochre on *surf*; unsure orientation.
- 535 Rim *fr. Rd* ?, *ext ht* 0.022. Orange fabric, *out surf* brick-red, *in surf* unpreserved; unsure orientation.
- 536 Rim *fr. Rd* ?, *ext ht* 0.018. Brown fabric; ochre *eng* on *out surf*.
- 537 Rim *fr. Rd* ?, *ext ht* 0.02. Brick-red fabric; *rsd* of ochre *eng*.
- 538 Rim *fr. Rd* ?, *ext ht* 0.012. Brick-red fabric; RS on both *surf*.
- 539 Rim *fr. Rd* 0.11, *ext ht* 0.04.
- 540 Rim *fr. Rd* 0.1, *ext ht* 0.035. Orange fabric; ochre *eng* on *surf*.
- 541 Rim *fr. Rd* 0.12, *ext ht* 0.019. Brick-red fabric, *in surf* orange.
- 542 Rim *fr. Rd* 0.05, *ext ht* 0.028. Brick-red fabric; ochre *eng* on *surf*.
- 543 Rim *fr. Rd* 0.05, *ext ht* 0.02. Brick-red fabric; RS on *in surf*.
- 544 Rim *fr. Rd* 0.3, *ext ht* 0.028. Brick-red fabric; orange *eng* on *surf*.
- 545 Rim *fr. Rd* 0.4, *ext ht* 0.075. Sandwich fabric: orange margins/brown core; *in surf* orange; ochre *eng* on *out surf*.
- 546 Rim *fr. Rd* 0.13, *ext ht* 0.027. Black fabric, *out surf* brick-red, *in surf* brown.
- 547 Rim *fr. Rd* 0.12, *ext ht* 0.027. Brick-red/orange fabric, *out surf* brick-red, *in surf* orange.
- 548 Rim *fr. Rd* 0.15, *ext ht* 0.035. RS on both *surf*.
- 549 Rim *fr. Rd* 0.11, *ext ht* 0.015. Brick-red fabric; ochre on *surf*.
- 550 Rim *fr. Rd* 0.14, *ext ht* 0.026. RS on both *surf*.
- 551 Rim *fr. Rd* 0.1, *ext ht* 0.036. Dark brown fabric.
- 552 Body *fr. Pht* 0.032. Orange fabric; ochre *eng* on *out surf*; WR.
- 553 *Hdl fr. W* 0.023 x 0.014. Brown fabric.
- 554 *Hdl fr. W* 0.015 x 0.013.
- 555 Base *fr. Bd* 0.12, *ext ht* 0.027.
- 556 Base *fr. Bd* 0.08, *ext ht* 0.027.

SITE 41

- 557 Rim *fr. Rd* ?, *ext ht* 0.047. Dark brown/red fabric.
- 558 Rim *fr. Rd* 0.34, *ext ht* 0.053. Orange/red fabric, *out surf* beige; plastic *lin dec* on *out surf*.

559 Rim *fr.* *Rd* 0.34, *ext ht* 0.058. Pale brown fabric, red on fracture; light blue *gl* on *in surf*.

560 Rim *fr.* *Rd* ?, *ext ht* 0.031. Coarse, dark red fabric, pale brown/beige on *surf*.

561 Rim *fr.* *Rd* 0.1, *ext ht* 0.024. Dark brown fabric, paler on *out surf*.

SITE 42 (AYSARITEPA)

562 Rim *fr.* *Rd* ?, *ext ht* 0.029. Black/red fabric, grey/white on *surf*; potsherd axially cut in halves.

563 Rim *fr.* *Rd* 0.05, *ext ht* 0.015. Greyish orange fabric.

564 Rim *fr.* *Rd* 0.1, *ext ht* 0.015. Porous greyish red fabric.

565 Rim *fr.* *Rd* 0.065, *ext ht* 0.024. Orange fabric; beige *sl*.

566 Rim *fr.* *Rd* 0.1, *ext ht* 0.036. Black/red fabric; large quartz inclusions; alternating black and red stripe *dec* on *in surf*.

567 Rim *fr.* *Rd* 0.12, *ext ht* 0.024. Orange fabric.

568 Rim *fr.* *Rd* 0.12, *ext ht* 0.023. Orange fabric; *out surf* white.

569 Rim *fr.* *Rd* 0.13, *ext ht* 0.03. Grey fabric.

570 Rim and *hdl fr.* *Rd* 0.11, *ext ht* 0.03. Dark red fabric, beige on *surf*.

571 Base *fr.* *Bd* 0.075, *ext ht* 0.01. Fine, dark grey fabric.

572 Base *fr.* *Bd* 0.09, *ext ht* 0.039. Coarse, grey fabric.

SITE 43

573 Rim *fr.* *Rd* 0.15, *ext ht* 0.029. Pale brown fabric, *out surf* yellow.

574 Rim *fr.* *Rd* 0.14, *ext ht* 0.028. Dark red fabric.

575 Rim *fr.* *Rd* 0.07, *ext ht* 0.044. Orange/red fabric, brown on *surf*.

576 Rim *fr.* *Rd* 0.1, *ext ht* 0.015. Orange/red fabric, *out surf* yellow/brown.

577 Rim *fr.* *Rd* 0.06, *ext ht* 0.026. Coarse, orange fabric.

578 Rim *fr.* *Rd* 0.085, *ext ht* 0.026. Fine, pale brown fabric, orange on fracture.

579 Rim *fr.* *Rd* 0.21, *ext ht* 0.027. Pale brown fabric, reddish on fracture.

580 Rim *fr.* *Rd* 0.24, *ext ht* 0.042. Orange/red fabric, brown on *surf*.

581 Rim *fr.* *Rd* 0.28, *ext ht* 0.036. Dark red fabric.

582 Rim *fr. Rd* 0.21, *ext ht* 0.048. Sandwich fabric: dark red/light brown margins, black core; quartz inclusion size up to 0.005.

583 Rim *fr. Rd* ?, *ext ht* 0.025. Orange/red fabric with inclusions.

584 Rim *fr. Rd* ?, *ext ht* 0.051. Coarse, brown fabric, greyish on *surf*; quartz inclusion size up to 0.006.

585 Base *fr. Bd* 0.06, *ext ht* 0.011. Dark brown fabric, *out surf* green/grey.

586 Base *fr. Bd* 0.04, *ext ht* 0.017. Red fabric; dark RS.

587 Base *fr. Bd* 0.08, *ext ht* 0.017. Very fine, black fabric.

SITE 45

588 Rim *fr. Rd* 0.17, *ext ht* 0.033. Brick-red fabric.

589 Rim *fr. Rd* 0.14, *ext ht* 0.029. RS on *in surf*.

590 Rim *fr. Rd* 0.11, *ext ht* 0.047.

591 Rim *fr. Rd* 0.18, *ext ht* 0.021. RS on both *surf*.

592 Rim *fr. Rd* 0.21, *ext ht* 0.023.

593 Rim *fr. Rd* 0.32, *ext ht* 0.019. Ochre *eng* on both *surf*.

594 Rim *fr. Rd* 0.4, *ext ht* 0.085.

595 Rim *fr. Rd* 0.2, *ext ht* 0.069. Brick-red fabric.

596 Rim *fr. Rd* 0.22, *ext ht* 0.032. Ochre *eng* on both *surf*.

597 Body *fr. Ph* 0.047. RS on *out surf*.

598 Body *fr. Ph* 0.06. Dark red fabric, *in surf* pale red; ochre *eng* on *out surf*.

599 *Hdl fr. W* 0.033 x 0.01. Brick-red fabric; ochre *eng* on *out surf*.

600 *Hdl fr. W* 0.017 x 0.011. Brick-red fabric.

SITE 48 (SOUTH-EAST MOUND OF KATTATEPA)

601 *Comp lid. Lid d* 0.09, *ht* 0.034. Fine, grey/beige fabric.

602 Rim *fr. Rd* ?, *ext ht* 0.012. Dark orange, green/beige on *surf*.

603 Rim *fr. Rd* 0.06, *ext ht* 0.02. Dark brown/red fabric.

604 Rim *fr. Rd* 0.08, *ext ht* 0.054. Orange/brown fabric with inclusions, grey/beige on *surf*; moulding on *surf*.

605 Rim *fr. Rd* 0.12, *ext ht* 0.013. Dark orange fabric; RS.

606 Rim *fr. Rd* 0.31, *ext ht* 0.074. Brown/orange fabric; *in surf* burned.

607 Base *fr. Bd* 0.142, *ext ht* 0.135. Beige fabric; orange stains.

SITE 49 (OLLEIORTEPA)

608 Rim *fr. Rd* ?, *ext ht* 0.017. Black, green and white *gl* (floral *dec*); *rsd* of *gl* on *out surf*.

SITE 50

609 Rim *fr. Rd* ?, *ext ht* 0.02. Orange fabric, creamy ochre on *surf*.

610 Body *fr. Pht (in)* 0.031. Orange fabric, *in surf* yellow; yellow *gl* on *out surf*; *WR*; unsure orientation.

611 Body *fr. Pht* 0.02. Orange fabric, *in surf* yellow; yellow *gl* on *out surf*; unsure orientation.

612 Base *fr. Bd* 0.08, *ext ht* 0.036. Orange fabric, creamy/yellow on *out surf*; distinctive *WR*.

SITE 52 (KHOSYATTEPA)

613 Rim *fr. Rd* ?, *ext ht* 0.019. Brick-red fabric; ochre *eng* and *rsd* of *RS* on *out surf*.

614 Rim *fr. Rd* ?, *ext ht* 0.015. For fabric description see [613].

615 Rim *fr. Rd* 0.11, *ext ht* 0.028. Brick-red fabric; inclusion size up to 0.002.

616 Body *fr. Pht* 0.018. Orange fabric; yellow *eng* on both *surf*.

SITE 53 (TIGRMANTEPA)

617 Rim *fr. Rd* 0.25, *ext ht* 0.027. Brick-red fabric.

618 Base *fr. Bd* ?, *ext ht* 0.047. Brown fabric; ochre *eng* on *surf*.

SITE 54 (ANJIRTEPA)

619 Body *fr. Pht* 0.04. Brick-red fabric; *RS* on out surf.

620 Base *fr. Bd* 0.08, *ext ht* 0.062.

621 Base *fr. Bd* 0.09, *ext ht* 0.02. Brick-red fabric.

SITE 55 (KHALINCHAKTEPA)

622 Rim *fr. Rd* 0.38, *ext ht* 0.079. Brown fabric; ochre *eng* on surf.

623 Rim and *hdl fr. Rd* 0.09, *ext ht* 0.03. Ochre fabric; ochre *eng* on surf.

624 Rim *fr. Rd* 0.17, *ext ht* 0.042.

625 Rim *fr. Rd* 0.1, *ext ht* 0.015. Brick-red fabric; ochre *eng* on out surf.

626 Rim *fr. Rd* ?, *ext ht* 0.033. For fabric description see [625].

627 Body *fr. Pht* 0.056. Orange fabric; white, black and partially blue *gl* and *inc dec* on in surf; stripe of white *gl* on out surf; unsure orientation.

628 Body *fr. Pht* 0.031. Orange fabric; ochre *eng* on surf.

629 *Hld fr. W* 0.035 x 0.018.

630 Base *fr. Bd* 0.05, *ext ht* 0.011. Brick-red fabric.

SITE 56 (MAYDANKURGAN)

631 *Comp vsl. Rd* 0.12, *ht* 0.045. Brick-red fabric; white/yellow *eng* on surf; *HM*.

632 Rim *fr. Rd* 0.12, *ext ht* 0.049. Brown fabric; brown *eng* on out surf; inclusion size up to 0.003.

633 Rim and *hdl fr. Rd* 0.06, *ext ht* 0.022. Brick-red fabric; yellow *eng* on surf.

634 Rim *fr. Rd* 0.14, *ext ht* 0.025. Brown/yellow fabric; *RS* on surf.

635 Rim *fr. Rd* 0.4, *ext ht* 0.072. Sandwich fabric: red margins, black core, in surf brick-

red; ochre *eng* on out surf; inclusion size up to 0.007.

636 Rim *fr. Rd* ?, *ext ht* 0.046. Brick-red fabric; ochre *eng* on surf.

637 Body *fr. Pht* 0.113. Black/grey fabric, out surf brick-red; unsure orientation.

638 Body *fr. Pht* 0.06. Brick-red fabric, pale red surf.

639 *Hdl fr. W* 0.035 x 0.012. Brick-red fabric; yellow *eng* on surf.

640 *Hdl fr. W* 0.046 x 0.015. Pink fabric; yellow *eng* on surf.

641 Base *fr.* *Bd* 0.12, *ext ht* 0.038. Orange fabric; light yellow *eng* on *surf*.

642 Base *fr.* *Bd* 0.1, *ext ht* 0.036. Brick-red fabric; yellow *eng* on *out surf*; *WR*.

643 Base *fr.* *Bd* 0.14, *ext ht* 0.03. Brick-red fabric; ochre *eng* on *out surf*.

SITE 57 (KHUSHVAKTTEPA)

644 Rim *fr.* *Rd* 0.32, *ext ht* 0.071. Grey fabric; inclusion size up to 0.005.

645 Rim *fr.* *Rd* 0.19, *ext ht* 0.055. *RS. PreD* 3rd-4th c. AD, *cf.* Zavyalov 2008, 169: 82.9.

646 Body and *hdl fr.* Body *ht* 0.105. Ochre/brown fabric; ochre *eng* on *surf*.

647 Body *fr.* *Ph* 0.07. Yellow fabric; *RS*; *WR*.

648 Base *fr.* *Bd* 0.12, *ext ht* 0.037. Orange fabric; ochre *eng* on *out surf*; *WR*.

649 Base *fr.* *Bd* 0.1, *ext ht* 0.022. Ochre fabric, *out surf* black and ochre; inclusion size up to 0.005.

650 Base *fr.* *Bd* 0.18, *ext ht* 0.018. Orange fabric; red/orange *eng* on *out surf*; *in surf* unpreserved.

SITE 58 (ANJIRTEPA)

651 Rim *fr.* *Rd* 0.1, *ext ht* 0.029. Brown fabric; ochre *eng* on *surf*; *HM*.

652 Rim *fr.* *Rd* 0.1, *ext ht* 0.017. Brick-red fabric; ochre *eng* on *out surf*.

653 Rim *fr.* *Rd* 0.14, *ext ht* 0.043. Brown fabric; ochre *eng* on *out surf*; *rsd* of *RS* on *in surf*.

654 Rim *fr.* *Rd* ?, *ext ht* 0.023.

655 Rim *fr.* *Rd* ?, *ext ht* 0.019. Brown fabric; ochre *eng* on *surf*.

656 Body *fr.* *Ph* 0.018. Unsure orientation.

657 *Hdl fr.* *W* 0.025 x 0.011. Brick-red fabric.

SITE 61

658 Rim *fr.* *Rd* 0.24, *ext ht* 0.079. Brick-red fabric; ochre *eng* on *surf*.

659 Rim *fr.* *Rd* ?, *ext ht* 0.094. Sandwich fabric: red margins/black core; ochre *eng* on *surf*.

660 Rim *fr.* *Rd* ?, *ext ht* 0.052. Brown fabric.

661 Body *fr.* *Pht* 0.04. Orange fabric, *out surf* ochre, *in surf* unpreserved, unsure orientation.

SITE 62

662 Body *fr.* *Pht* 0.045.

663 Base *fr.* *Bd* 0.11, *ext ht* 0.06. Ochre fabric; yellow/white *sl* on *surf*.

SITE 63 (CHALAKURGAN)

664 Rim *fr.* *Rd* 0.24, *ext ht* 0.046. Black fabric, red on *surf*.

665 Rim *fr.* *Rd* 0.15, *ext ht* 0.018. Brown fabric; ochre *eng* on *surf*.

666 Rim *fr.* *Rd* ?, *ext ht* 0.047. Brick-red fabric; ochre *eng* on *surf*.

667 Rim *fr.* *Rd* ?, *ext ht* 0.034. Brown fabric; ochre *eng* on *out surf*; *in surf* unpreserved.

668 Rim *fr.* *Rd* ?, *ext ht* 0.027. *RS* on both *surf*.

669 Rim *fr.* *Rd* ?, *ext ht* 0.014. Brick-red/orange fabric, *in surf* orange, *out surf* brick-red.

670 Rim *fr.* *Rd* ?, *ext ht* 0.015. Brown fabric, *out surf* ochre, *in surf* orange; fine *gl*.

671 Body *fr.* *Pht* 0.028. Brick-red fabric; ochre *eng* on *out surf*.

672 Body *fr.* *Pht* 0.032. Brick-red fabric; *RS* on *out surf*.

673 Body *fr.* *Pht* 0.012. Yellow fabric.

SITE 71

674 Rim *fr.* *Rd* 0.37, *ext ht* 0.055. Dark orange/reddish fabric, *out surf* beige.

SITE 72 (NORTH-WEST MOUND OF TALASHKANTEPA)

675 Rim *fr.* *Rd* 0.38, *ext ht* 0.042. Orange fabric; *out surf* partially beige.

676 Rim *fr.* *Rd* 0.16, *ext ht* 0.034. Fine, pale brown fabric; *RS*.

677 Rim *fr.* *Rd* 0.08, *ext ht* 0.013. Orange fabric, yellow/brown on *surf*.

678 Rim *fr.* *Rd* 0.07, *ext ht* 0.046. Fine, grey fabric, black on *in surf*; *inc dec* on *out surf*.

679 Rim and *hdl fr.* *Rd* 0.08, *ext ht* 0.08. Dark red fabric; *WR*.

680 Rim *fr.* *Rd* ?, *ext ht* 0.029. Brown fabric; *inc dec*.

681 Body *fr.* *Pht* 0.192. Beige fabric; partially red stains on *surf*.

682 Base *fr.* *Bd* 0.108, *ext ht* 0.013. Coarse, dark red fabric.

SITE 75

683 Rim *fr.* *Rd* 0.26, *ext ht* 0.088.

684 Rim *fr.* *Rd* 0.18, *ext ht* 0.032.

685 Rim *fr.* *Rd* 0.2, *ext ht* 0.018.

686 Rim *fr.* *Rd* 0.2, *ext ht* 0.016.

687 Body and *hdl fr.* *Pht* 0.066.

688 Body *fr.* *Pht* 0.047.

689 Base *fr.* *Bd* 0.06, *ext ht* 0.025.

SITE 77 (EGIZTEPA I)

690 Rim *fr.* *Rd* 0.18, *ext ht* 0.025. Dark red fabric.

691 Rim *fr.* *Rd* 0.12, *ext ht* 0.038. Reddish brown fabric.

692 Rim *fr.* *Rd* ?, *ext ht* 0.023. Dark red fabric; greyish *RS*.

693 Base *fr.* *Bd* 0.04, *ext ht* 0.015. For fabric description see [692].

SITE 78 (EGIZTEPA II)

694 Rim *fr.* *Rd* ?, *ext ht* 0.03. Dark brown/red fabric.

695 Rim *fr.* *Rd* 0.34, *ext ht* 0.038. For fabric description see [694].

696 Rim *fr.* *Rd* 0.2, *ext ht* 0.031. Dark brown fabric, *in surf* reddish.

697 Rim *fr.* *Rd* 0.12, *ext ht* 0.026. Very fine, dark red fabric; finely *pol*.

698 Rim *fr.* *Rd* 0.09, *ext ht* 0.016. Very fine, dark red fabric, *in surf* brownish.

699 Base *fr.* *Bd* 0.05, *ext ht* 0.015. Dark brown, partially reddish fabric; tiny quartz inclusions.

SITE 79

- 700 *Comp vsl. Rd* 0.42, *ht* 0.08.
701 *Rim fr. Rd* 0.13, *ext ht* 0.068.
702 *Body and hdl fr. Body pht* 0.039.
703 *Body fr. Pht* 0.041.
704 *Base fr. Bd* 0.1, *ext ht* 0.087.
705 *Base fr. Bd* 0.09, *ext ht* 0.066.

SITE 80

- 706 *Rim fr. Rd* 0.3, *ext ht* 0.05. Dark orange fabric.
707 *Rim fr. Rd* 0.36, *ext ht* 0.032. Pale orange fabric, *surf* beige.
708 *Rim fr. Rd* 0.28, *ext ht* 0.015.
709 *Rim and hdl fr. Rd* 0.09, *ext ht* 0.047.
710 *Rim fr. Rd* 0.12, *ext ht* 0.025. Black fabric with inclusions, *surf* red.
711 *Rim fr. Rd* 0.13, *ext ht* 0.018.
712 *Rim fr. Rd* 0.26, *ext ht* 0.057. Orange fabric; beige *sl*.
713 *Rim fr. Rd* 0.14, *ext ht* 0.053. Dark orange fabric, *surf* ochre; brown inclusions of considerable size; burned; *HM*.
714 *Rim fr. Rd* 0.12, *ext ht* 0.03.
715 *Rim fr. Rd* 0.1, *ext ht* 0.026.
716 *Rim fr. Rd* 0.06, *ext ht* 0.04. Dark orange fabric; grey *sl* on *out surf*.
717 *Rim fr. Rd* 0.08, *ext ht* 0.026.
718 *Rim fr. Rd* 0.07, *ext ht* 0.019.
719 *Rim fr. Rd* 0.07, *ext ht* 0.03.
720 *Rim fr. Rd* ?, *ext ht* 0.028. *HM*.
721 *Rim fr. Rd* ?, *ext ht* 0.024.
722 *Rim fr. Rd* ?, *ext ht* 0.037. Green/blue *gl*.
723 *Lid fr. Rd* 0.16, *ext ht* 0.015.
724 *Body fr. Pht* 0.039.
725 *Body (?) /rim (?) fr. Ht* 0.022.
726 *Base fr. Bd* 0.09, *ext ht* 0.018. Beige fabric; crackled green *gl* on *in surf*.
727 *Base fr. Bd* 0.16, *ext ht* 0.035. Orange fabric; beige *sl* on *out surf*.
728 *Base fr. Bd* 0.1, *ext ht* 0.037. Orange fabric, *surf* beige.

SITE 88

- 729 *Rim fr. Rd* 0.41, *ext ht* 0.078. Fine orange/red fabric, *out surf* pale yellow/brown; *inc dec* on *in rim*.
730 *Rim and hdl fr. Rd* ?, *ext ht* 0.104, *hdl w* 0.035 x 0.015. Very fine, pale yellow/brown fabric; *inc lin dec* on *out surf*.

731 Rim *fr.* *Rd* 0.27, *ext ht* 0.068. Brown fabric, yellow/brown on *surf*; *inc* geometric *dec* on *out surf*.

732 Rim *fr.* *Rd* 0.23, *ext ht* 0.046. Fine, pale yellow/brown fabric, red on fracture; *inc dec*.

733 Rim *fr.* *Rd* 0.014, *ext ht* 0.103. Grey/black fabric.

734 Rim *fr.* *Rd* ?, *ext ht* 0.04. Fine, pale yellow/brown fabric, darker on fracture; *inc dec* on *in surf*.

735 Rim *fr.* *Rd* 0.17, *ext ht* 0.029. Red fabric, *surf* pale yellow/brown.

736 Rim *fr.* *Rd* 0.13(?), *ext ht* 0.016. Fine, orange fabric..

737 *Hdl fr.* *W* 0.037 x 0.017. Fine, pale yellow/brown fabric.

738 Base *fr.* *Bd* 0.07, *ext ht* 0.023. Very fine, orange/brown fabric.

SITE 90 (KHONTEPA)

739 Rim and *hdl fr.* *Rd* 0.08, *ext ht* 0.075.

740 Rim *fr.* *Rd* 0.10, *ext ht* 0.021.

741 Rim *fr.* *Rd* 0.18, *ext ht* 0.018.

742 Rim *fr.* *Rd* 0.11, *ext ht* 0.024.

743 Base *fr.* *Bd* 0.2, *ext ht* 0.027.

744 Base *fr.* *Bd* 0.26, *ext ht* 0.074.

SITE 94 (KURGAN)

745 Rim and *hdl fr.* *Rd* 0.08, *ext ht* 0.051, *w* 0.058 x 0.028. Pale orange fabric.

746 Rim *fr.* *Rd* ?, *ext ht* 0.045. Fine, red fabric, *surf* brown/yellow; *inc cvrl dec*.

747 Rim *fr.* *Rd* ?, *ext ht* 0.05. Coarse fabric, brown/yellow on *out surf*, orange on *in surf*.

748 Rim *fr.* *Rd* ?, *ext ht* 0.03. Very fine, pale brown fabric; green, blue and black *gl* on *in surf*; cyan *gl* on *out surf*.

749 Rim *fr.* *Rd* 0.36, *ext ht* 0.057. Fine, pale brown/yellow/red fabric.

750 Rim *fr.* *Rd* 0.23, *ext ht* 0.06. Coarse, reddish fabric, *in surf* black.

751 Rim *fr.* *Rd* 0.2, *ext ht* 0.041. Fine, pale orange fabric, *in surf* darker.

752 Rim *fr.* *Rd* 0.44, *ext ht* 0.037. Very fine, pale yellow/brown fabric, orange on fracture; *inc dec* on rim.

753 Rim *fr.* *Rd* 0.2-0.24, *ext ht* 0.035. Grey fabric; blue, green and black *gl*.

754 Rim *fr.* *Rd* 0.15, *ext ht* 0.02. Fine, pale brown/yellow fabric, orange on fracture.

755 Rim *fr.* *Rd* 0.13, *ext ht* 0.02. Fine, brown/yellow fabric; white *gl* on *out surf*; green/blue *gl* on *in surf*.

756 Rim *fr.* *Rd* 0.13, *ext ht* 0.018. Coarse, yellow/orange fabric.

757 Rim *fr.* *Rd* 0.045, *ext ht* 0.016. Fine, red fabric, *surf* brown/yellow.

758 Rim *fr.* *Rd* 0.05, *ext ht* 0.03. Coarse, orange/brown fabric.

759 Rim *fr.* *Rd* 0.08, *ext ht* 0.023. Fine, pale yellow/brown fabric.

760 Rim *fr.* *Rd* 0.07, *ext ht* 0.028. Pale yellow/brown fabric; brown *sl.*

761 Spout *fr.* *L* 0.063, spout *d* at the knob 0.022. Coarse, pale brown fabric.

762 Base *fr.* *Bd* 0.12, *ext ht* 0.011. Fine, pale brown fabric; green purple and white *gl.*

763 Base *fr.* *Bd* 0.05, *ext ht* 0.016. Pale brown fabric; green and blue *gl.*

764 Base *fr.* *Bd* 0.045, *ext ht* 0.009. Fine, brown/yellow fabric; dark *RS.*

765 Base *fr.* *Bd* 0.07, *ext ht* 0.064. Fine, beige fabric; cyan and black *gl* on upper part.

SITE 95

766 *Comp vsl.* *Rd* 0.27, *bd* 0.08, *ht* 0.084. Very fine, pale yellow/brown fabric; *WR.*

767 Rim *fr.* *Rd* 0.16, *ext ht* 0.025. Very fine, pale red fabric.

768 Rim *fr.* *Rd* 0.18, *ext ht* 0.019. Fine, pale yellow/brown fabric, black and blue *gl.*

769 Rim *fr.* *Rd* 0.12, *ext ht* 0.024. Coarse, brick-red fabric.

770 Rim *fr.* *Rd* 0.19, *ext ht* 0.04. Fine, pale brown fabric.

771 Rim *fr.* *Rd* 0.07, *ext ht* 0.026. Very fine, pale orange fabric; *rsd* of brown *sl* on *in surf.*

772 Rim *fr.* *Rd* 0.1, *ext ht* 0.026. Fine, orange fabric; orange *sl.*

773 Rim *fr.* *Rd* 0.1, *ext ht* 0.029. Fine, pale brown fabric; *hdl* broken away.

774 Rim *fr.* *Rd* 0.11, *ext ht* 0.033. Fine, orange/brown fabric; *rsd* of *RS.*

775 Rim *fr.* *Rd* 0.12, *ext ht* 0.035. Fine, dark red fabric, *out surf* coarse, brown/grey.

776 Rim *fr.* *Rd* 0.24, *ext ht* 0.042. Very fine, pale orange fabric, *surf* brown/yellow.

777 Rim *fr.* *Rd* 0.28, *ext ht* 0.027. Fine, pale grey fabric; brown and green *gl* on *in surf.*

778 Rim *fr.* *Rd* 0.25, *ext ht* 0.056. Very fine, pale yellow/brown fabric, orange on fracture.

779 Rim *fr.* *Rd* 0.34, *ext ht* 0.064. Fine, pale brown fabric; blue *gl* (floral and geometric *dec.*).

780 Rim *fr.* *Rd* 0.34, *ext ht* 0.045. Fine, orange fabric.

781 Rim *fr.* *Rd* 0.35, *ext ht* 0.0243. Fine, pale yellow/brown fabric, pinkish on *surf*; *inc lin dec* on *out rim.*

782 Rim *fr.* *Rd* 0.35, *ext ht* 0.065. Fine, pale yellow/brown fabric, pinkish on fracture; *inc crvl dec* on *out rim*; *WR.*

783 Rim *fr.* *Rd* 0.36, *ext ht* 0.05. Fine, pale yellow/brown fabric, pinkish on fracture; *inc crvl dec* on *out rim*.

784 Rim *fr.* *Rd* 0.38, *ext ht* 0.075. Fine, pale yellow/brown fabric; distinctive *WR*.

785 Rim *fr.* *Rd* 0.38, *ext ht* 0.055. Grey fabric, *out surf* orange; quartz inclusion size up to 0.004.

786 Rim *fr.* *Rd* 0.26, *ext ht* 0.058. Coarse fabric, dark red on *surf*; *in surf* burned; white inclusion size up to 0.005.

787 Rim *fr.* *Rd* 0.18, *ext ht* 0.055. Black fabric, dark red on *surf*; inclusion size up to 0.003.

788 Base *fr.* *Bd* 0.11, *ext ht* 0.04. Coarse, pale orange fabric; white and black *gl* (floral and solar motives).

789 Base *fr.* *Bd* 0.1, *ext ht* 0.073. Fine, pale brown fabric; white and blue *gl* on *in surf*; cuts and ledges – probably defects in manufacture.

SITE 96

790 Rim *fr.* *Rd* 0.25(?), *ext ht* 0.053. Coarse pale brown fabric, dark red on fracture.

791 *Hdl fr.* *Pht* 0.04, *w* 0.023 x 0.013.

SITE 98 (HURJOK CEMETERY)

792 Rim *fr.* *Rd* 0.415, *ext ht* 0.17. Fine, beige fabric, orange on fracture.

793 Rim *fr.* *Rd* 0.37, *ext ht* 0.088. Fine, orange fabric, white on *out surf*; plastic *dec* on rim.

794 Rim *fr.* *Rd* 0.32, *ext ht* 0.064. Coarse, orange fabric with grey core; quartz inclusions.

795 Rim *fr.* *Rd* 0.24, *ext ht* 0.033. Coarse, dark brown fabric with quartz inclusions; white/pinkish *sl*.

796 Rim *fr.* *Rd* 0.28, *ext ht* 0.028. Pale beige fabric; orange, brown and green *gl* on *in surf*.

797 Rim *fr.* *Rd* 0.13, *ext ht* 0.016. Fine, brown/orange fabric; orange *sl*.

798 Rim and *hdl fr.* *Rd* ?, rim *ht* 0.046. Coarse, grey/brown fabric; quartz and smashed ceramics inclusions (approximately 0.002); twisted *hdl*.

799 Body and *hdl fr.* *Pht* 0.158. Very fine, pale brown fabric, *out surf* white, sporadically red stains; *inc dec* on *out surf*.

800 Body *fr.* *Pht* 0.097. Fine, pale brown/yellow fabric; compound floral motives stamped (details badly preserved); traces of impressed fingers.

801 Base *fr.* *Bd* 0.08, *ext ht* 0.021. Beige fabric; cyan, black and white *gl* on *in surf* (floral motive).

802 Base *fr.* *Bd* 0.06, *ext ht* 0.035. Pale beige fabric; light blue *gl* on *in surf*; vertical *lin dec* on *out surf*; *HM*.

803 Base *fr.* *Bd* 0.055, *ext ht* 0.032. Very fine, pale brown fabric, darker on *surf*.

804 Base *fr.* *Bd* 0.04, *ext ht* 0.015. Pale brown fabric; white *gl* on *in surf*.

805 Base *fr.* *Bd* 0.1, *ext ht* 0.026. Fine, pale beige fabric, orange on fracture; green, yellow and black *gl* on *in surf* (geometric motive).

806 Base *fr.* *Bd* 0.1, *ext ht* 0.049. Fine, orange/beige fabric; *in surf* badly preserved; bossed.

807 Base (?) *fr.* *Bd* 0.11, *ext ht* 0.058. Beige fabric, *out surf* pale yellow/brown; unsure orientation.

SITE 98 (TALASHKANTEPA III)

808 Rim *fr.* *Rd* 0.45, *ext ht* 0.052.

809 Rim *fr.* *Rd* 0.45, *ext ht* 0.046.

810 Rim *fr.* *Rd* 0.42, *ext ht* 0.087. Beige fabric, *in surf* orange.

811 Rim *fr.* *Rd* 0.34, *ext ht* 0.05.

812 Rim *fr.* *Rd* 0.29, *ext ht* 0.096.

813 Rim *fr.* *Rd* 0.34, *ext ht* 0.085.

814 Rim *fr.* *Rd* ?, *ext ht* 0.085

815 Rim *fr.* *Rd* ?, *ext ht* 0.087.

816 Rim *fr.* *Rd* 0.14, *ext ht* 0.044.

817 Rim and *hdl fr.* *Rd* ?, *ext ht* 0.046, *hdl w* 0.029 x 0.012.

818 Rim *fr.* *Rd* ?, *ext ht* 0.039.

819 Rim *fr.* *Rd* ?, *ext ht* 0.035.

820 Rim *fr.* *Rd* ?, *ext ht* 0.036. White/yellow fabric. Plastic *dec*.

821 Rim (?) *fr.* *Rd* ?, *w* 0.044.

822 Body *fr.* *Pht* 0.063. *Inc* floral *dec*.

823 Body *fr.* *Pht* 0.069. *Inc* floral *dec*.

824 Base *fr.* *Bd* 0.12, *ext ht* 0.033.

825 Base *fr.* *Bd* 0.12, *ext ht* 0.042.

826 Base *fr.* *Bd* ?, *ext ht* 0.017.

SITE 100

827 Rim *fr.* *Rd* 0.45, *ht* 0.122. Coarse, yellow/brown/orange fabric, brown on fracture.

828 Rim *fr.* *Rd* 0.38, *ext ht* 0.055. Pale brown fabric, darker on fracture.

829 Rim *fr.* *Rd* 0.17, *ext ht* 0.083. Orange fabric, *out surf* yellow/brown.

830 Rim and *hdl fr.* *Rd* 0.19, *ext ht* 0.056, *w* 0.033 x 0.011. Fine, brown fabric; *inc dec* on *out surf*.

831 Rim and *hdl fr.* *Rd* 0.05, *ext ht* 0.03, *w* 0.031 x 0.022. Grey/brown fabric with brown inclusions.

832 Rim *fr.* *Rd* 0.08, *ext ht* 0.022. Pale brown fabric; cyan, blue and green *gl (lin dec)*.

833 Rim *fr.* *Rd* 0.19, *ext ht* 0.05. Yellow/brown fabric, red on fracture; *dec* rim.

834 Rim and *hdl fr.* *Rd* 0.11, *ext rim ht* 0.031. Orange/brown fabric, *out surf* yellow/brown; rivet-imitating *hdl*.

835 Rim *fr.* *Rd* 0.11, *ext ht* 0.037. Fine, orange/brown fabric.

836 Rim *fr.* *Rd* 0.42, *ext ht* 0.154. Dark grey/brown fabric.

837 Knob. Max *d* 0.066, *ht* 0.034. Very coarse, brown fabric.

838 Body *fr.* Max *d* 0.046, *pht* 0.047. Pale brown fabric.

839 Base *fr.* *Bd* 0.06, *ext ht* 0.046. Pale brown/orange fabric; white and blue *gl (dots)* on *in surf*.

840 Base *fr.* *Bd* 0.07, *ext ht* 0.047. Orange fabric; light brown *sl*.

841 Base *fr.* *Bd* 0.065, *ext ht* 0.051. Brown/orange fabric.

SITE 101

842 Rim *fr.* *Rd* 0.17, *ext ht* 0.073. Orange fabric; beige *sl*.

843 Rim *fr.* *Rd* 0.18, *ext ht* 0.04. Worn, beige *sl*.

844 Rim *fr.* *Rd* 0.18, *ext ht* 0.049. Orange fabric; beige *sl*.

845 Rim *fr.* *Rd* 0.14, *ext ht* 0.057. *Out surf* beige, *in surf* orange.

846 Rim *fr.* *Rd* 0.055, *ext ht* 0.036.

847 Rim *fr.* *Rd* ?, *ext ht* 0.027. Orange fabric; *out surf* beige.

848 Base *fr.* *Bd* 0.05, *ext ht* 0.02.

849 Base *fr.* *Bd* 0.075, *ext ht* 0.048. Grey/orange fabric, *surf* beige.

SITE 103

850 Rim *fr.* *Rd* 0.34, *ext ht* 0.054. Orange fabric; *surf* beige.

851 Lid *fr.* *Rd* 0.18, *ext ht* 0.022.

852 Vsl *fr. D* 0.07, *p ht* 0.137. Orange fabric; *surf* beige.

853 Base *fr. Bd* 0.11, *ext ht* 0.082. Pale orange fabric, *surf* beige.

854 Base *fr. Bd* 0.08, *ext ht* 0.028. Pale orange fabric; green and white *gl* on *in surf*.

855 Base *fr. Bd* 0.11, *ext ht* 0.049. Pale orange fabric.

856 Base *fr. Bd* 0.36, *ext ht* 0.043. Orange fabric, *in surf* white; peeled-off *surf*.

SITE 105 (within the cemetery of OLD AKKURQON VILLAGE)

857 Rim *fr. Rd* 0.04, *ext ht* 0.015. Yellow/brown fabric, beige on fracture.

858 Rim *fr. Rd* ?, *ext ht* 0.019. Beige fabric, *out surf* yellow/brown.

859 Rim *fr. Rd* ?, *ext ht* 0.03. Beige fabric.

860 Base *fr. Bd* 0.11, *ext ht* 0.07. Orange/pink fabric; orange *sl*.

SITE 107 (ZINDONTEPA)

861 Rim *fr. Rd* 0.31, *ext ht* 0.03. Very pale brown fabric.

862 Rim *fr. Rd* 0.19, *ext ht* 0.035. Pale brown fabric; quartz inclusions.

863 Base *fr. Bd* 0.15, *ext ht* 0.077. Coarse, beige fabric.

864 Base *fr. Bd* 0.09, *ext ht* 0.017. Beige fabric.

865 Base *fr. Bd* 0.1, *ext ht* 0.025. Beige fabric.

866 Base *fr. Bd* ?, *ext ht* 0.054. Pale brown/pinkish fabric; badly preserved.

SITE 108 (KULALTEPA - BURIAL GROUND NORTH)

867 Base *fr. Bd* 0.12, *ext ht* 0.026. Beige fabric, orange on *surf*.

SITE 109 (KULALTEPA)

868 Rim *fr.* *Rd* 0.31, *ext ht* 0.049. Coarse, grey fabric, *out surf* orange; quartz inclusion size up to 0.005.

869 Rim *fr.* *Rd* 0.39, *ext ht* 0.086. Grey, partially orange fabric; quartz inclusion size up to 0.006.

870 Rim *fr.* *Rd* 0.1, *ext ht* 0.019. Fine, pale orange fabric; *RS*.

871 Rim *fr.* *Rd* 0.07, *ext ht* 0.043. Fine, pale orange fabric; *RS*; *inc crvl dec* on *out surf*.

872 Rim *fr.* *Rd* 0.07, *ext ht* 0.015. Very fine, pale brown fabric; *RS*.

873 Rim *fr.* *Rd* 0.07, *ext ht* 0.026. Fine, beige fabric, greyish on fracture.

874 Rim *fr.* *Rd* 0.14, *ext ht* 0.027. Fine, beige fabric, reddish on fracture; *RS*.

875 Rim *fr.* *Rd* 0.16, *ext ht* 0.04. Coarse, pale orange fabric.

876 Rim *fr.* *Rd* 0.18, *ext ht* 0.032. Coarse, orange fabric; white *sl* (?).

877 Rim *fr.* *Rd* ?, *ext ht* 0.071. Dark red fabric, *out surf* beige.

878 Base *fr.* *Bd* 0.04, *ext ht* 0.022. Fine, orange/beige fabric; traces of *WR* on *in surf*.

879 Base *fr.* *Bd* 0.13, *ext ht* 0.037. Pale beige/orange fabric; rough *in surf*.

880 Base *fr.* *Bd* 0.13, *ext ht* 0.026. Orange fabric; *RS*.

SITE 110 (ABDUL MAJAM SAID CEMETERY)

881 Rim *fr.* *Rd* ?, *ext ht* 0.032. Smooth, lustrous, pale beige/brown *surf*.

882 Rim *fr.* *Rd* ?, *ext ht* 0.023. Orange/brown fabric; white *lin dec* on *out surf*.

883 Rim *fr.* *Rd* 0.17, *ext ht* 0.012. Coarse, orange/red fabric, *out surf* white; quartz inclusion size up to 0.004.

884 Rim *fr.* *Rd* 0.3, *ext ht* 0.055. Very coarse, beige fabric; numerous brown and black inclusion size up to 0.005, moulding under *out lip*.

SITE 112 (SOBIR ARCHA)

885 Rim *fr.* *Rd* ?, *ext ht* 0.033. Very fine, orange fabric, *surf* yellow; rim deformed by incision.

886 Rim and *hdl fr.* *Rd* 0.06, *ext rim ht* 0.027, *hdl w* 0.044 x 0.016. Fine, pale beige fabric.

887 Rim *fr.* *Rd* 0.08, *ext ht* 0.017. Very fine, pale brown fabric.

888 Base *fr.* *Bd* 0.05, *ext ht* 0.019. Fine, pale brown/pink fabric; white *sl* on *out surf*.

889 Base *fr.* *Bd* 0.1, *ext ht* 0.013. Fine, orange fabric.

890 Base *fr.* *Bd* ?, *ext ht* 0.033. Coarse, yellow/brown fabric, beige on fracture.

SITE 113 (AMIRKONDI)

891 Rim *fr.* *Rd* ?, *ext ht* 0.021. Very fine, orange/yellow fabric.

892 Rim *fr.* *Rd* ?, *ext ht* 0.037. Coarse, red fabric; brown and black inclusion size up to 0.003.

893 Base *fr.* *Bd* 0.08, *ext ht* 0.061. Pale orange fabric; *out surf* white.

SITE 116 (KURGANTEPA)

894 Base(?) *fr.* *D* 0.031 and 0.025 respectively, *ext ht* 0.06.

895 Base *fr.* *Bd* 0.26, *ext ht* 0.025.

SITE 117 (HOTAMTOY)

896 Body *fr.* *Pht* 0.04.

897 Body *fr.* *Pht* 0.045.

SITE 119

898 Rim *fr.* *Rd* 0.21, *ext ht* 0.031. Pale brown fabric, *surf* yellow.

899 Rim *fr.* *Rd* 0.2, *ext ht* 0.033. Pale beige fabric, orange on fracture; *inc crvl dec* on *out lip*.

900 Rim *fr.* *Rd* 0.25, *ext ht* 0.018. White/yellow fabric, orange on fracture.

901 Rim *fr.* *Rd* 0.3, *ext ht* 0.019. Orange fabric; RS (?).

SITE 120

902 Rim *fr.* *Rd* 0.37, *ext ht* 0.044. Beige fabric, orange/brown on fracture.

903 Rim *fr.* *Rd* 0.08, *ext ht* 0.019. Grey/brown fabric, red/brownish on fracture.

904 Rim *fr.* *Rd* 0.09, *ext ht* 0.07. White/yellow fabric, beige on fracture.

905 Rim *fr.* *Rd* 0.1, *ext ht* 0.055. Pale orange fabric, *out surf* white; plastic *dec* on lip.

906 Rim *fr.* *Rd* 0.1, *ext ht* 0.05. Beige fabric, *surf* white; plastic *dec* on lip.

907 Base *fr.* *Bd* 0.075, *ext ht* 0.04. Beige fabric; blue and black *gl* (*lin dec*).

908 Base *fr.* *Bd* 0.1, *ext ht* 0.025. Beige fabric; white, black and green/blue *gl*.

SITE 124

909 Rim *fr.* *Rd* 0.3, *ext ht* 0.028. Fine, dark fabric, polychromatic *gl*.

910 Rim *fr.* *Rd* 0.21, *ext ht* 0.026. Coarse, dark brown fabric, dark grey on fracture; ceramic (?) inclusions.

SITE 125 (KHOJAI GAMBIR-OTA TEPA)

911 Rim *fr.* *Rd* ?, *ext ht* 0.02. Yellow/grey fabric.

912 Rim *fr.* *Rd* ?, *ext ht* 0.031.

913 Rim *fr.* *Rd* 0.2, *ext ht* 0.04. Orange fabric, *surf* yellow.

914 Rim *fr.* *Rd* 0.09, *ext ht* 0.035. Pale orange fabric, *out surf* yellow.

915 Rim *fr.* *Rd* 0.16, *ext ht* 0.039. For fabric description see [908].

916 Rim *fr.* *Rd* 0.12, *ext ht* 0.028. Fine, orange/yellow fabric.

917 Rim *fr.* *Rd* 0.38, *ext ht* 0.069. Very fine, orange fabric, *surf* yellow.

918 Base *fr.* *Bd* 0.08, *ext ht* 0.031. Fine, beige/brown fabric.

919 Base *fr.* *Bd* 0.14, *ext ht* 0.032. Orange/dark brown fabric; *inc lin dec* on *out surf*.

920 Base *fr.* *Bd* 0.06, *ext ht* 0.011. Pale orange/beige fabric.

SITE 127

921 Rim *fr. Rd* ?, *ext ht* 0.03. Pale brown fabric, light blue *gl*.

922 Rim *fr. Rd* ?, *ext ht* 0.03. Very coarse, orange/grey fabric.

SITE 128 (KISHLOK BAZAR KABRISTONI)

923 Rim *fr. Rd* ?, *ext ht* 0.03. Orange/brown fabric, *in surf* black and brown/white.

926 Base *fr. Bd* 0.06, *ext ht* 0.031. Coarse, dark red, partially beige fabric.

924 Rim *fr. Rd* 0.24, *ext ht* 0.024. Dark brown fabric; partially burned.

927 Base *fr. Bd* ?, *ext ht* 0.089. Coarse, grey/green fabric.

925 Base *fr. Bd* 0.11, *ext ht* 0.022. Yellow/orange fabric.

SITE 129 (CHUYANCHI OTA KABRISTONI)

928 *Comp vsl. Rd* 0.34, *bd* 0.25, *ht* 0.093. Pale brown fabric; *inc crvl dec on in lip*.

930 Rim *fr. Rd* ?, *ext ht* 0.015. Pale brown fabric; cyan *gl*.

929 Rim *fr. Rd* 0.4, *ext ht* 0.137. Fine, pale orange fabric.

931 Rim *fr. Rd* 0.18, *ext ht* 0.035. Grey/brown fabric.

SITE 131

932 Rim *fr. Rd* 0.28, *ext ht* 0.077.

935 Rim *fr. Rd* 0.12, *ext ht* 0.062.

933 Rim *fr. Rd* 0.28, *ext ht* 0.072.

936 Base *fr. Bd* 0.12, *ext ht* 0.022.

934 Rim *fr. Rd* 0.36, *ext ht* 0.042.

SITE 133 (IRJAHANGIR-OTA KABRISTONI)

937 Rim *fr. Rd* 0.26, *ext ht* 0.035.

939 Rim *fr. Rd* 0.32, *ext ht* 0.058.

938 Rim *fr. Rd* 0.3, *ext ht* 0.033.

940 Rim *fr. Rd* 0.12, *ext ht* 0.061.

941 Rim *fr. Rd* 0.09, *ext ht* 0.047.

943 Base *fr. Bd* 0.07, *ext ht* 0.034.

942 Rim *fr. Rd* 0.09, *ext ht* 0.048.

944 Base *fr. Bd* 0.07, *ext ht* 0.024.

SITE 134 (AKTOSH-BOBO KABRISTONI)

945 Rim *fr. Rd* 0.14, *ext ht* 0.021.

948 Body *fr. Ph* 0.037.

946 Rim *fr. Rd* 0.11, *ext ht* 0.054.

949 Body *fr. Ph* 0.044.

947 Body *fr. Ph* 0.038.

950 Base *fr. Bd* 0.11, *ext ht* 0.015.

SITE 135 (KHOJAKIYAMIDDIN-OTA KABRISTONI)

951 Body *fr. Ph* 0.057.

952 Base *fr. Bd* 0.11, *ext ht* 0.057.

SITE 136

953 Base *fr. Bd* 0.12, *ext ht* 0.012.

IN BETWEEN SITES 136 AND 137

954 Rim *fr. Rd* 0.33, *ext ht* 0.051.

SITE 138

955 Rim *fr. Rd* 0.28, *ext ht* 0.042.

SITE 139 (TOSHTEPA)

956 Rim *fr. Rd* 0.34, *ext ht* 0.041.

SITE 141

957 Rim *fr. Rd* 0.21, *ext ht* 0.025.

958 Body *fr. Ph* 0.056.

SITE 142

- 959 Rim *fr. Rd* ?, *ext ht* 0.018. 961 Base *fr. Bd* 0.08, *ext ht* 0.019.
960 Rim *fr. Rd* 0.2, *ext ht* 0.014. 962 Base *fr. Bd* 0.1, *ext ht* 0.056.

SITE 143

- 963 Rim *fr. Rd* 0.2, *ext ht* 0.043. 967 Rim *fr. Rd* 0.3, *ext ht* 0.034.
964 Rim *fr. Rd* 0.2, *ext ht* 0.043. 968 Body *fr. Pht* 0.048.
965 Rim *fr. Rd* 0.26, *ext ht* 0.019. 969 *Spt fr.* Ht 0.03, l 0.053.
966 Rim *fr. Rd* 0.28, *ext ht* 0.027. 970 Base *fr. Bd* 0.1, *ext ht* 0.014.

SITE 144

- 971 Rim *fr. Rd* 0.28, *ext ht* 0.02.

SITE 145

- 972 Rim *fr. Rd* 0.3, *ext ht* 0.034. 978 Body *fr. Pht* 0.053.
973 Body *fr. Pht* 0.068. 979 Body *fr. Pht* 0.05.
974 Body *fr. Pht* 0.075. 980 Body *fr. Pht* 0.04.
975 Body *fr. Pht* 0.056. 981 Body *fr. Pht* 0.033.
976 Body *fr. Pht* 0.028. 982 Body *fr. Pht* 0.051.
977 Body *fr. Pht* 0.048. 983 Base *fr. Bd* 0.13, *ext ht* 0.03.

SITE 146

- 984 Rim *fr. Rd* 0.31, *ext ht* 0.109. 987 Base *fr. Bd* 0.12, *ext ht* 0.032.
985 Rim *fr. Rd* 0.4, *ext ht* 0.032. 988 Base *fr. Bd* 0.12, *ext ht* 0.021.
986 Body *fr. Pht* 0.08.

SITE 149

989 Rim *fr.* *Rd* 0.24, *ext ht* 0.055.

990 Rim *fr.* *Rd* 0.26, *ext ht* 0.075.

SITE 157 (OTA-KUL' MULLA ISHAN BABA)

991 Body and *hdl fr.* *Ext ht* 0.116.

992 Base *fr.* *Bd* 0.13, *ext ht* 0.054.

SITE 161

993 Rim *fr.* *Rd* 0.22, *ext ht* 0.023.

999 Body *fr.* *Pht* 0.045. *Inc dec* (nine parallel lines).

994 Rim *fr.* *Rd* ?, *ext ht* 0.033. *HM*.

995 Rim *fr.* *Rd* ?, *ext ht* 0.027. Coarse fabric; *inc dec*; *HM*.

1000 *Hdl fr.* *Pht* 0.03, *w* 0.027 x 0.017. *Inc dec* (cut-in strokes), frequent inclusion size up to 0.003.

996 Body *fr.* *Pht* 0.041. Coarse fabric; *HM*.

997 Body *fr.* *Pht* 0.06. Burnished on *out surf*; *inc dec*, impressed wedges; *HM*.

1001 *Hdl fr.* *Pht* 0.041, *max w* 0.036 x 0.014.

998 Body *fr.* *Pht* 0.07. S-shaped attachment; inclusion size up to 0.003.

1002 Base *fr.* *Bd* 0.075, *ext ht* 0.027.

1003 Base *fr.* *Bd* 0.06, *ext ht* 0.025.

SITE 163

1004 Rim *fr.* *Rd* 0.37 (?), *ext ht* 0.044.

1005 Body *fr.* *Pht* 0.042. Engraved *vert* lines in two rows (probably on whole perimeter); moss on *surf*.

1006 *Hdl fr.* *W* 0.04 x 0.017.

SITE 165

1007 Body *fr.* *Pht* 0.031.

MISCELLANEA

Tokens

1008 Token. $D \pm 0.02$. Orange/brown fabric; beige *sl* on one *surf*. (Site 4)

1009 Token. $D \pm 0.023$. Orange fabric; yellowish *sl* on one *surf*. (Site 5)

1010 Token. $D \pm 0.033$. Pale brown fabric; smooth on *surf*. (Site 96)

1011 Token. $D \pm 0.026$. Brick orange fabric. (Site 26)

1012 Token. $D \pm 0.033$. Red/orange fabric, fracture: yellow core/red margins. (Site 40)

1013 Token. $D \pm 0.055$. Rough, brown fabric. (Site 72)

1014 Token. $D \pm 0.075$. Brick-red fabric; ochre *eng* on *out surf*. (Site 33)

Lamps

1015 TC lamp. *Bd* 0.036, *max ht* 0.03. Fine fabric. (Site 60)

1016 TC lamp. *Bd* 0.038, *pht* 0.026. Brown/orange fabric, *HM*. (Site 48)

Statuettes

1017 Zoomorphic statuette *fr.* *Max* dimensions 0.077x0.043x0.062. (Site 32)

1018 Statuette *fr.* *Max* dimensions 0.06 x 0.038 x 0.047. (Site 32)

1019 Zoomorphic statuette *fr.* *Max* dimensions 0.095 x 0.048 x 0.038. (Site 99)

1020 Zoomorphic statuette. *Max* dimensions 0.128 x 0.07 x 0.061. (Site 48)

1021 Anthropomorphic statuette *fr.* *Max* dimensions 0.046 x 0.036. (Site 61)

1022 Statuette *fr.* *Max* dimensions 0.042 x 0.023 x 0.013. Pale brown fabric. (Site 98)

1023 Statuette/appliqué *fr.* *Max* dimensions 0.05 x 0.015 x 0.014. Dark orange fabric, ochre/orange on *out surf*; dark stone and charcoal inclusions. (Site 5)

Beads

1024 Bead. D 0.02, *ht* 0.018. (Site 80)

1025 Bead. D 0.025, *ht* 0.015. (Site 11)

Supplementum IV

CATALOGUE
TABLES

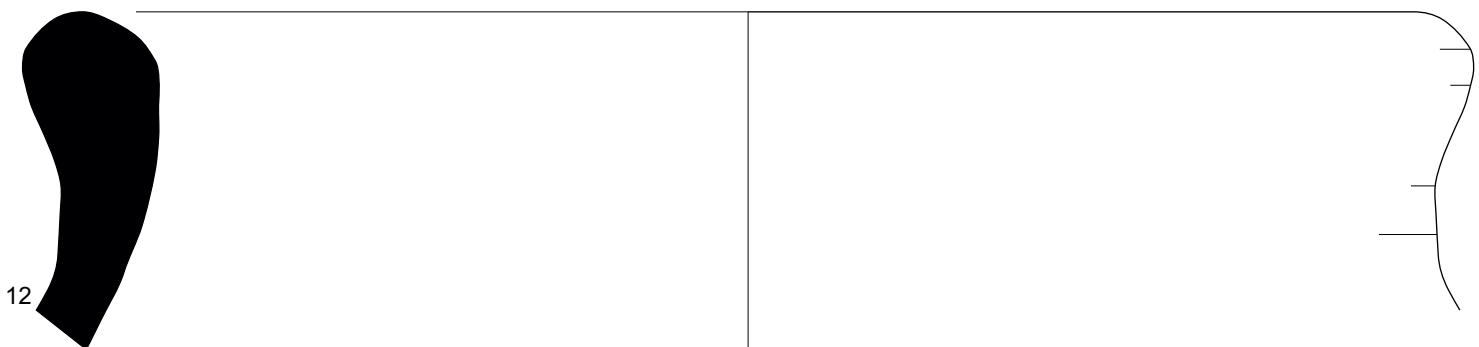
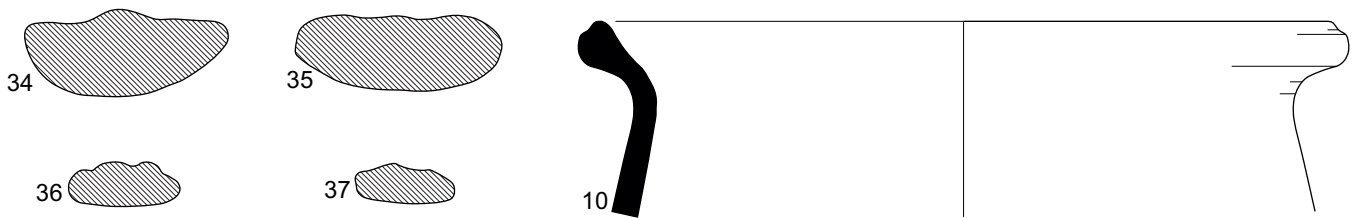
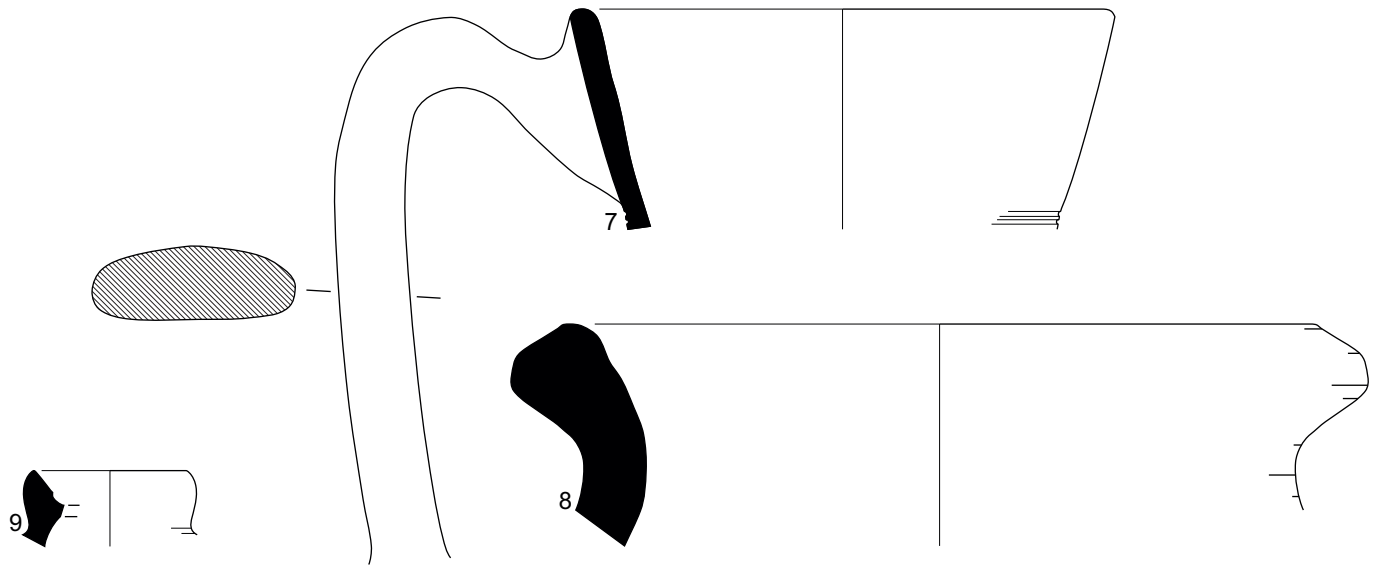
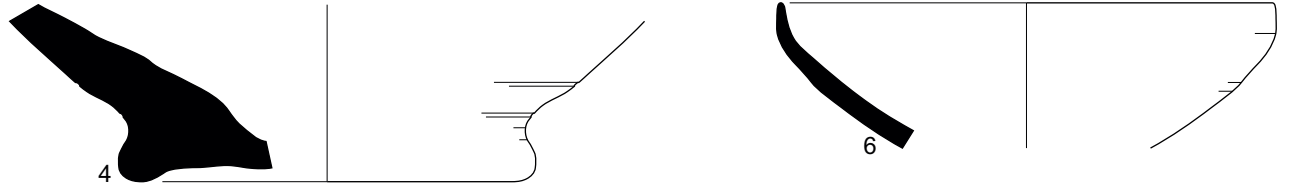
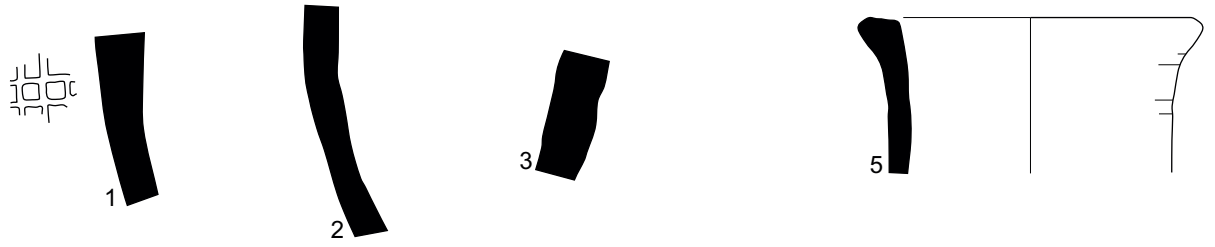

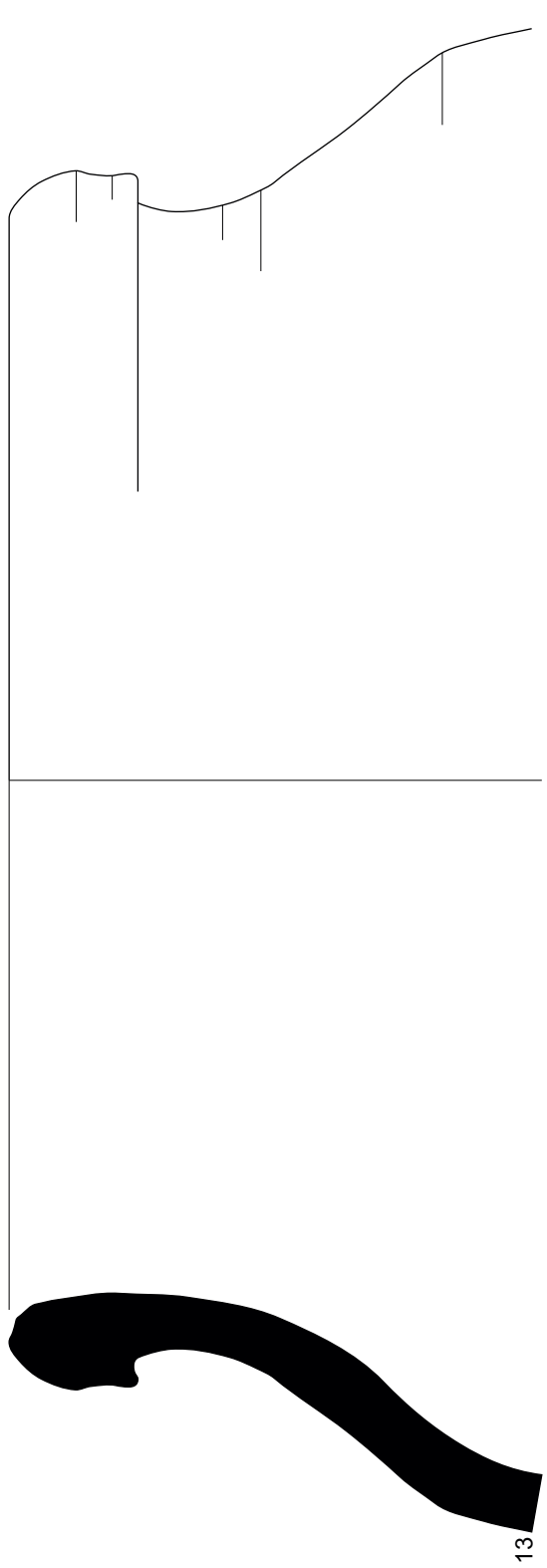

13

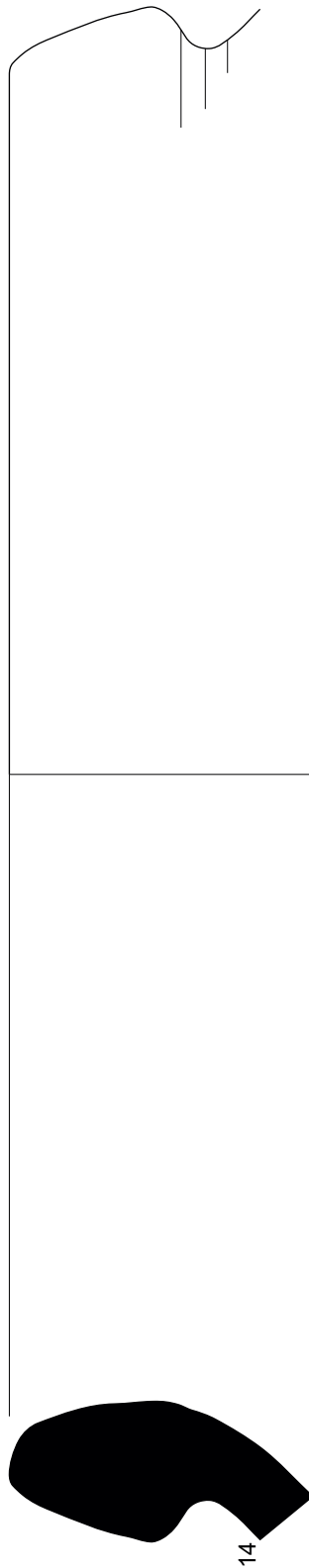

14

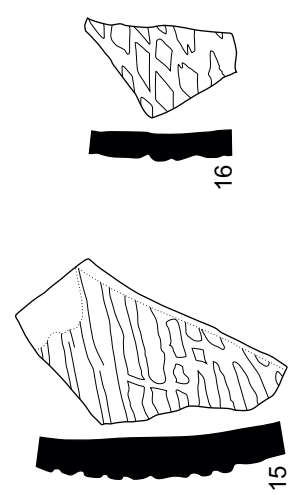

15

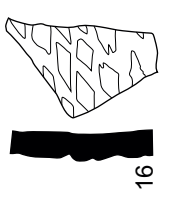

16

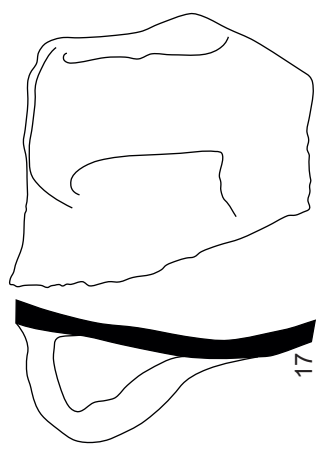

17

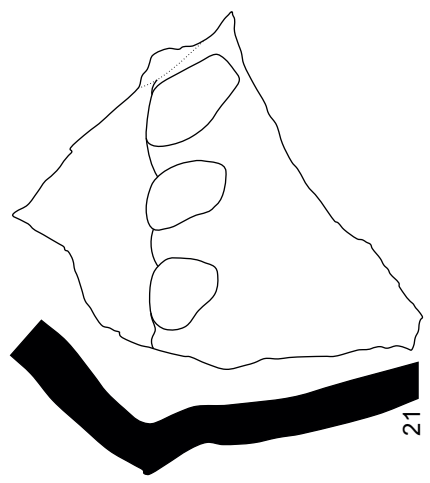

21

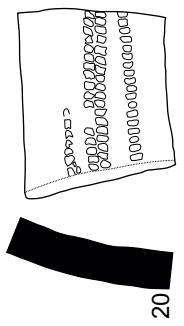

20

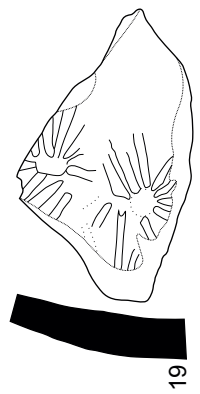

19

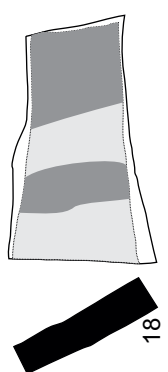

18



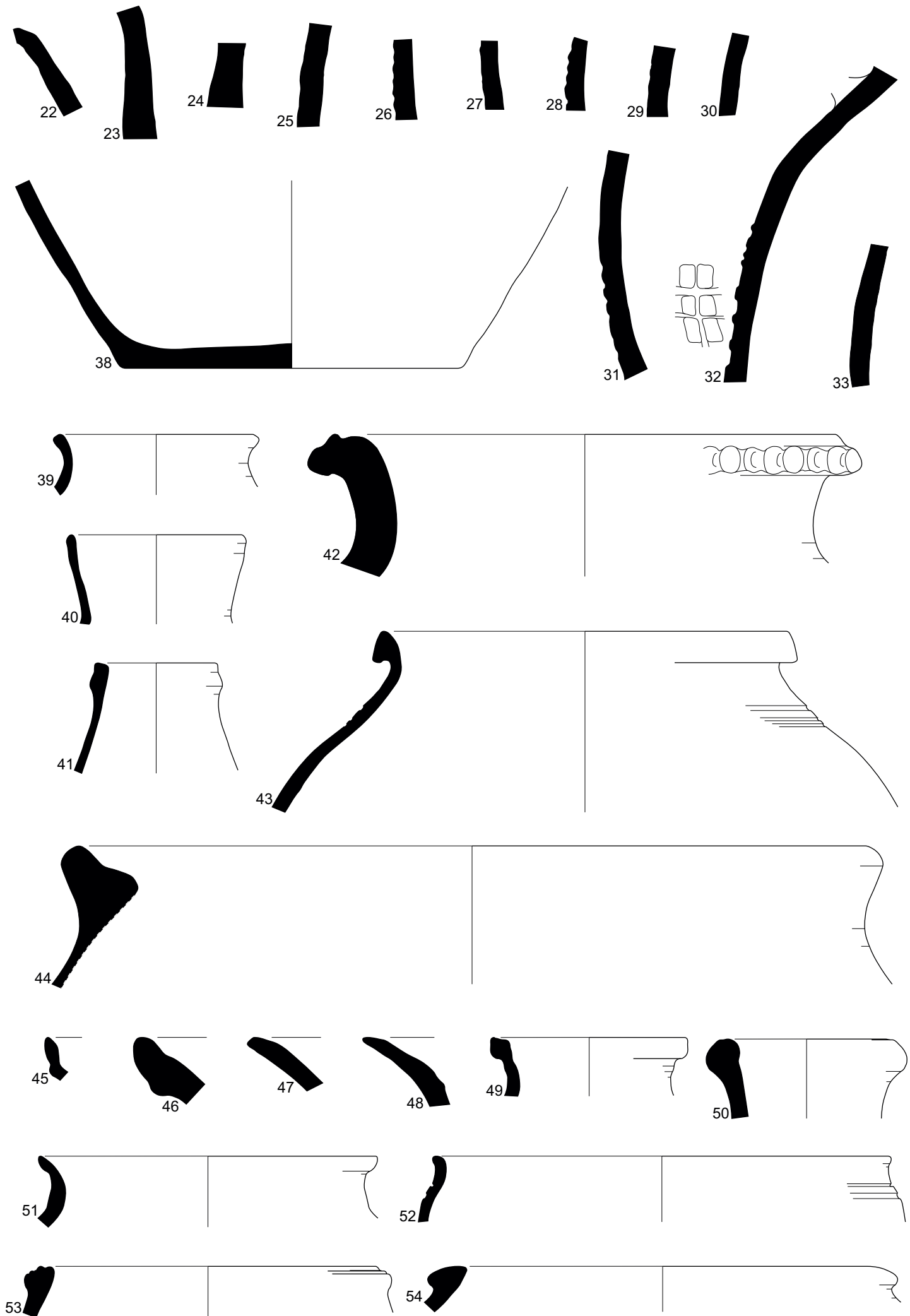

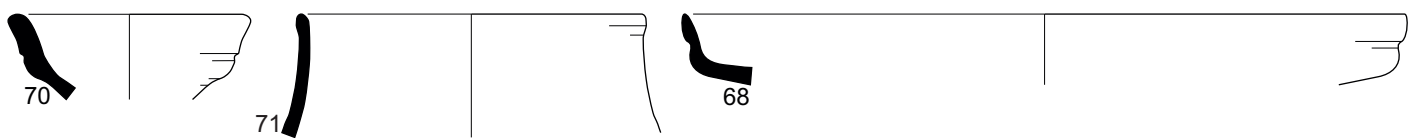
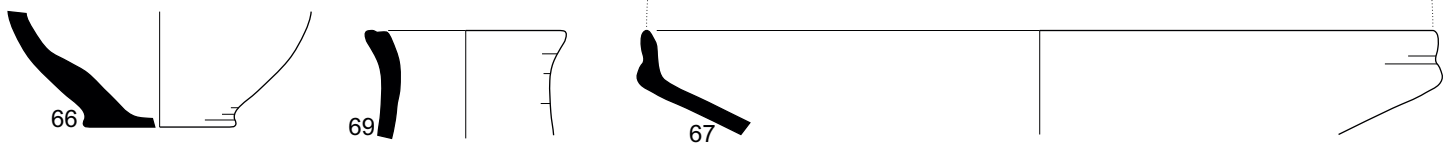
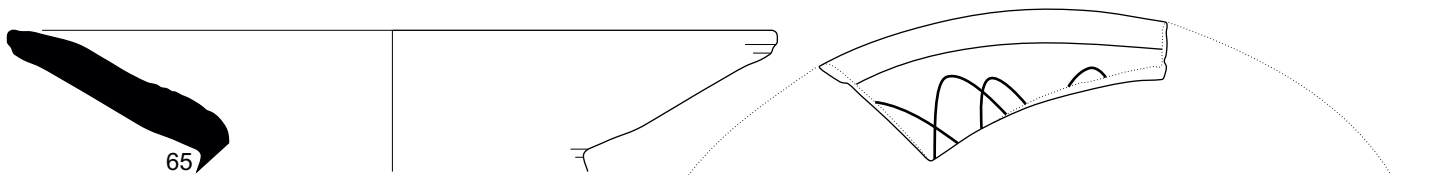
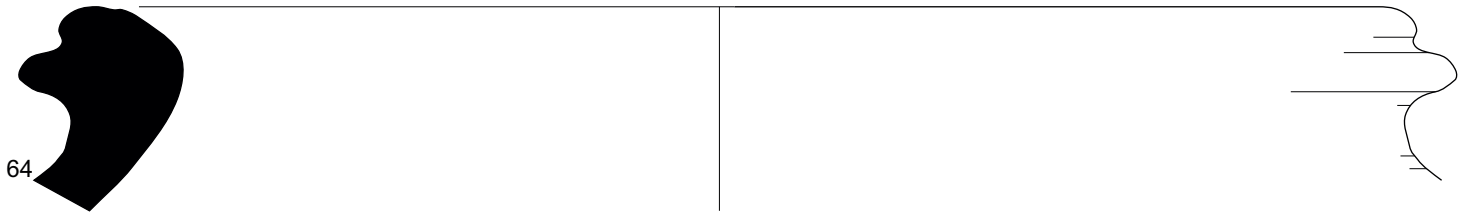
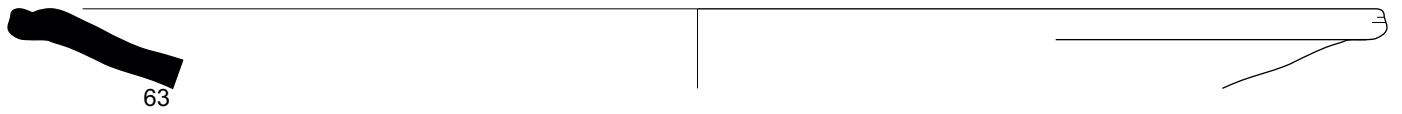
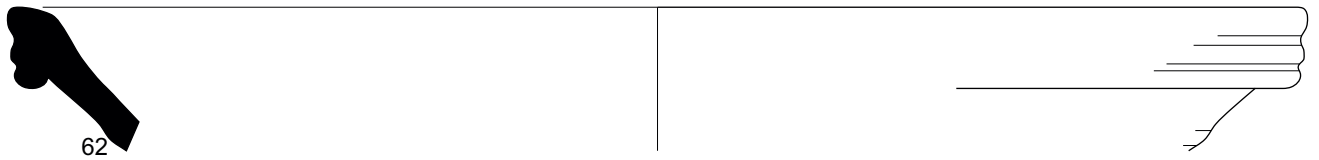
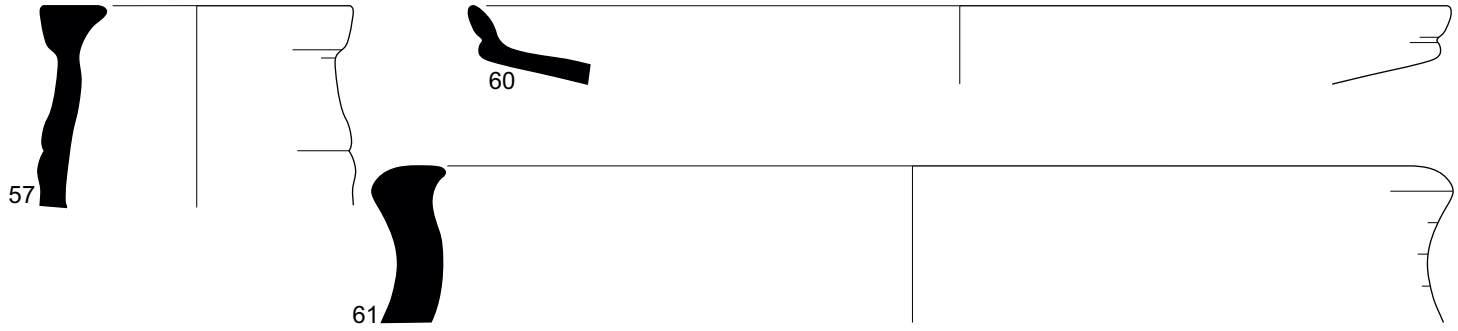
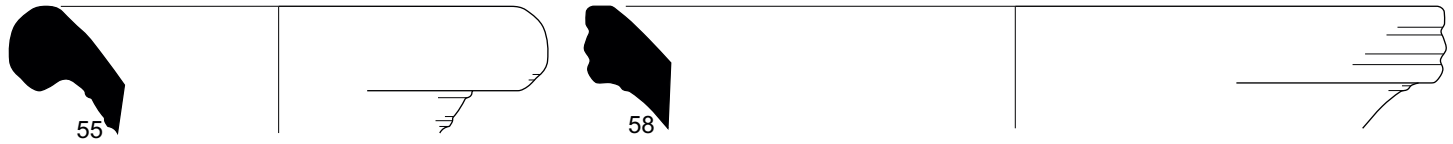

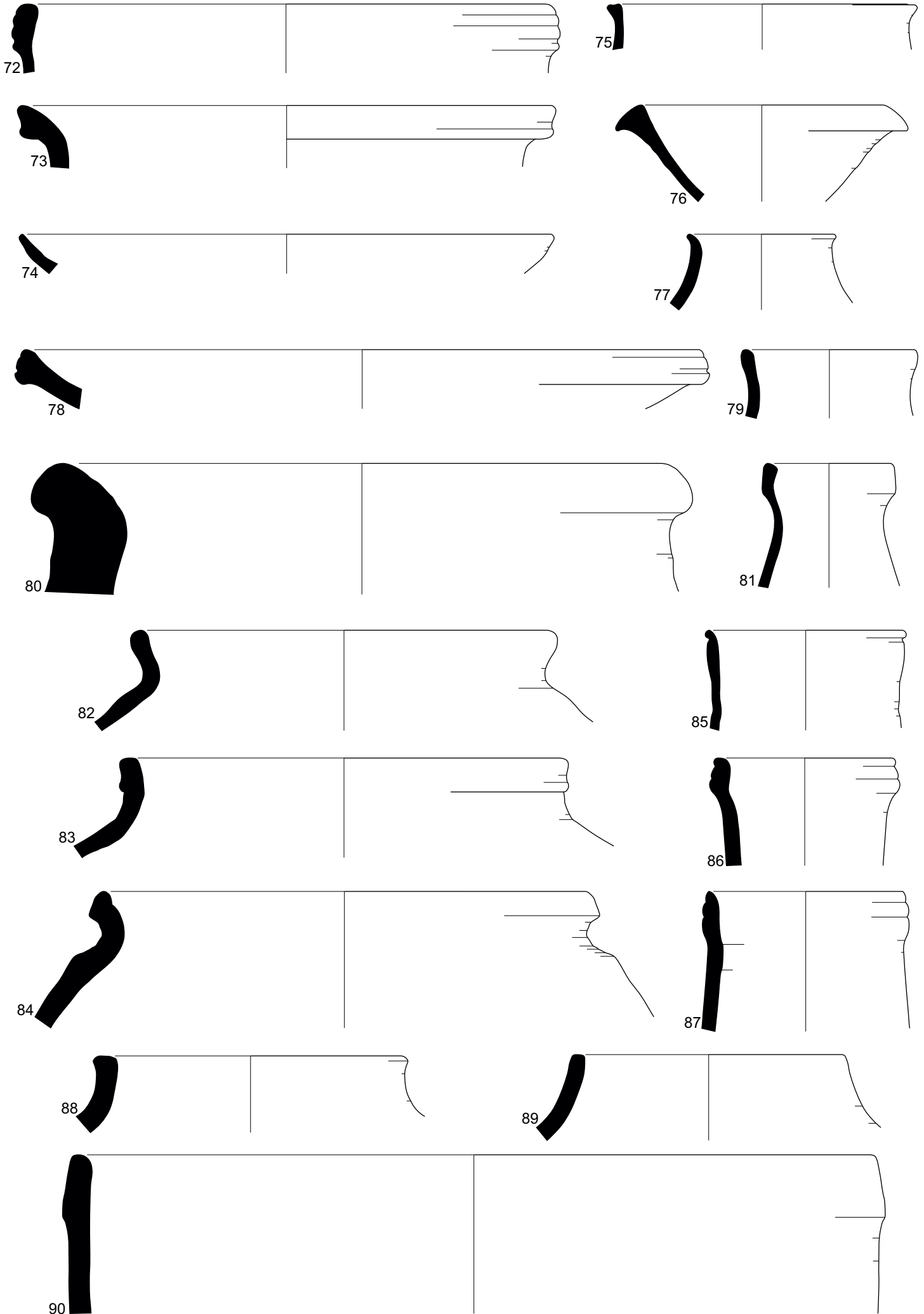

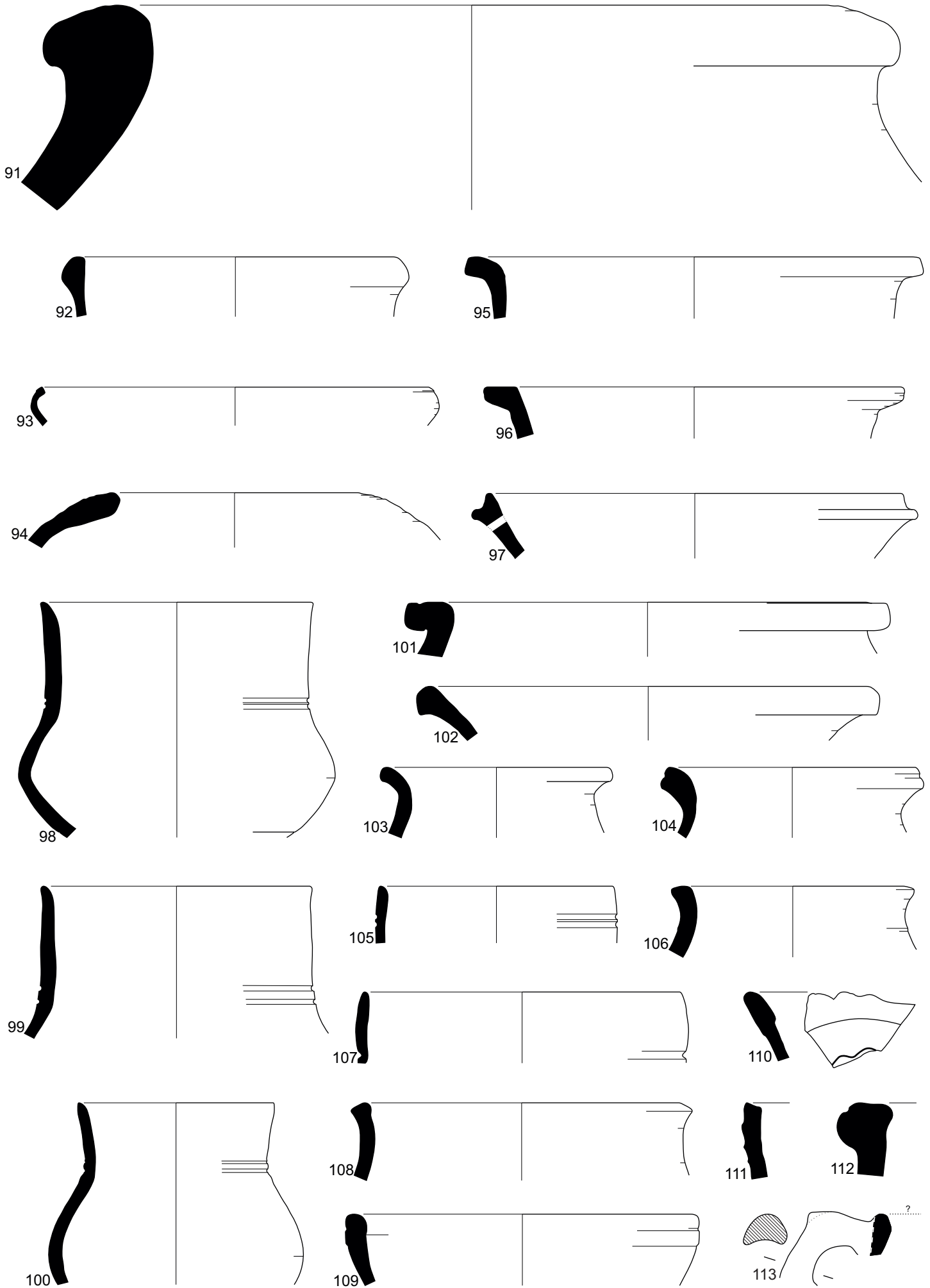

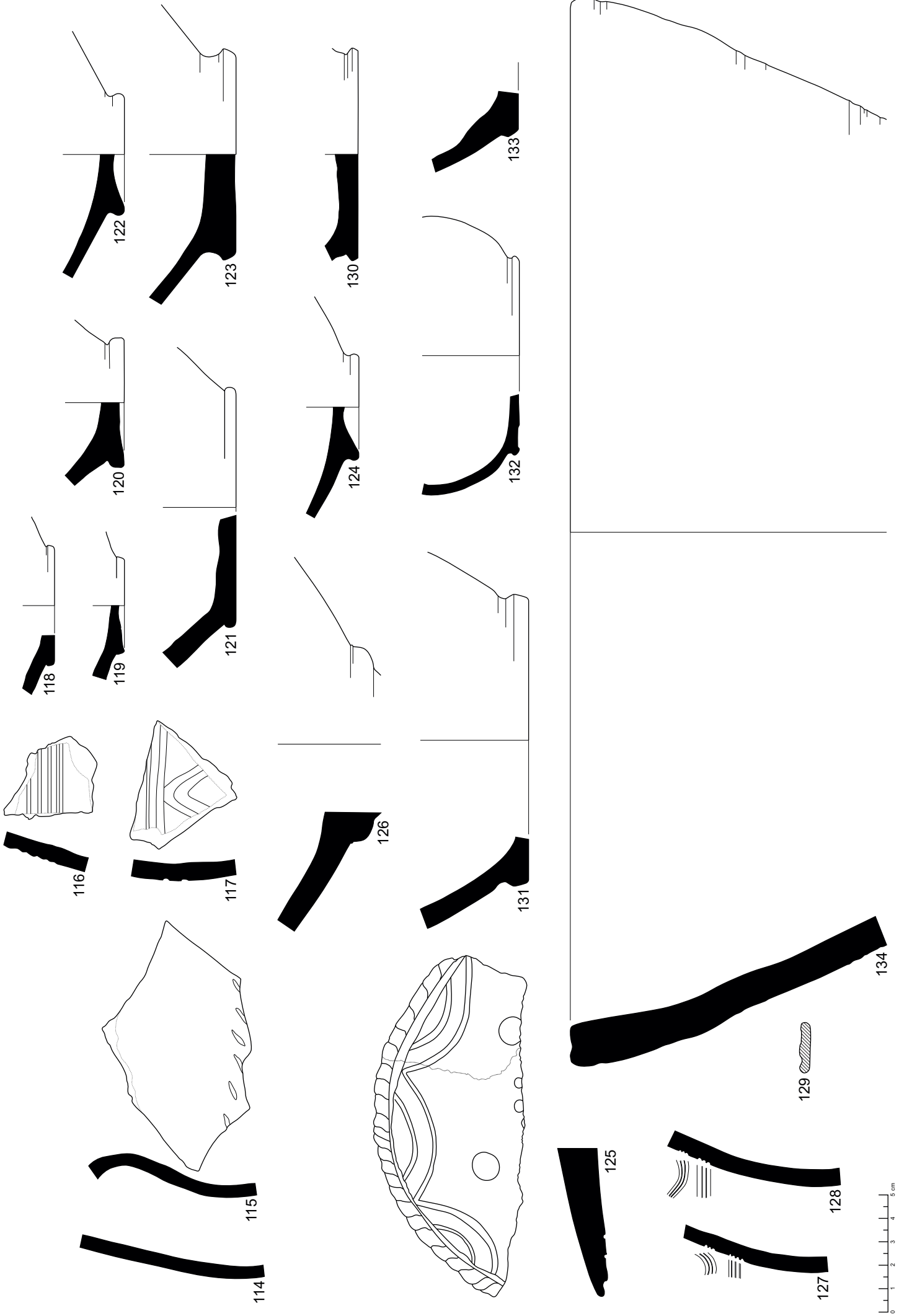

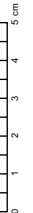
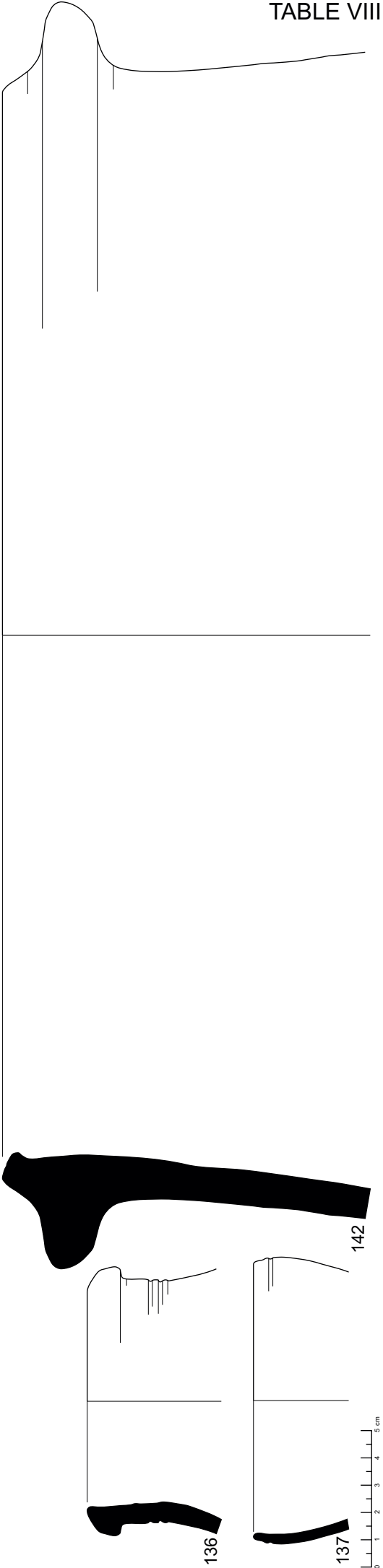
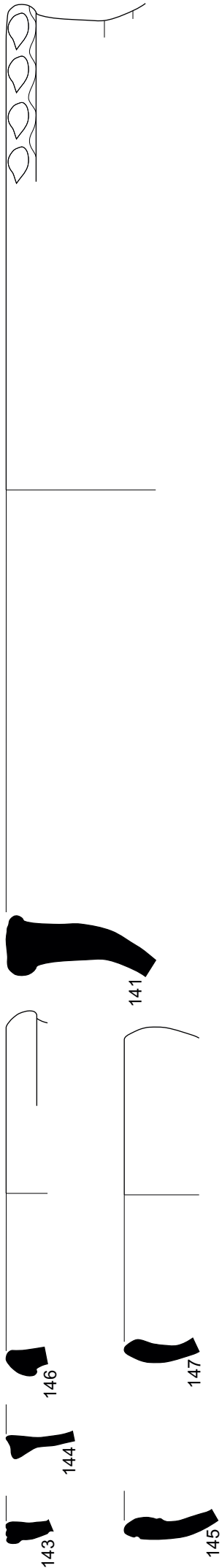
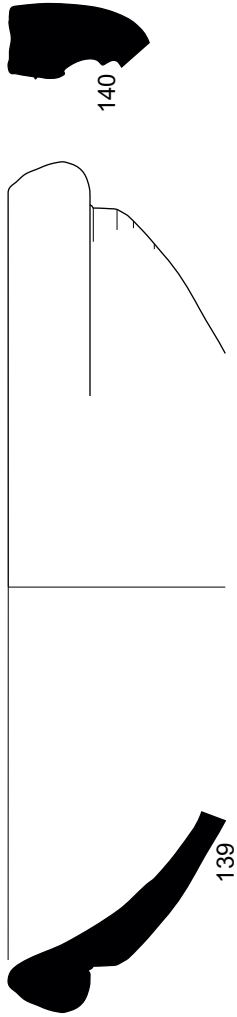
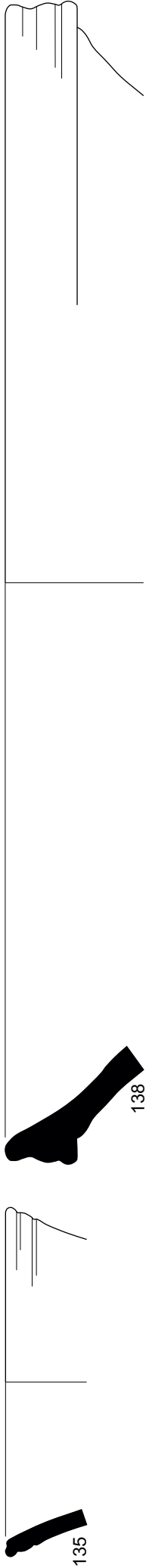

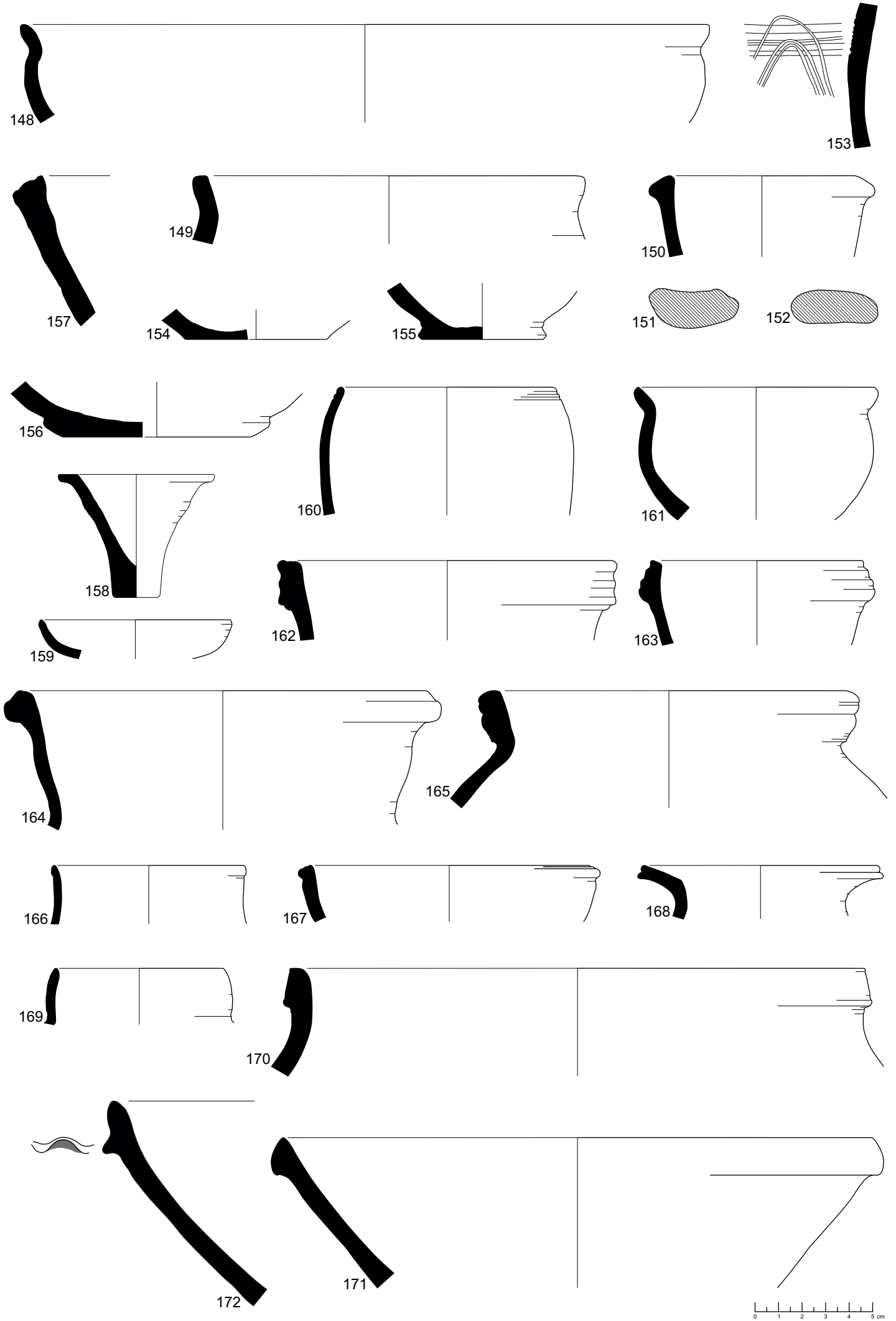

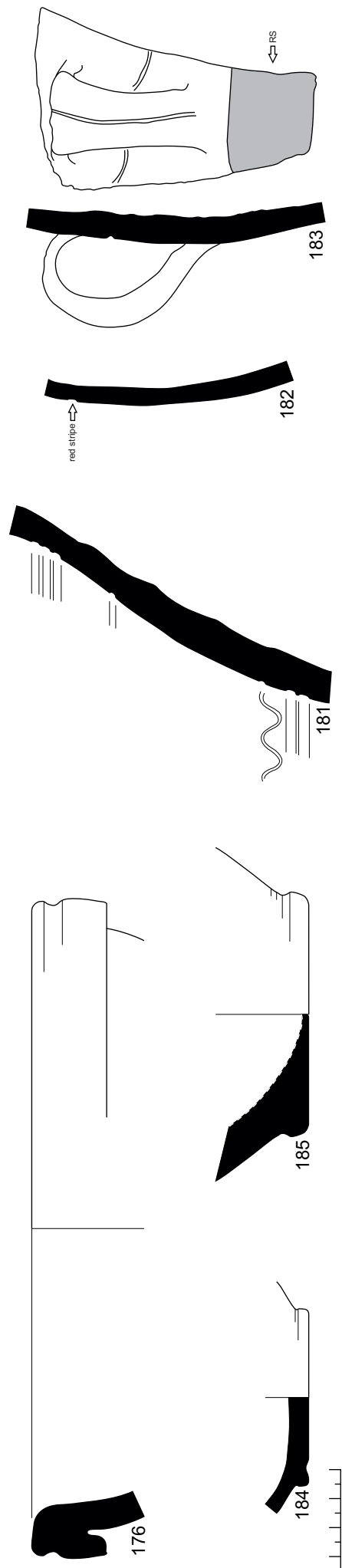
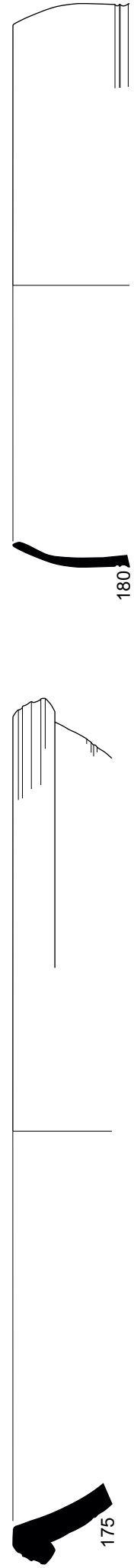
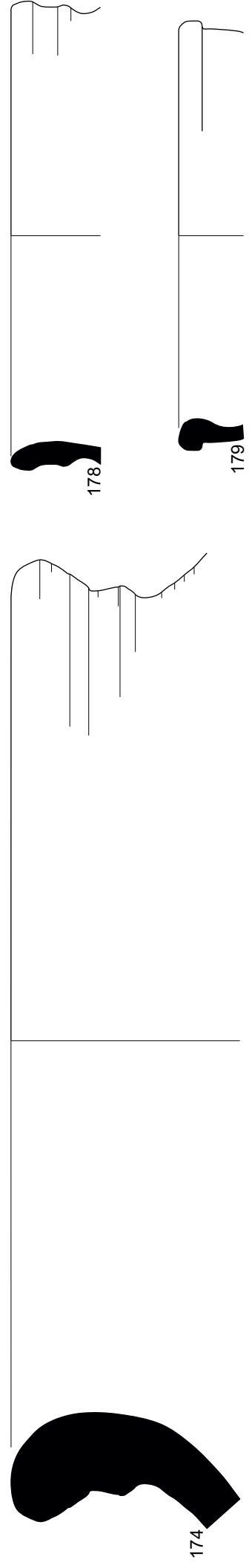
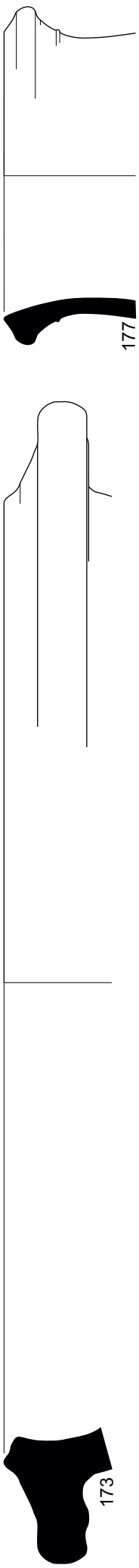

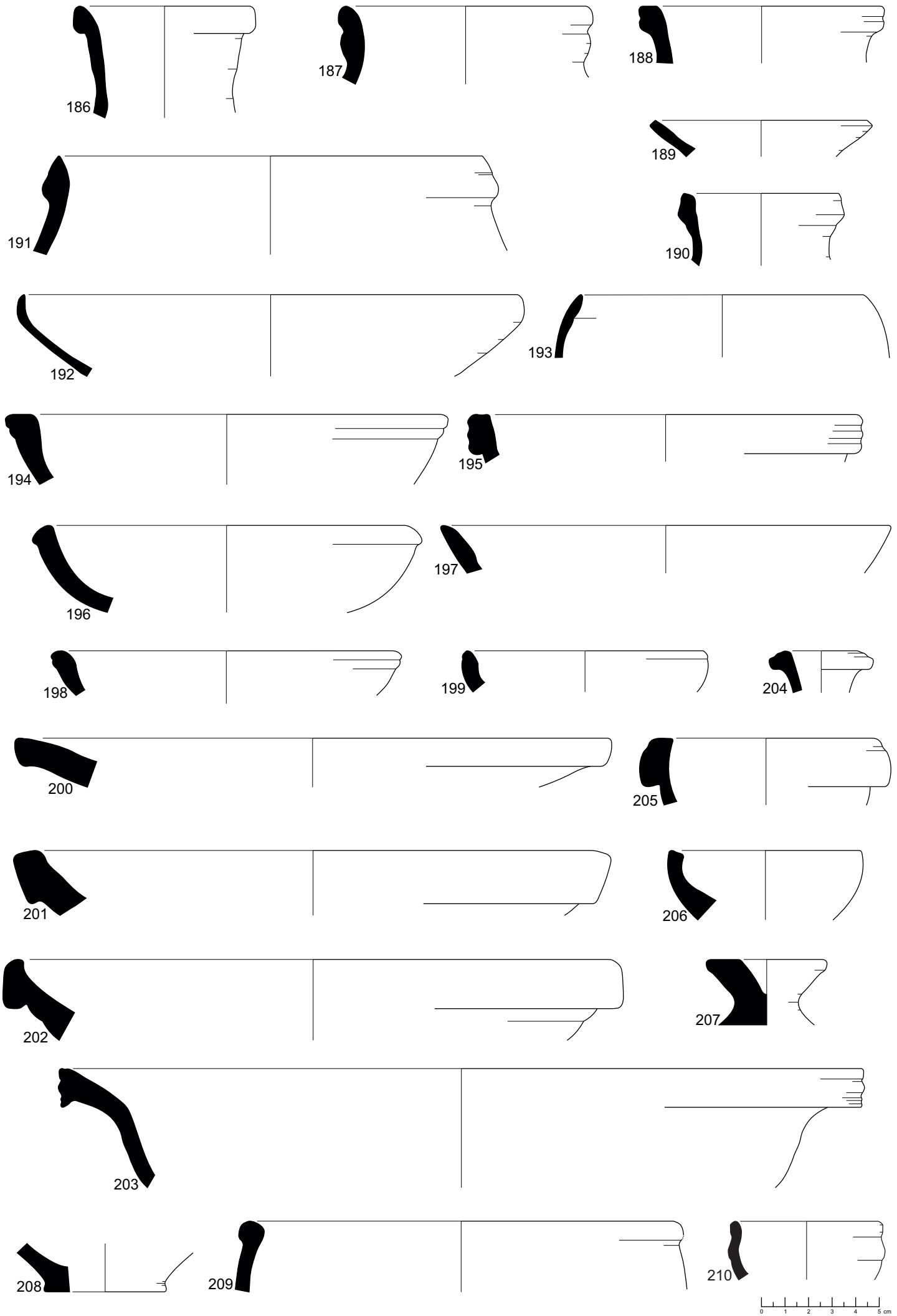



211

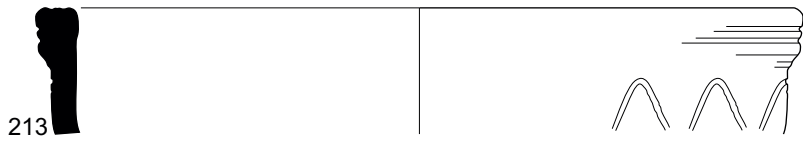

213

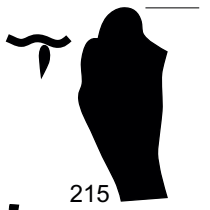

215



212

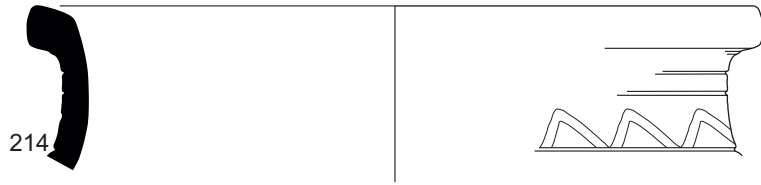

214



240



241



242

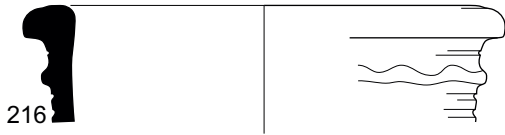

216

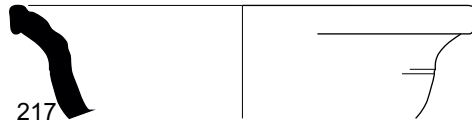

217

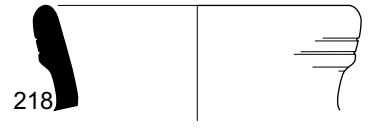

218

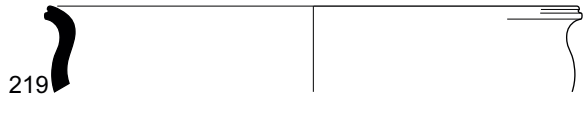

219

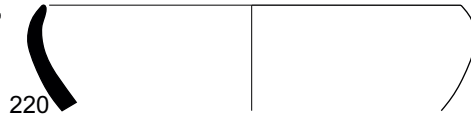

220



221

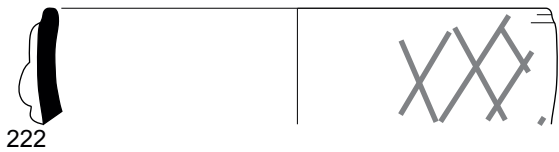

222

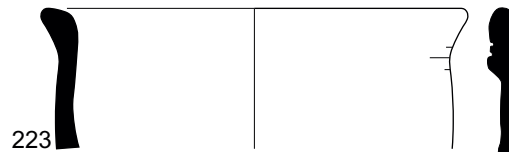

223

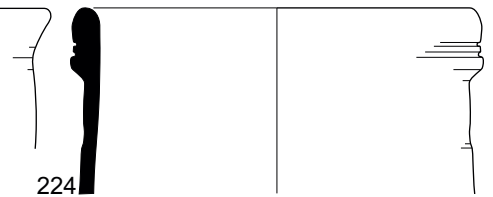

224



225

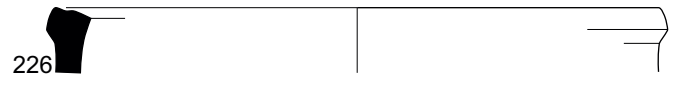

226



227

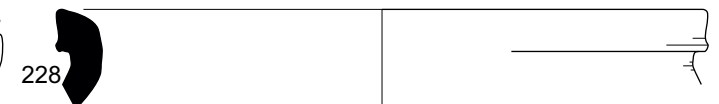

228



229



230

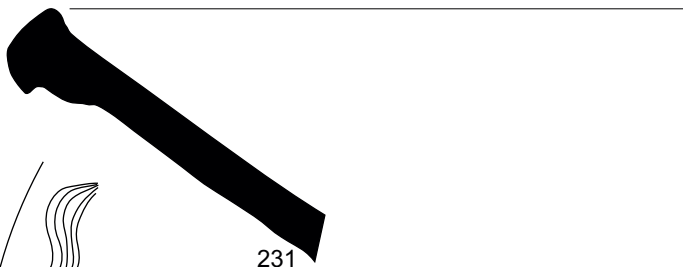

231

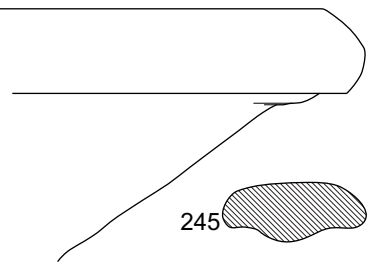

245

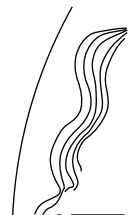

233



234



235



236



237



243

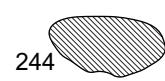

244



246



247

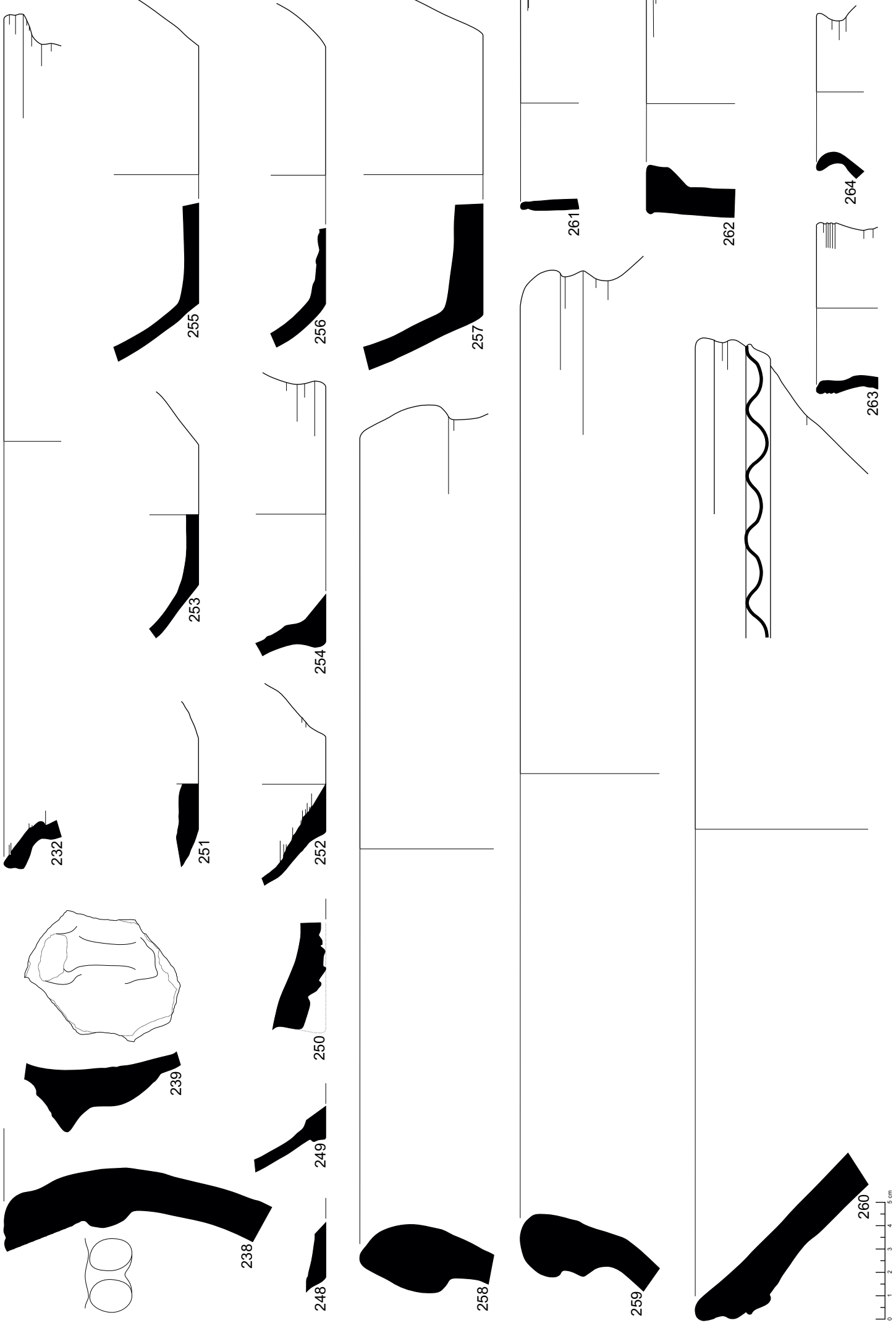

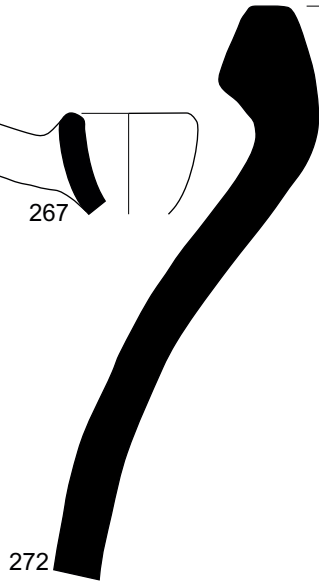
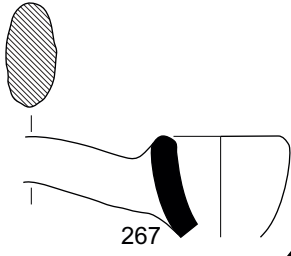

289

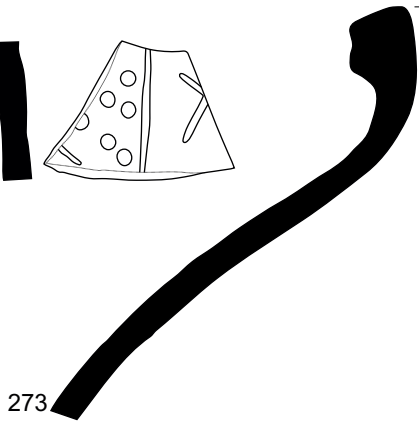
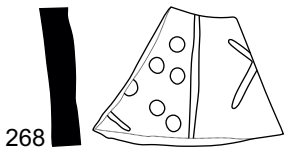

290



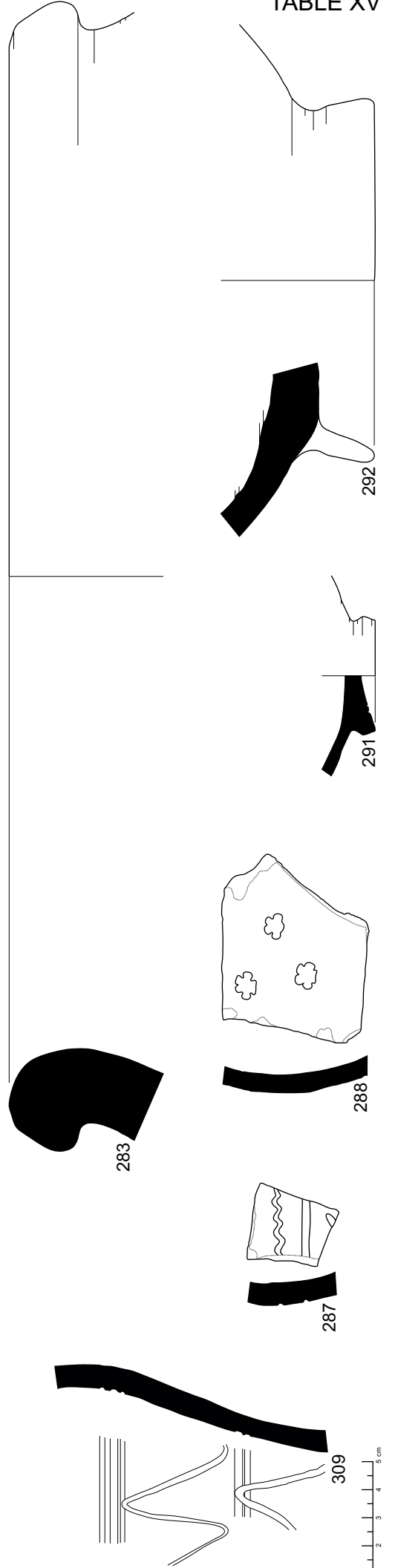
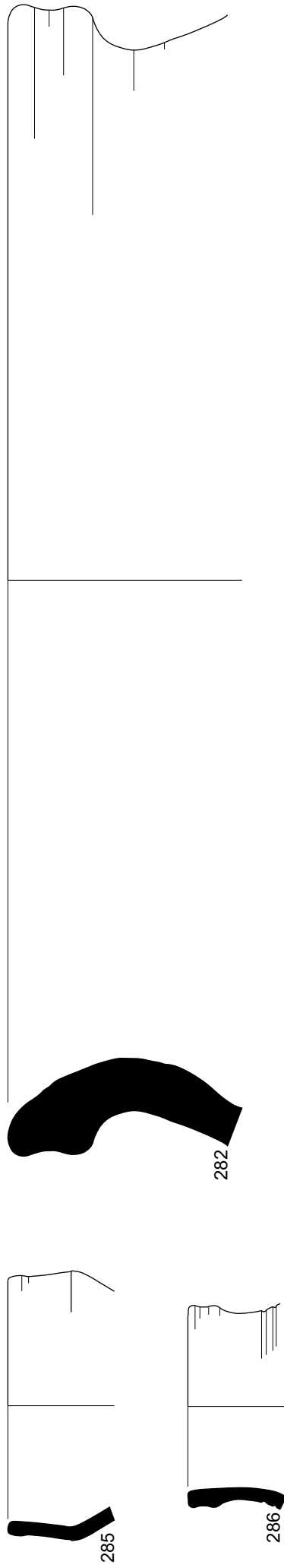
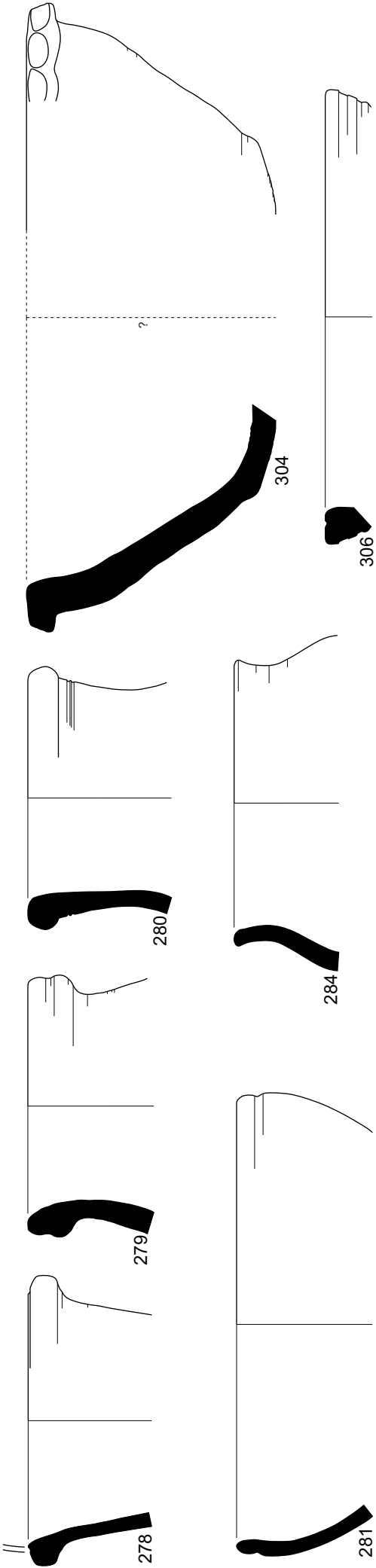

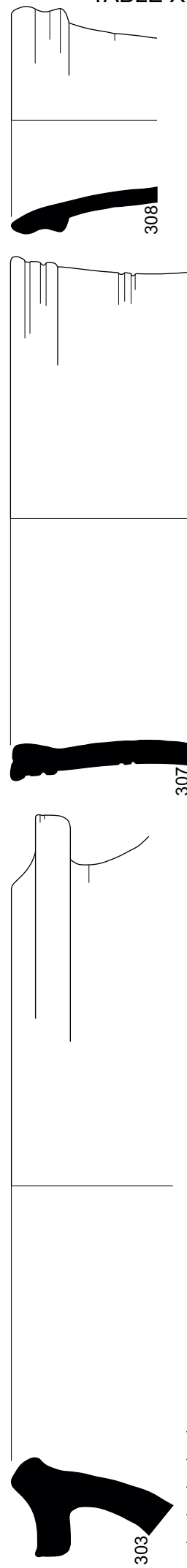
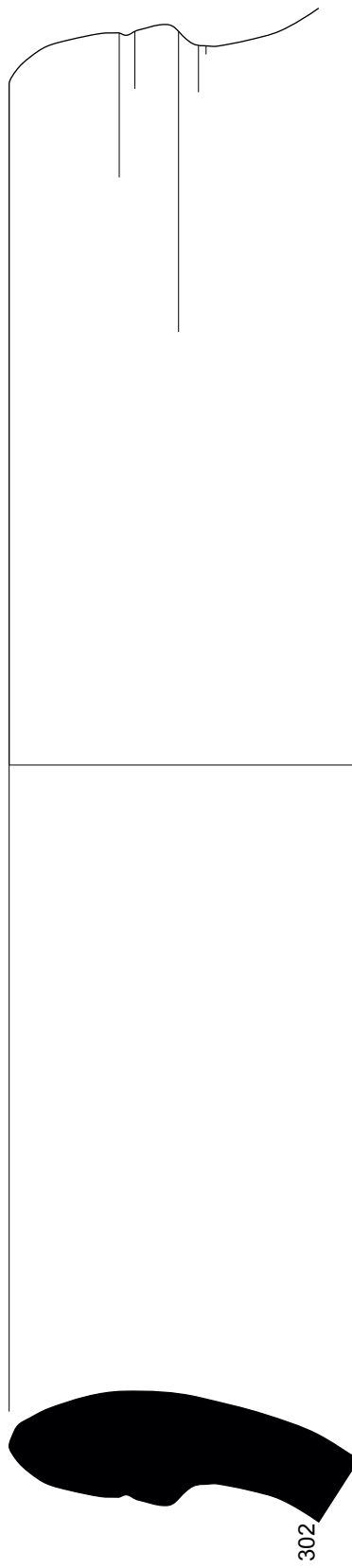
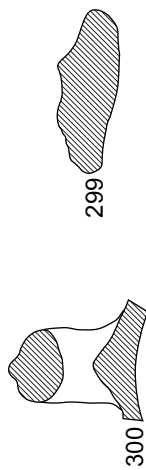
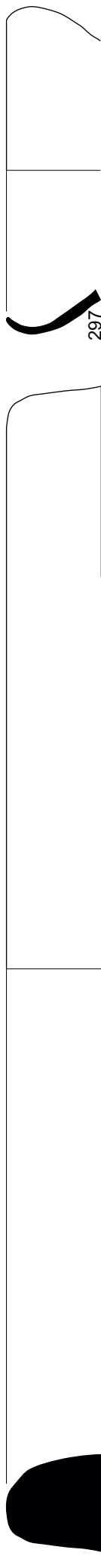
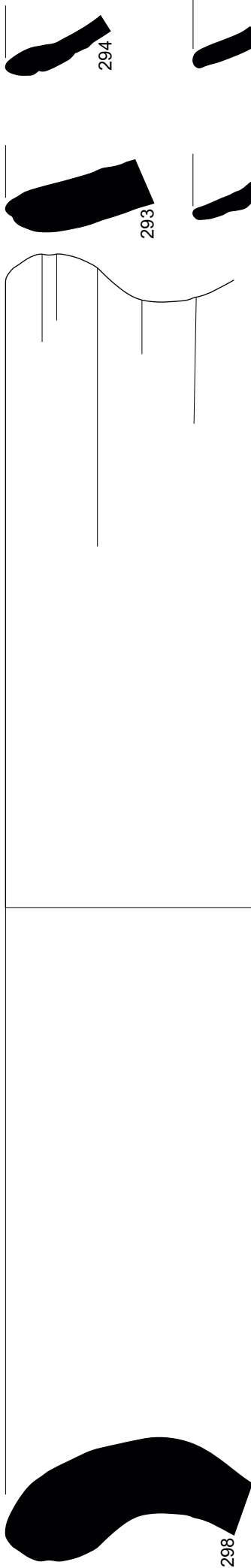



311

312

313

314

315

316

319

318

320

322

321

323

324

325

327

328

326

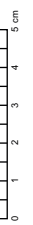
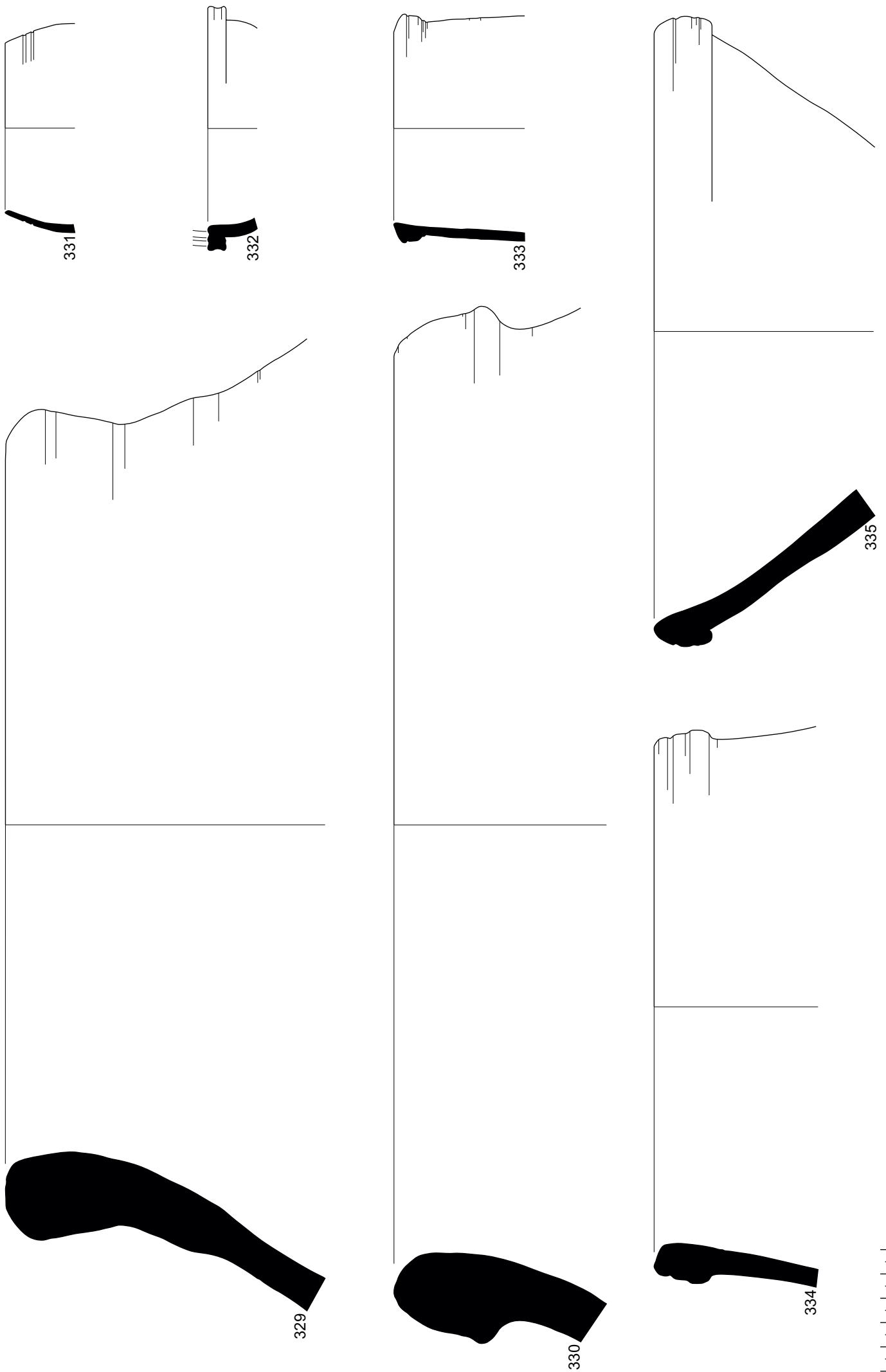

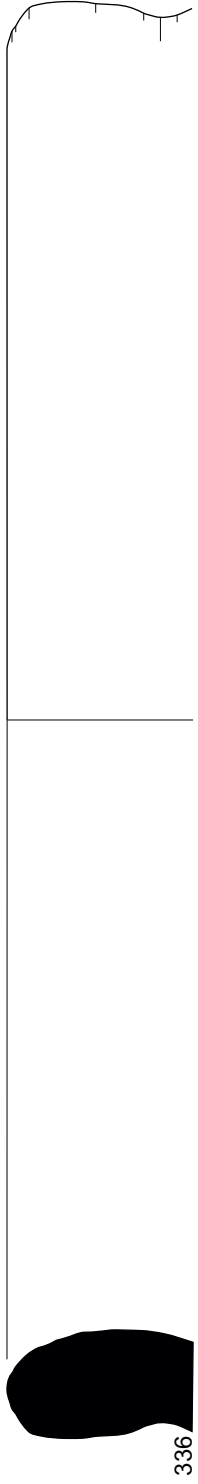

336

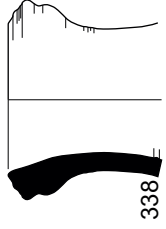

338

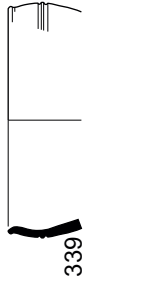

339

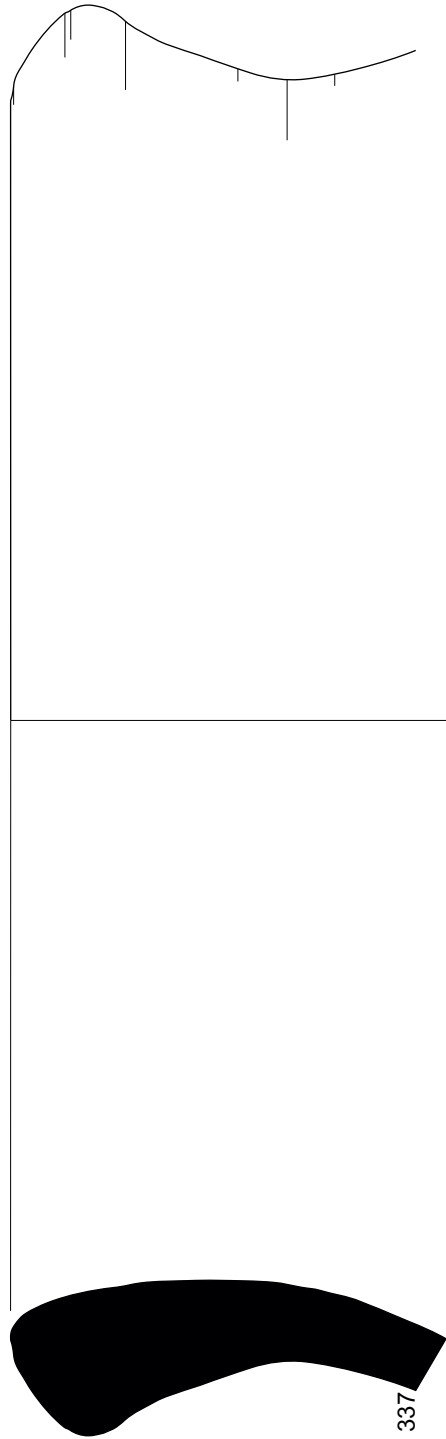

337

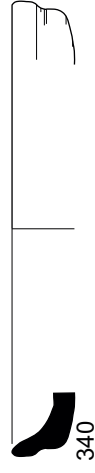

340



341

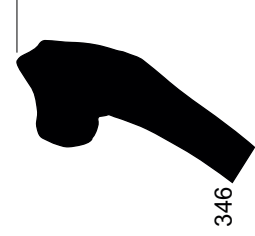

346



347

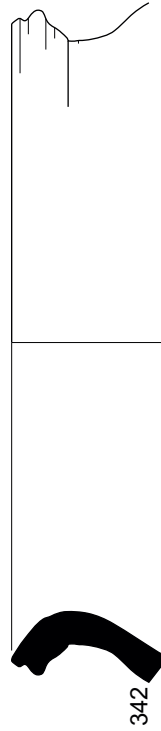

342

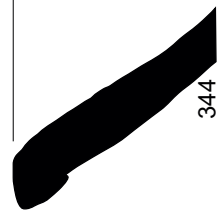

344

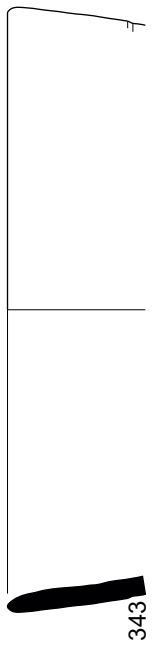
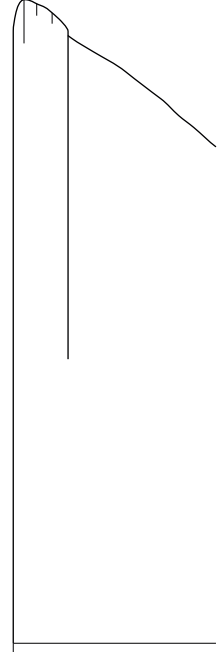

343

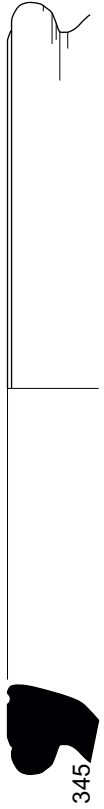

345

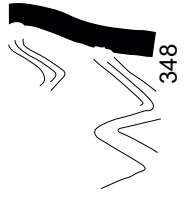

348



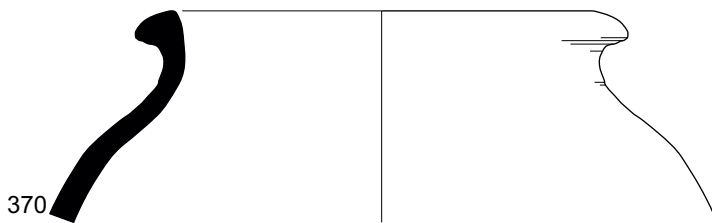
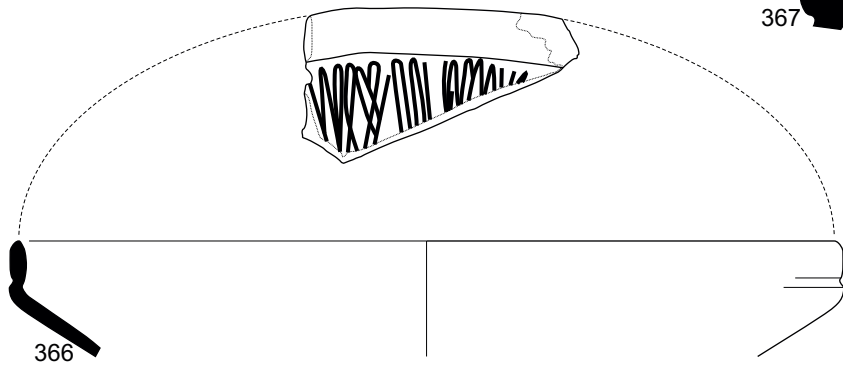
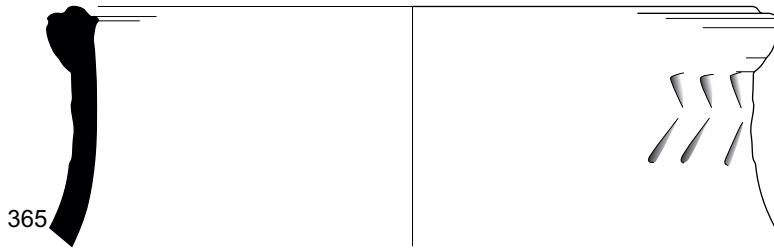
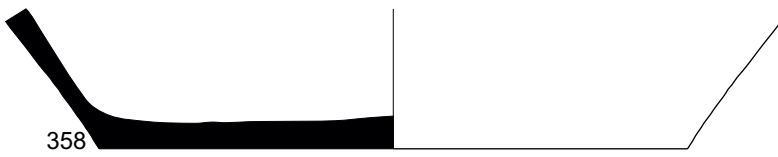
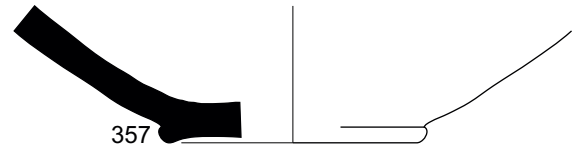
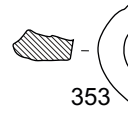
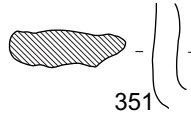
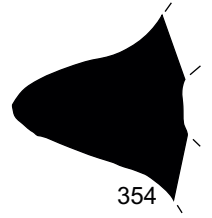
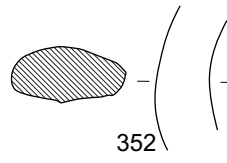
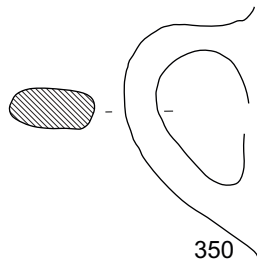
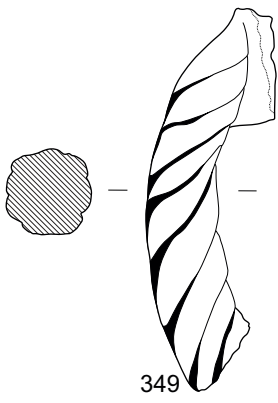

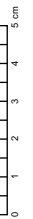
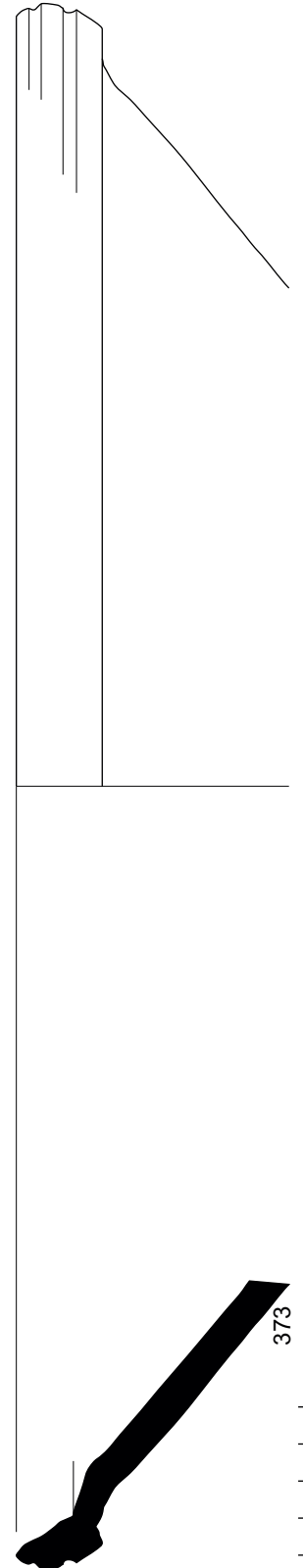
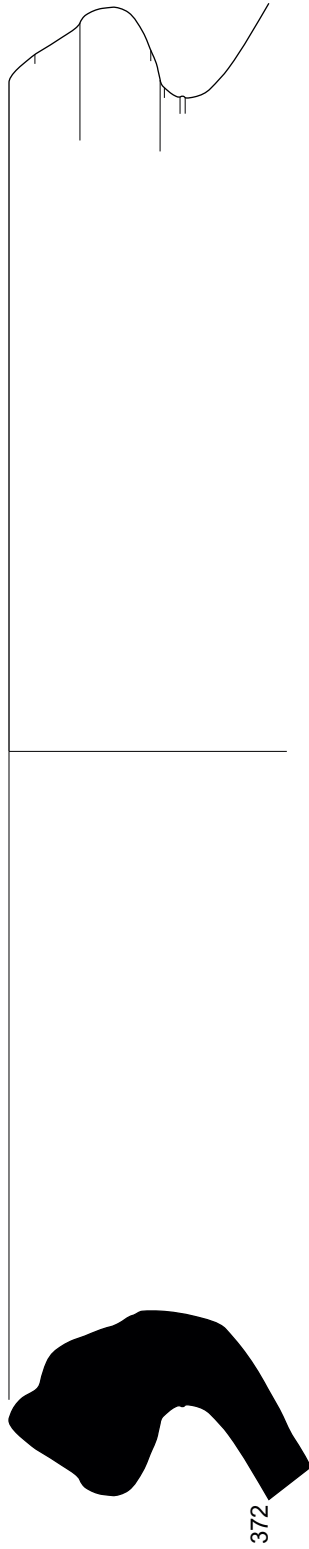
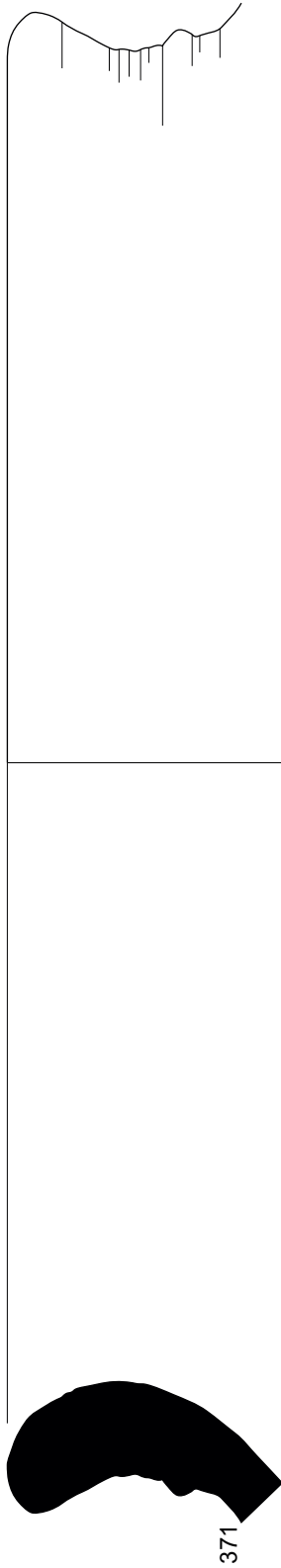
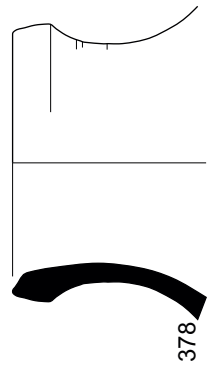
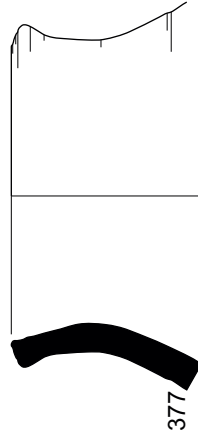
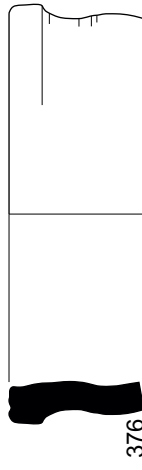
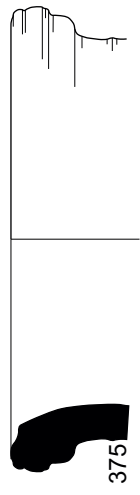
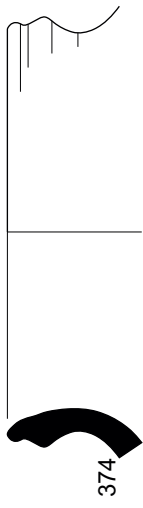

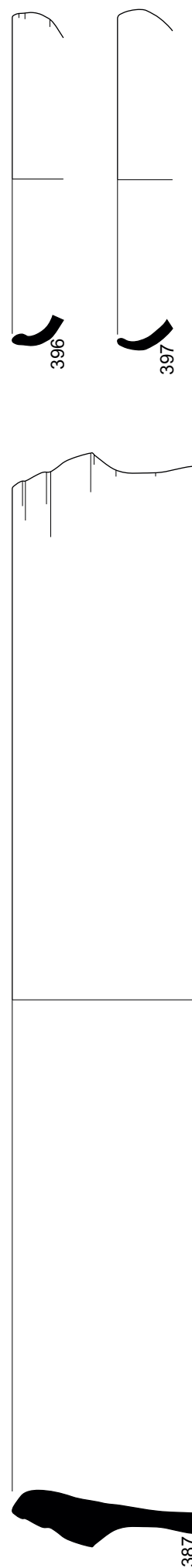
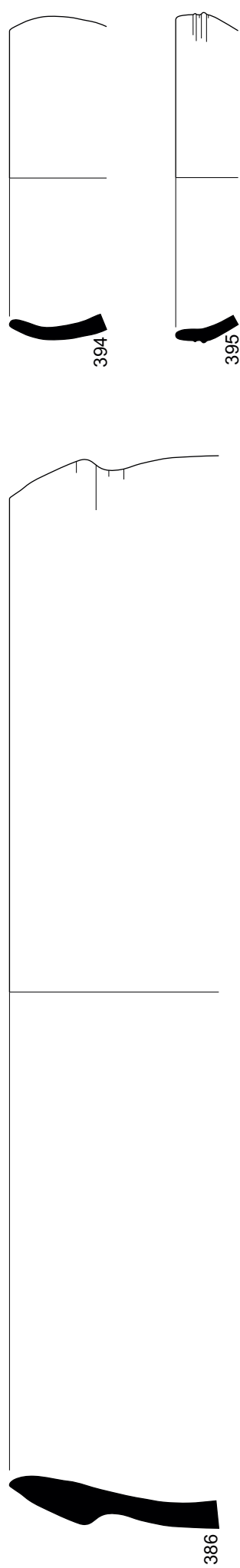
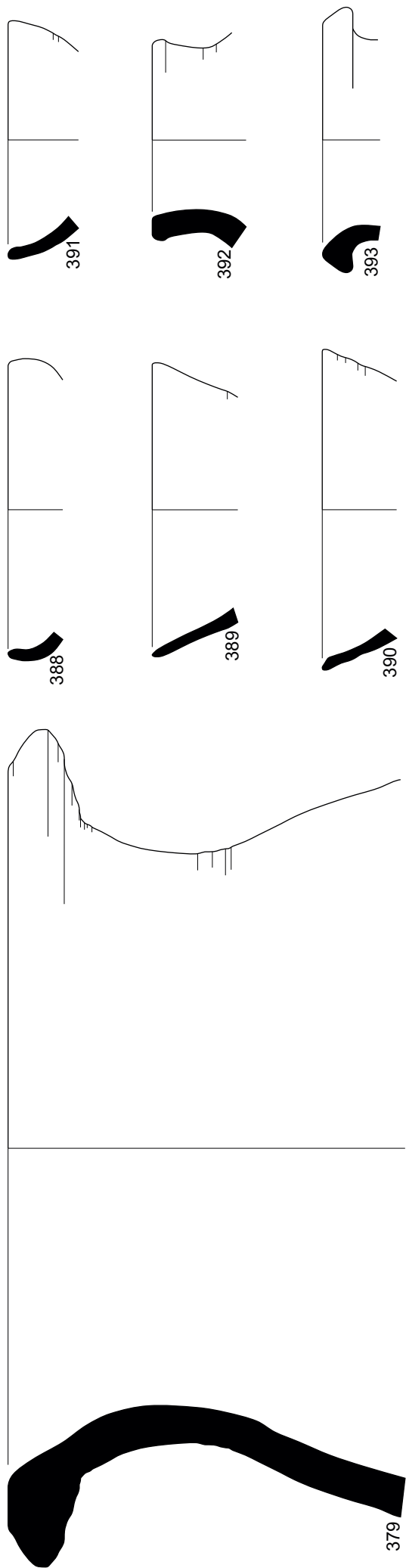



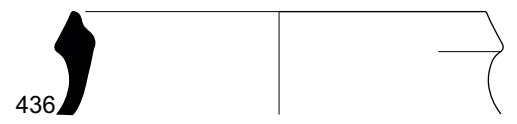
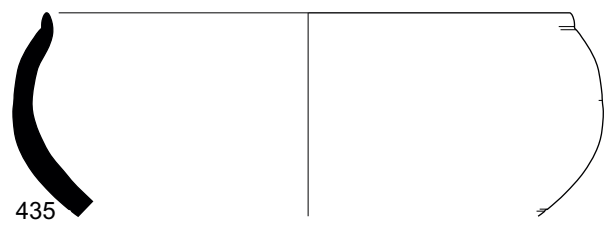
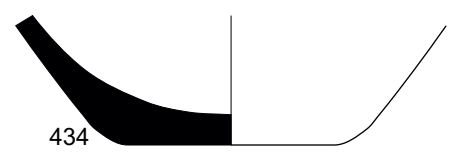
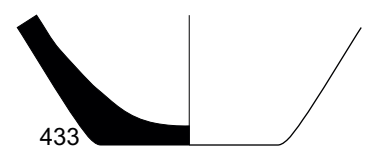
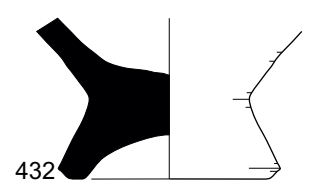
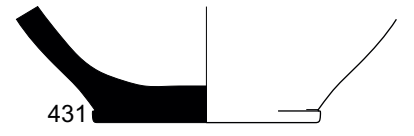
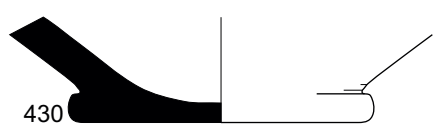
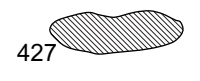
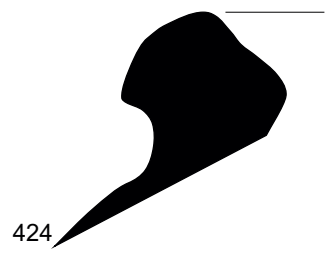
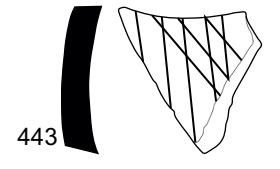
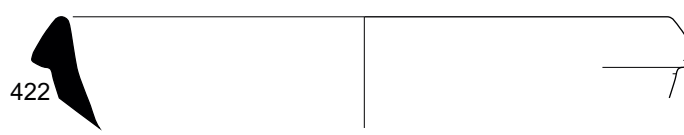
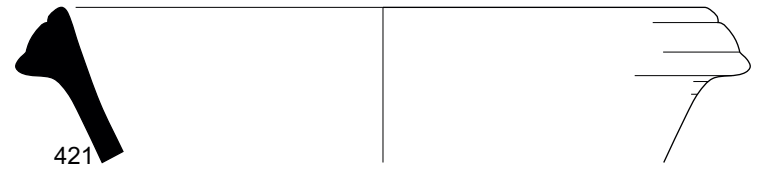
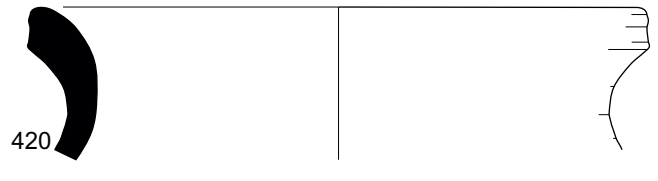
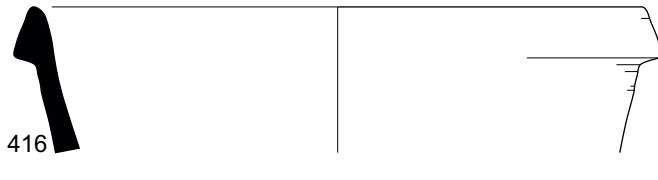

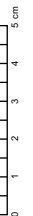
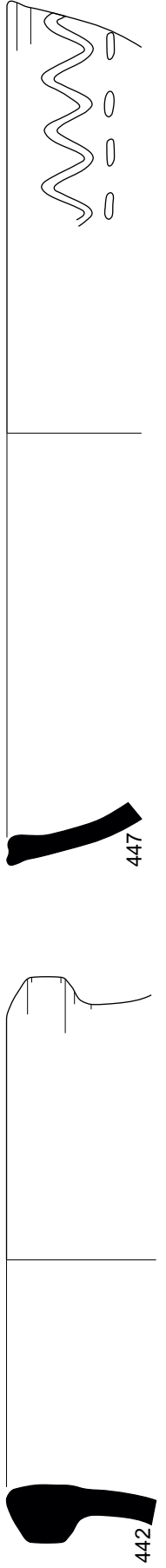
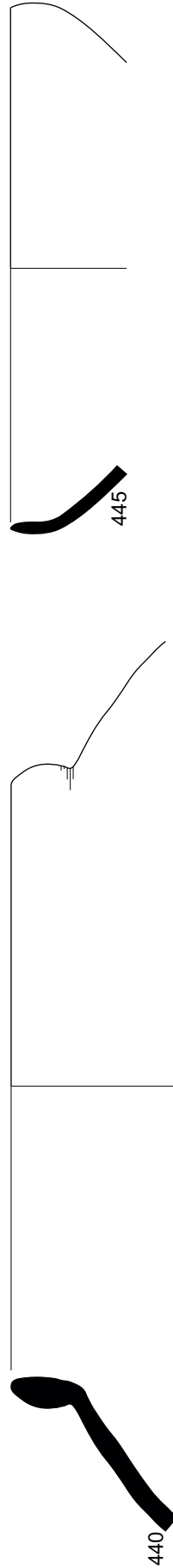
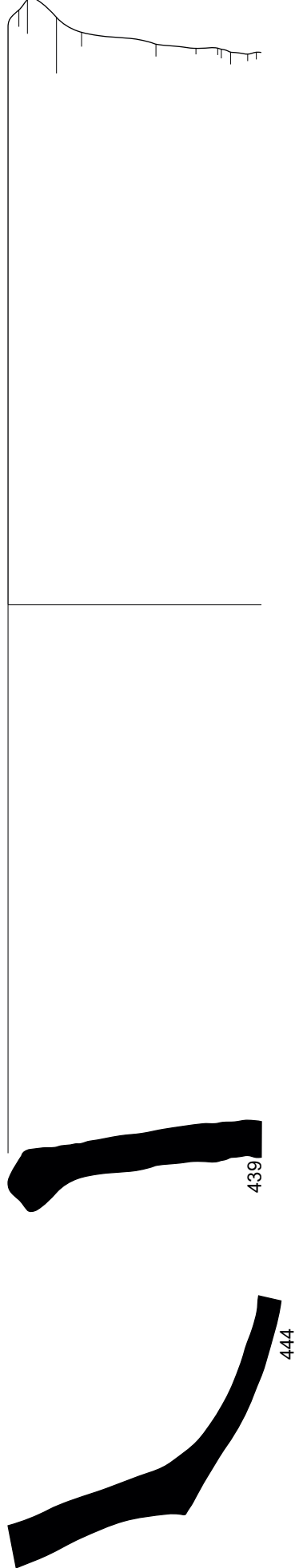
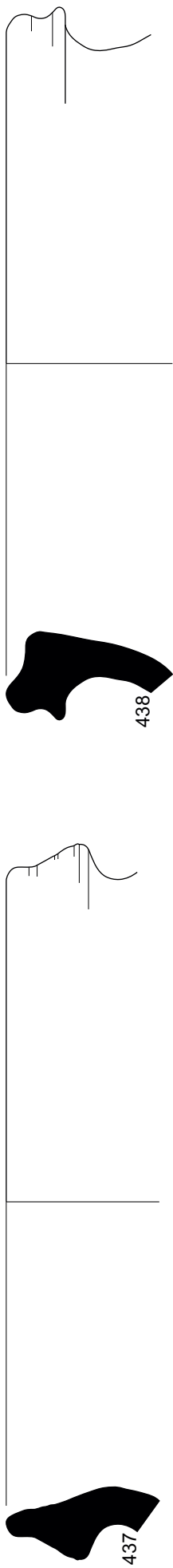

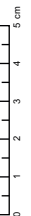
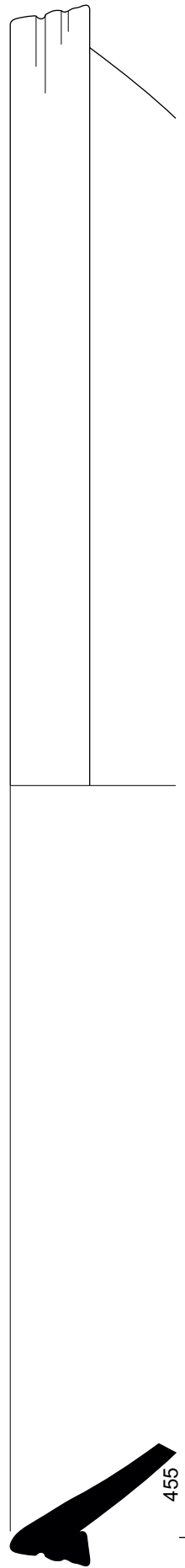
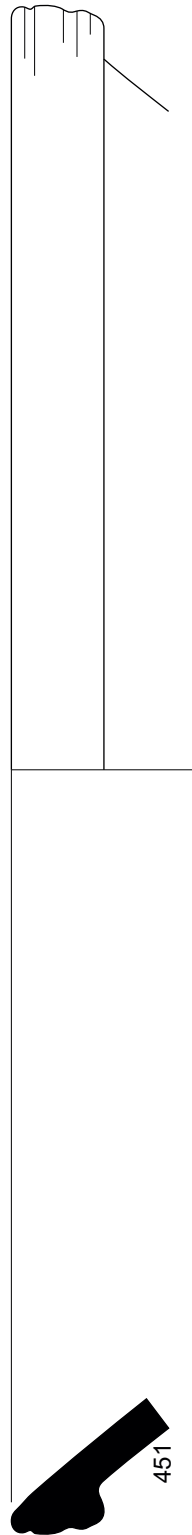
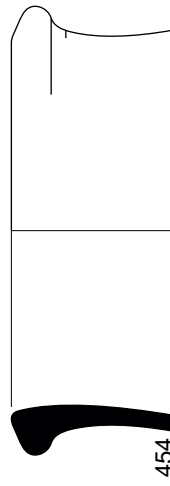
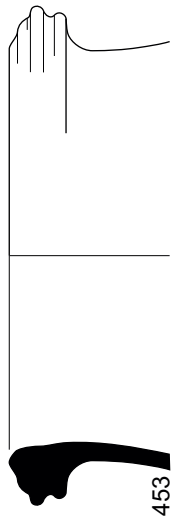
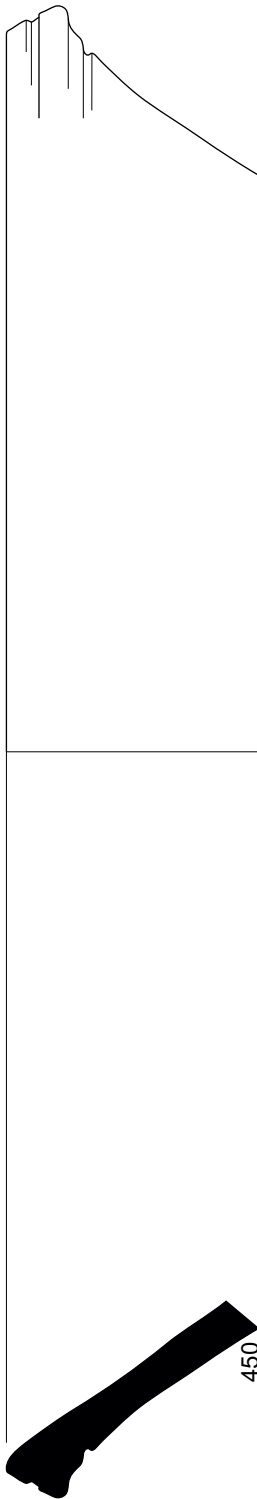
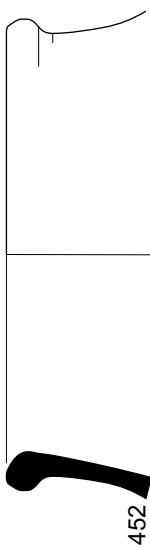
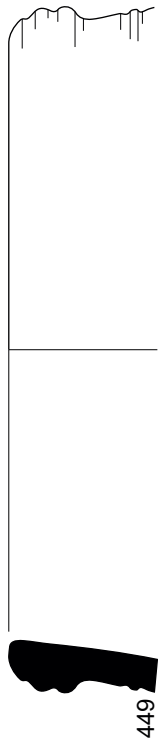

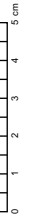
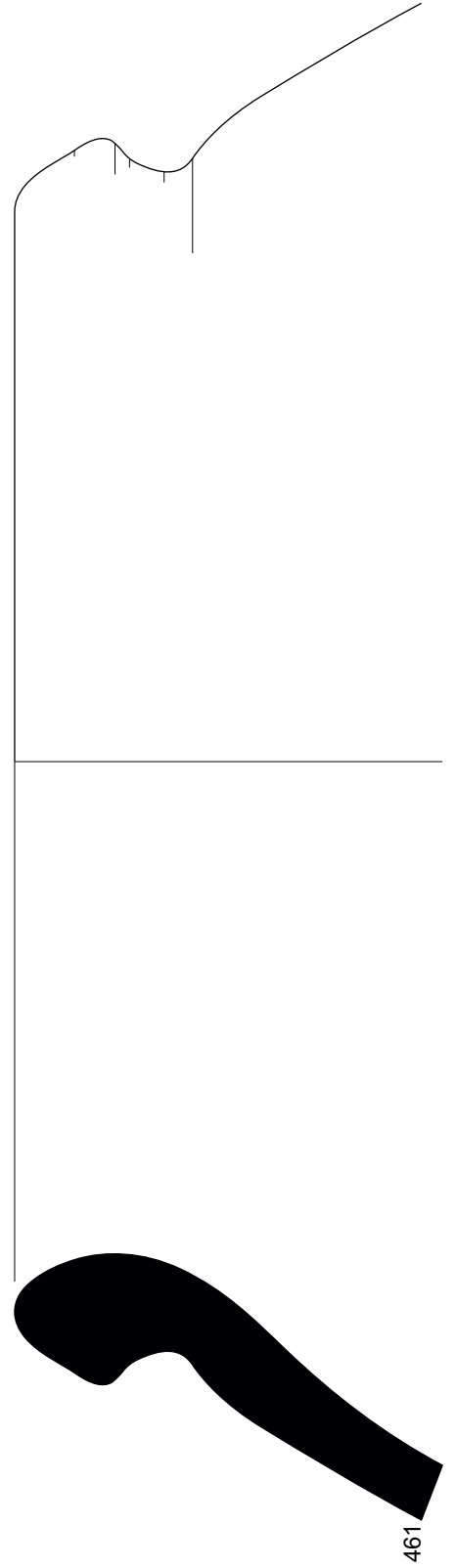
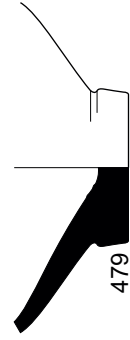
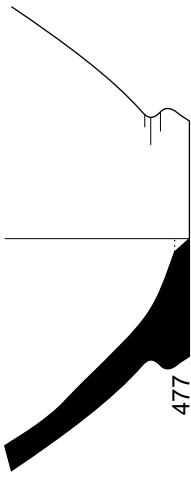
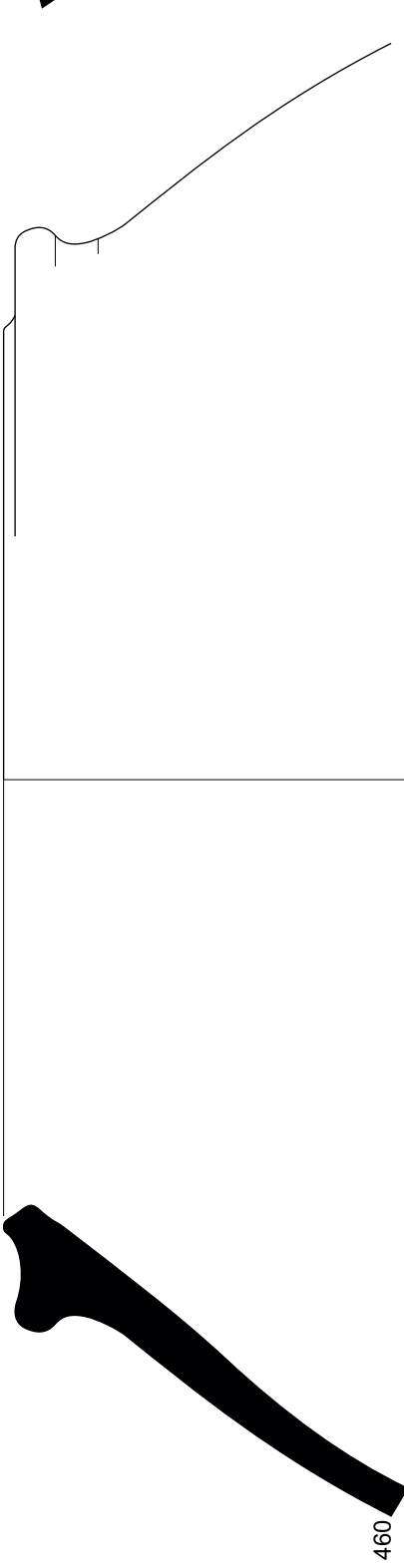
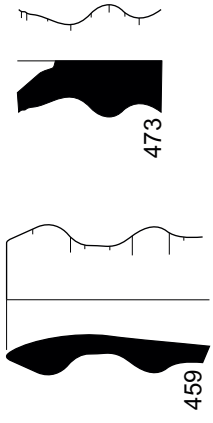
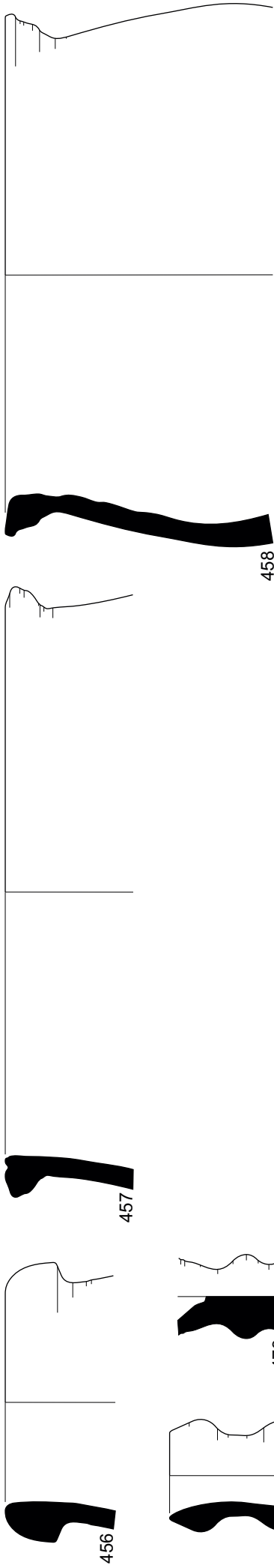

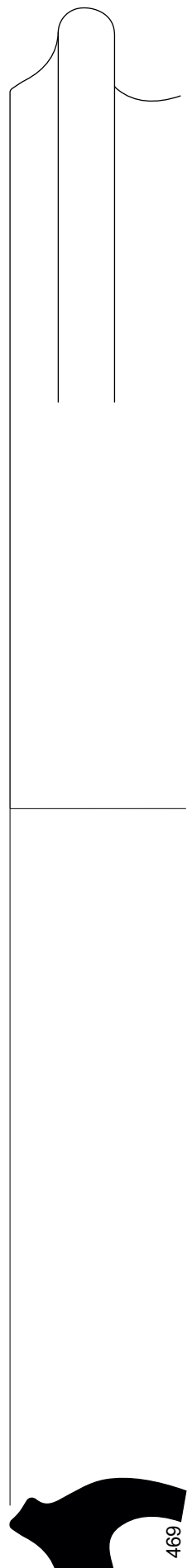
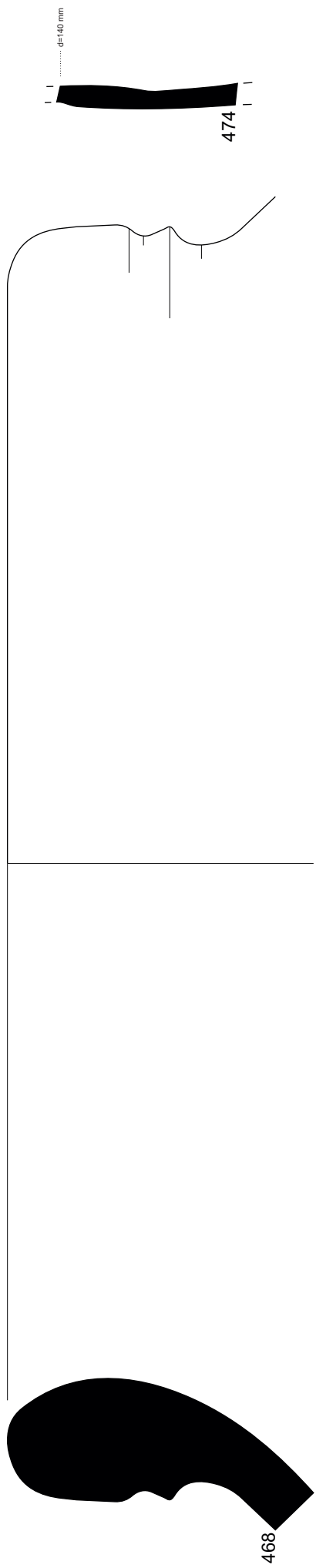
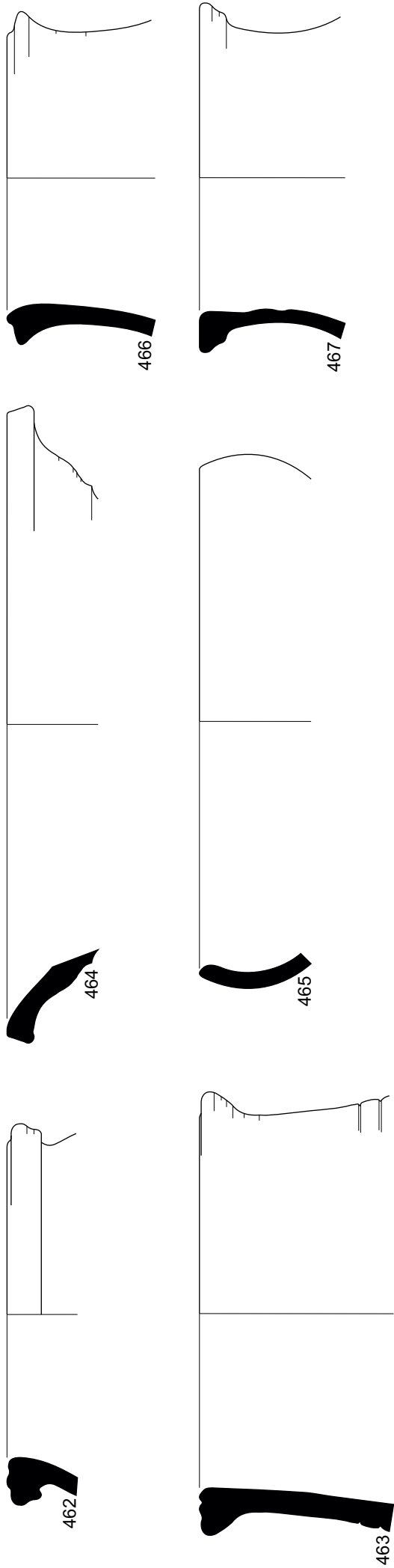

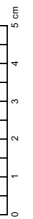
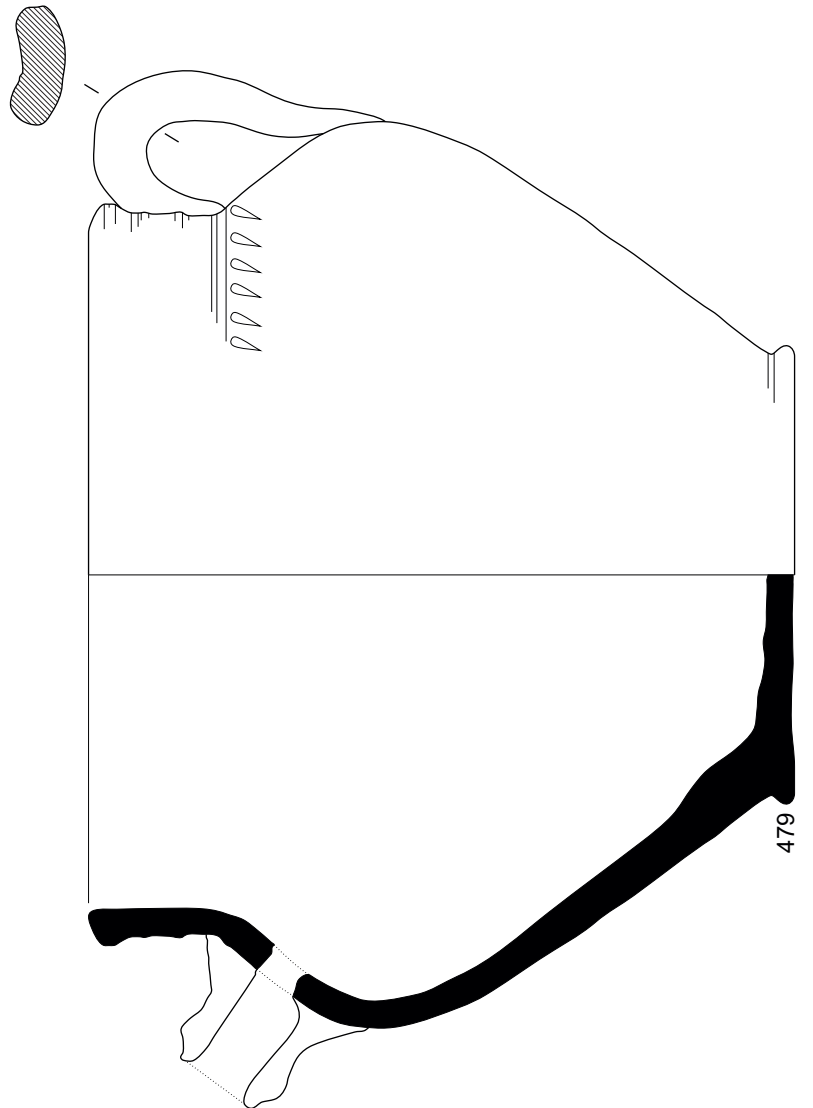
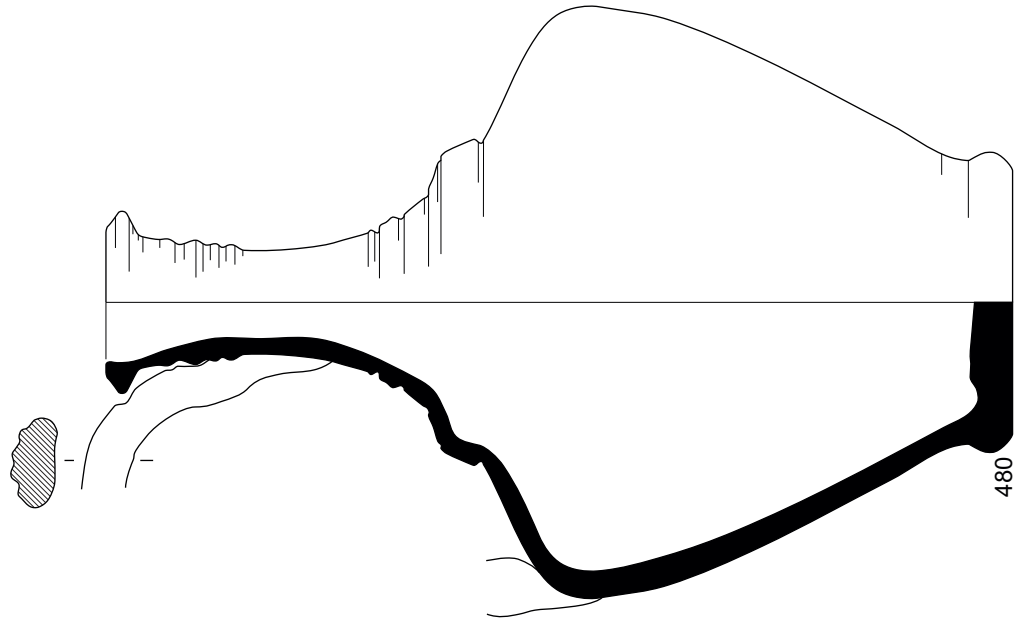

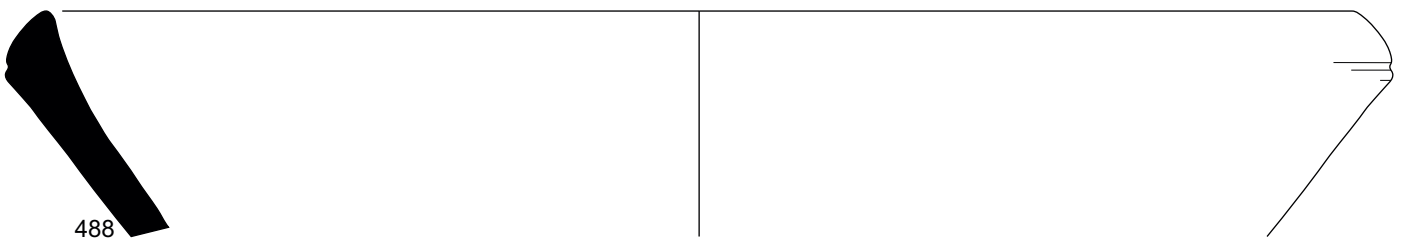
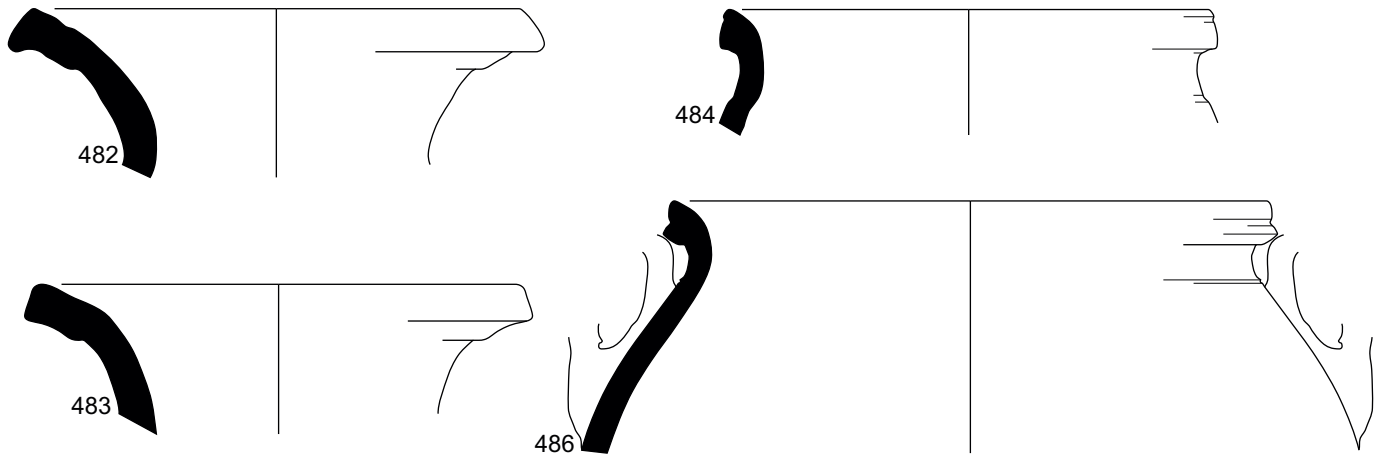
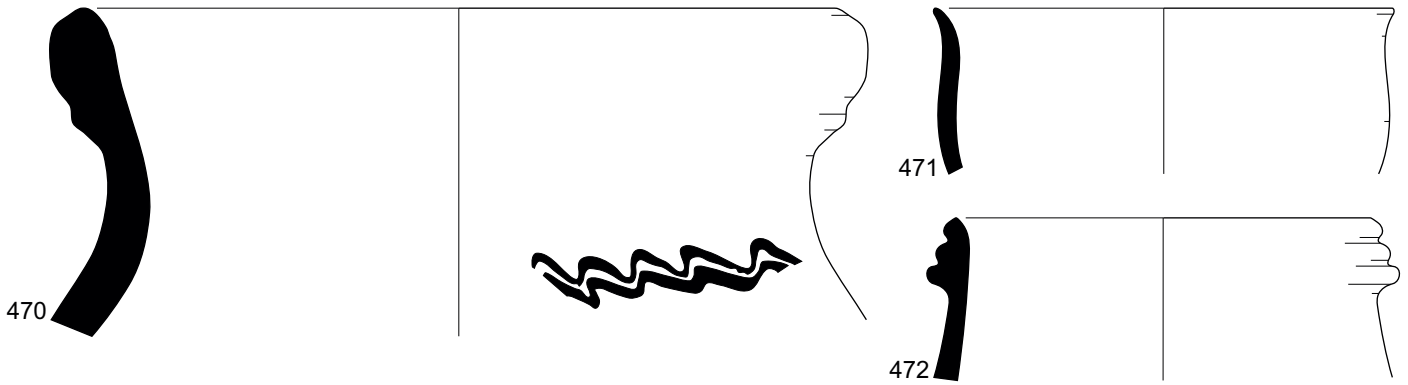

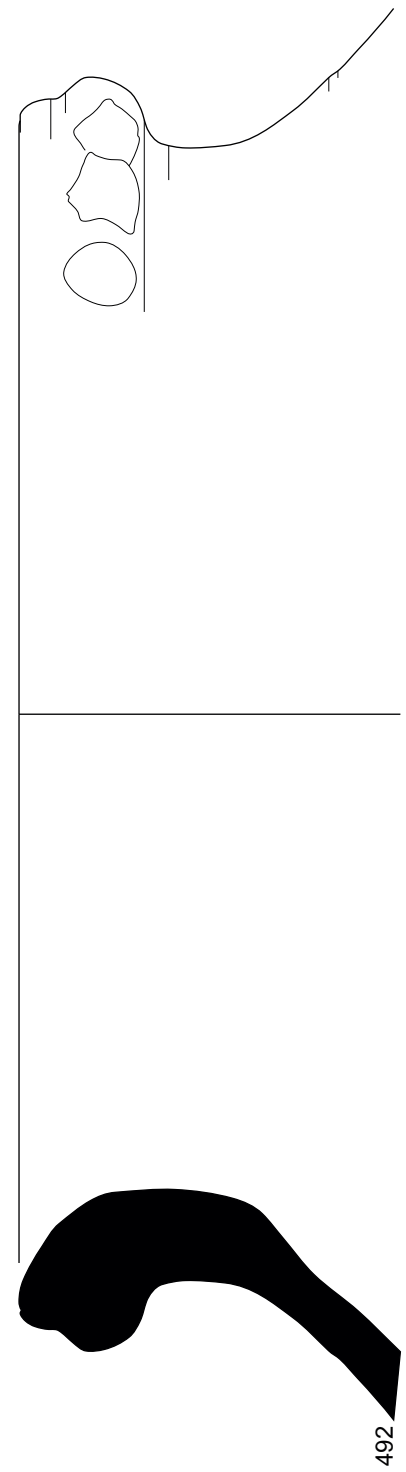
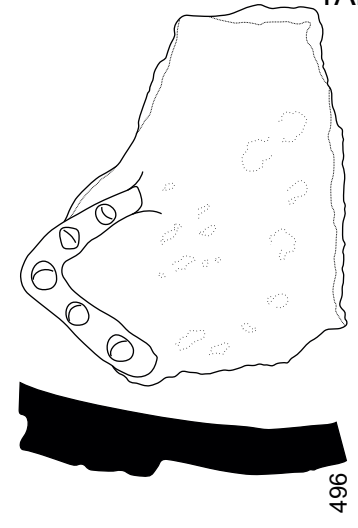
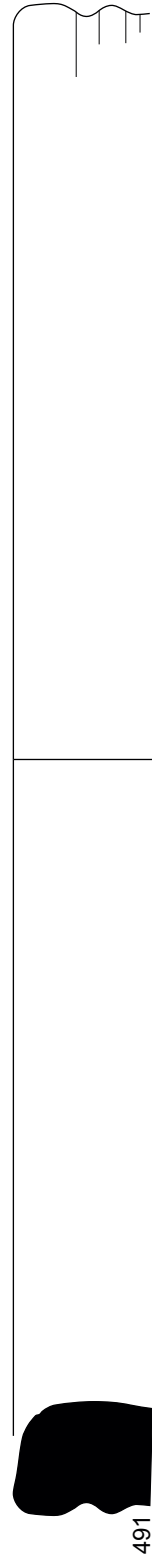
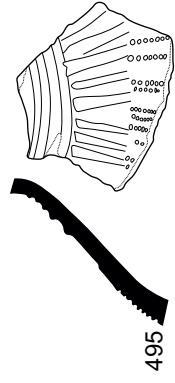
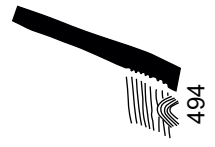
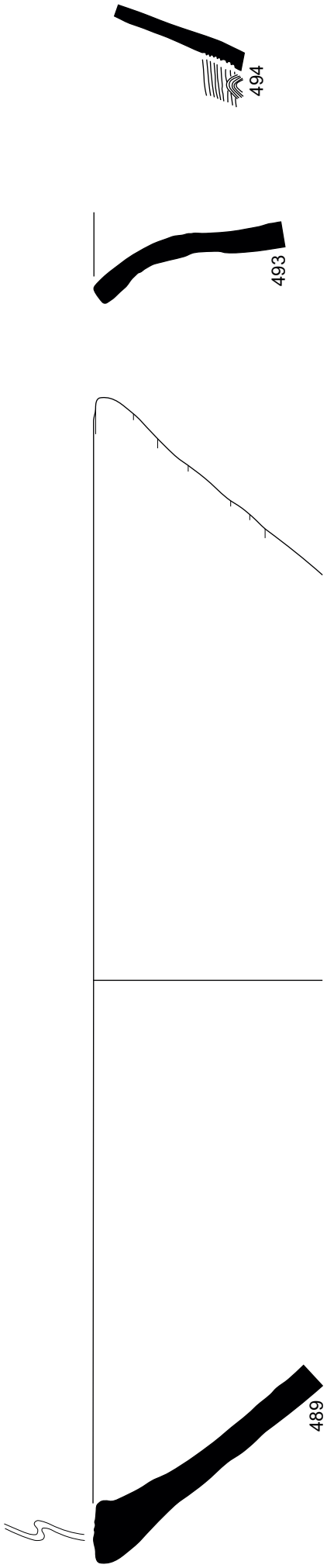

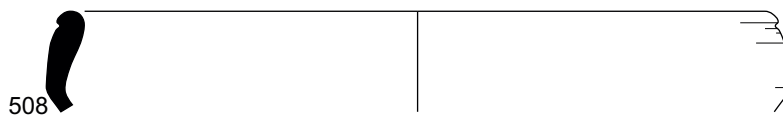
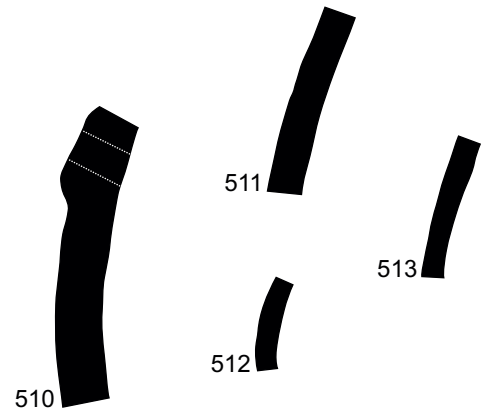
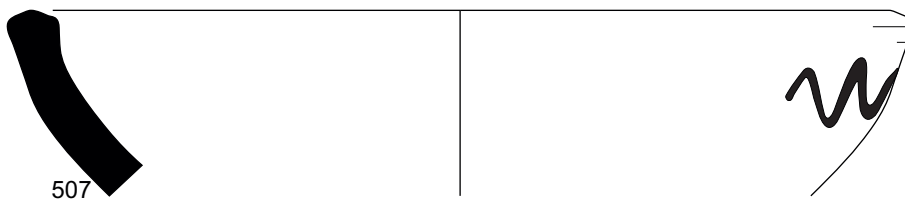
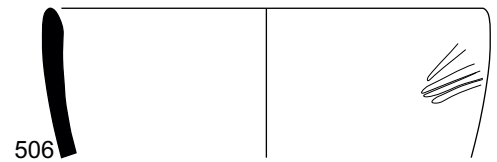
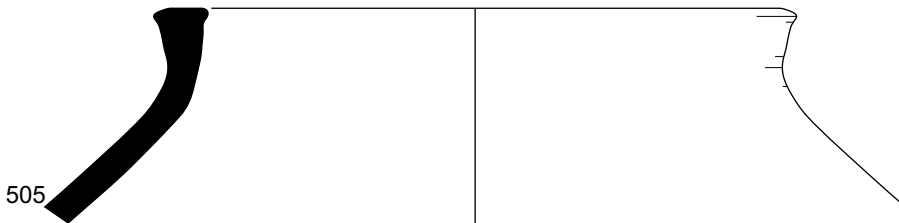
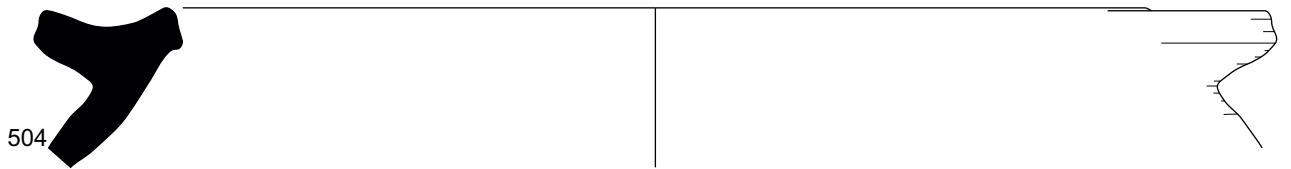
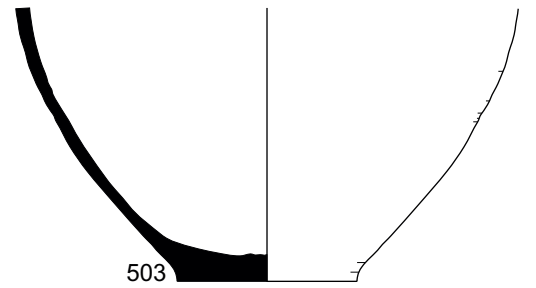
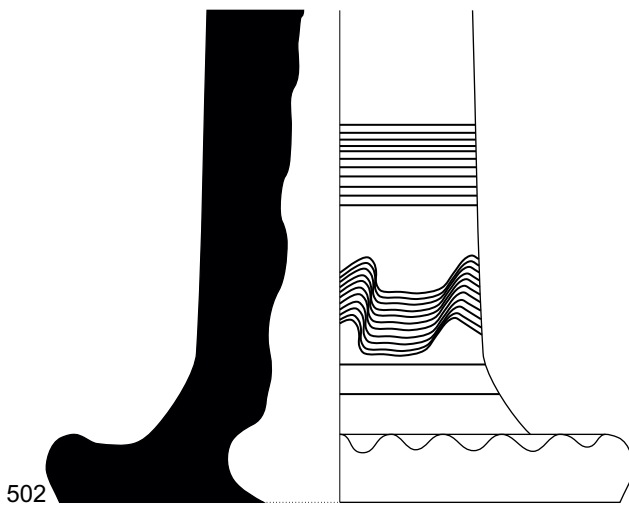
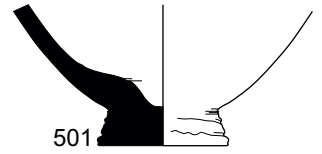
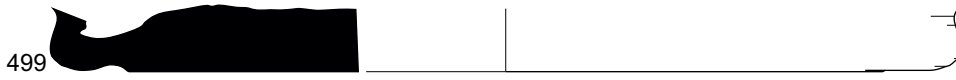
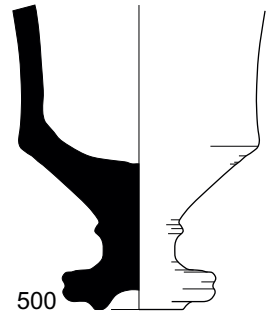
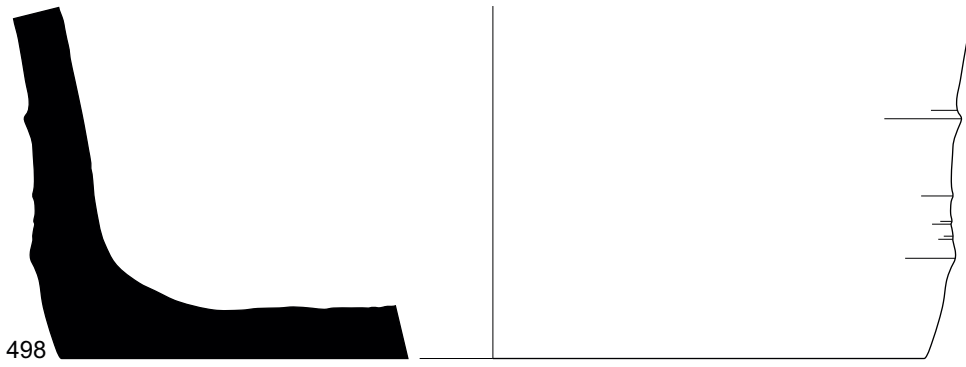

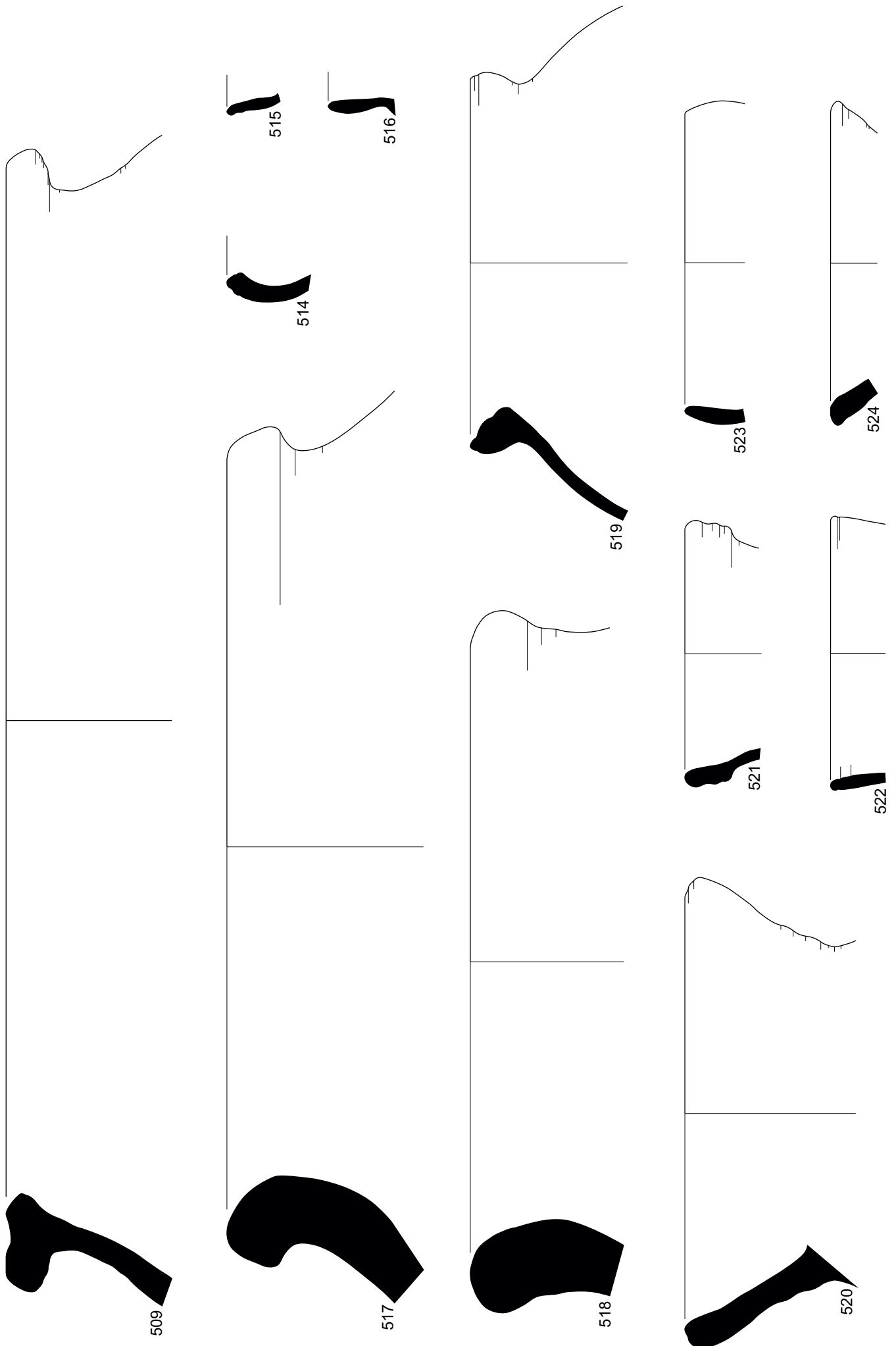

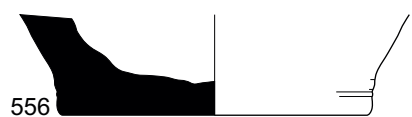
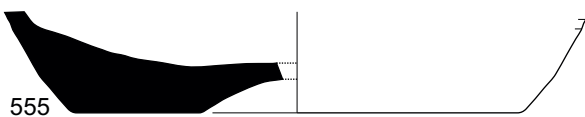
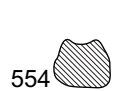
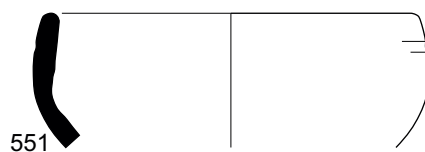
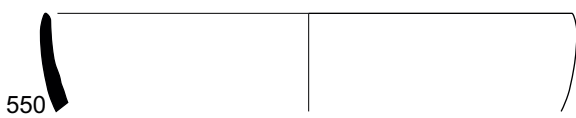
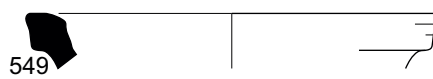
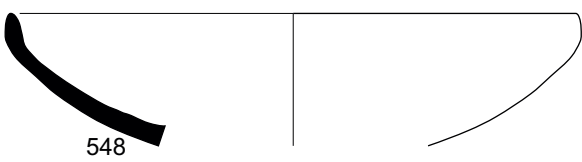
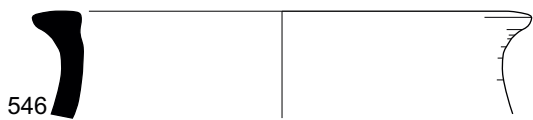
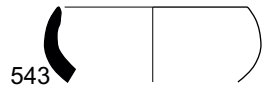
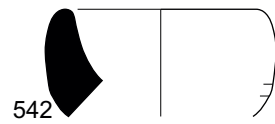
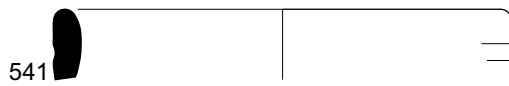
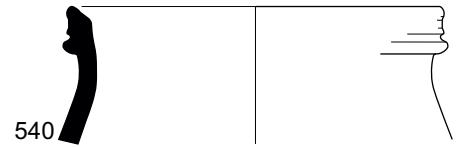
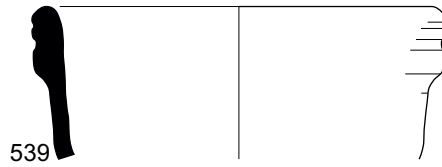
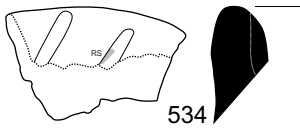
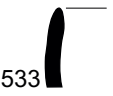
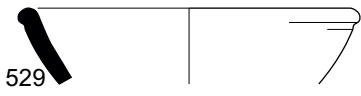
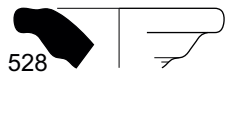
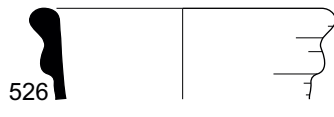

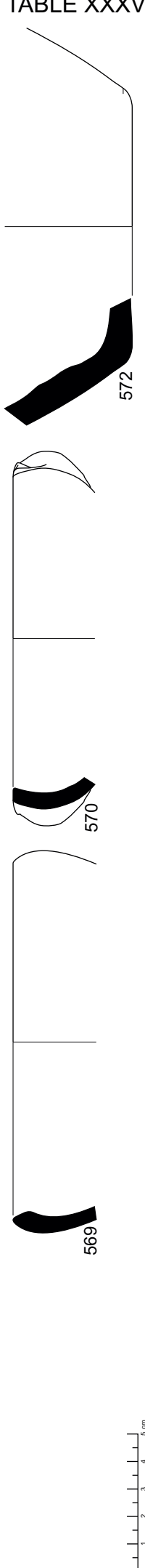
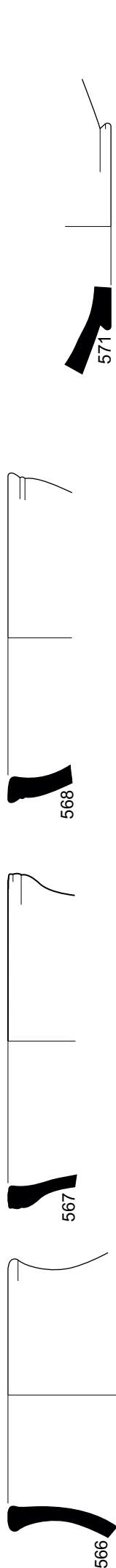
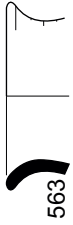
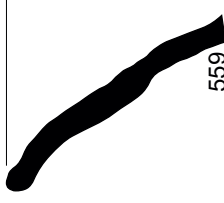
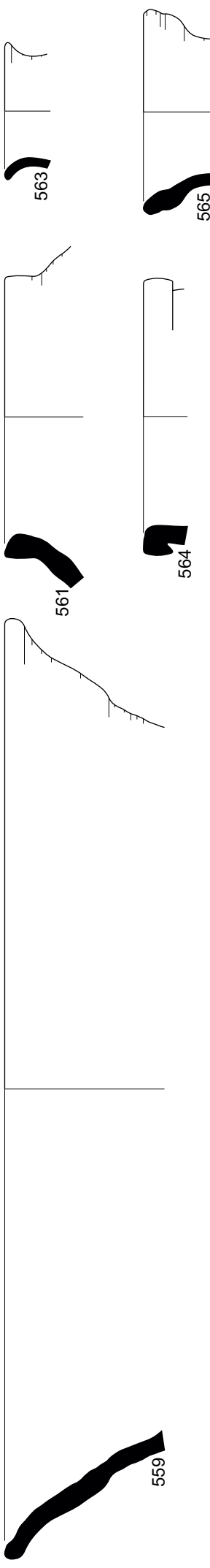
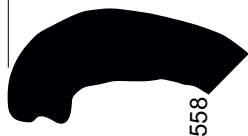
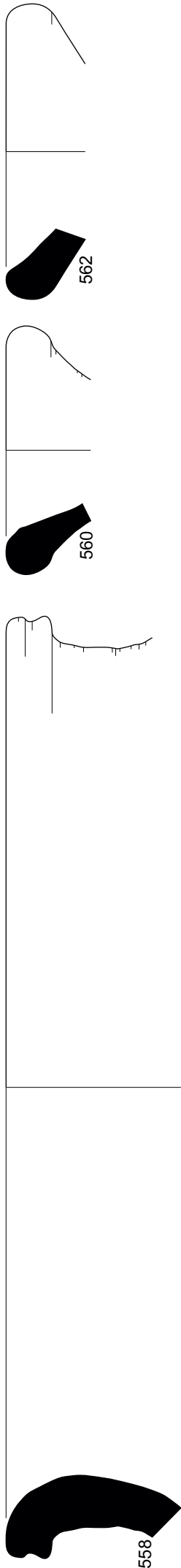
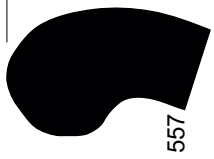
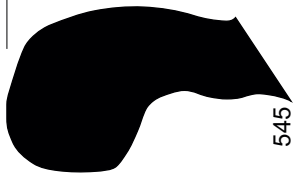
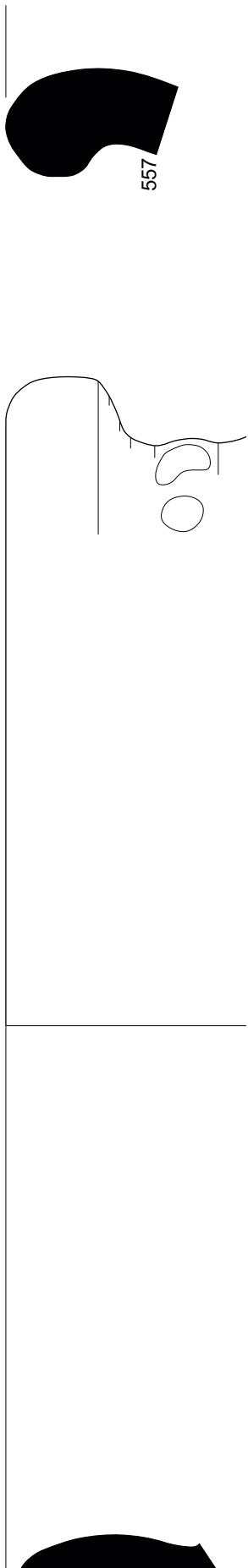

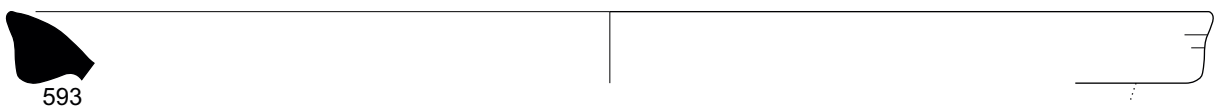
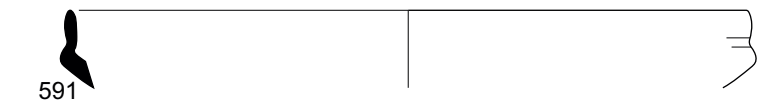
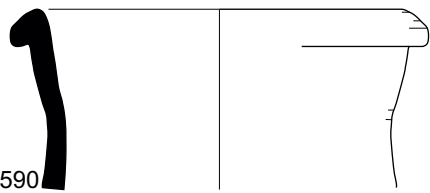
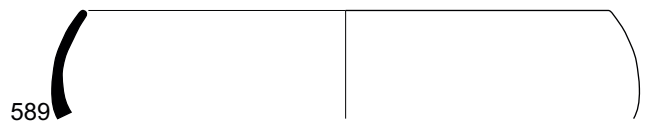
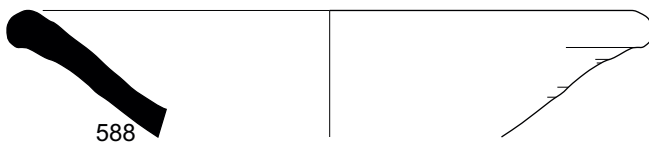
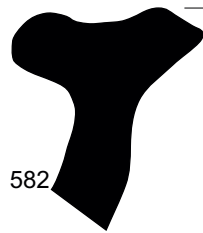
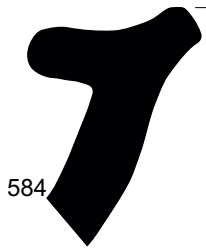
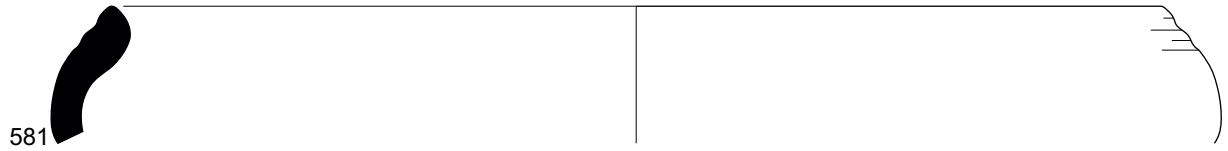
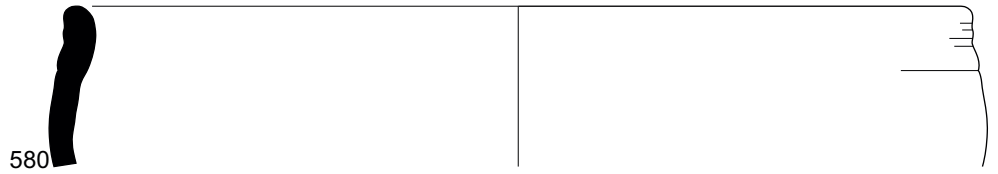
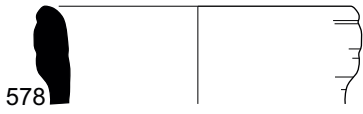
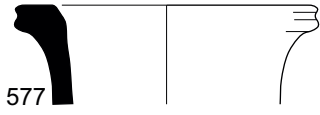
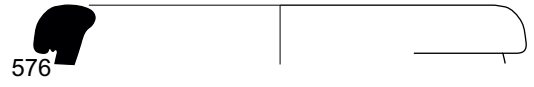
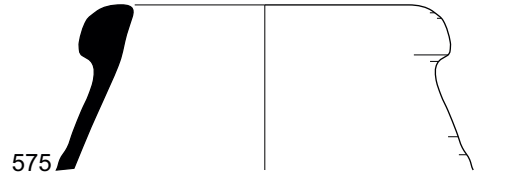
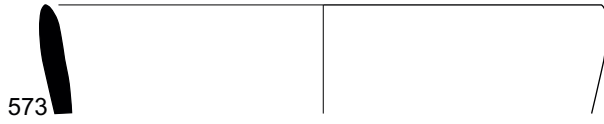

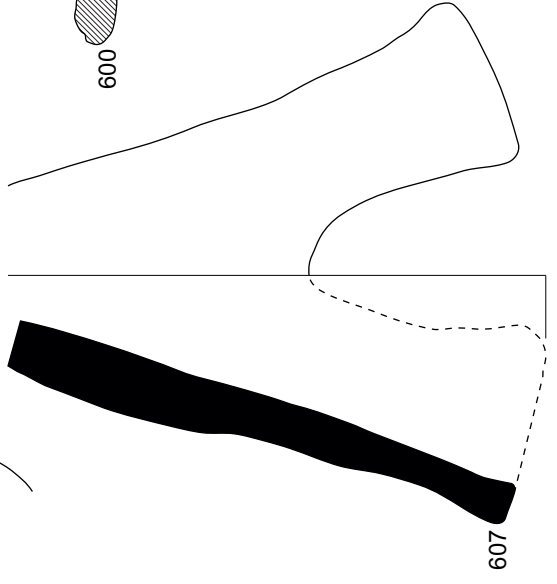
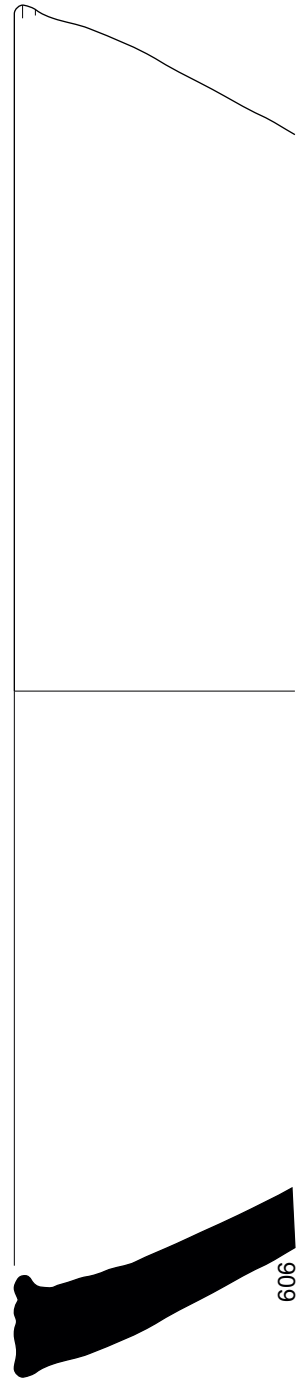
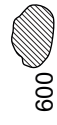
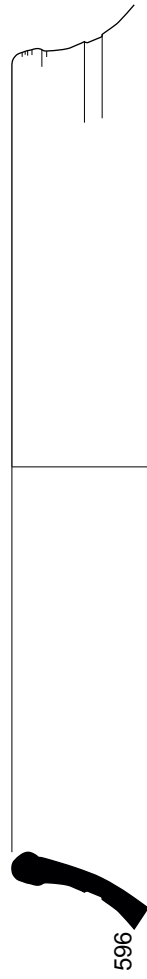
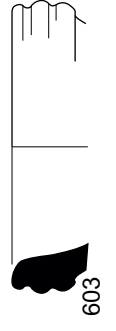
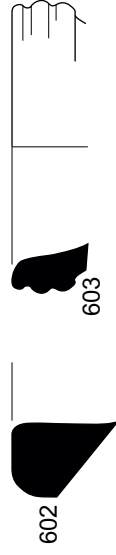
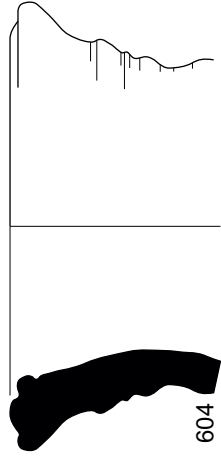
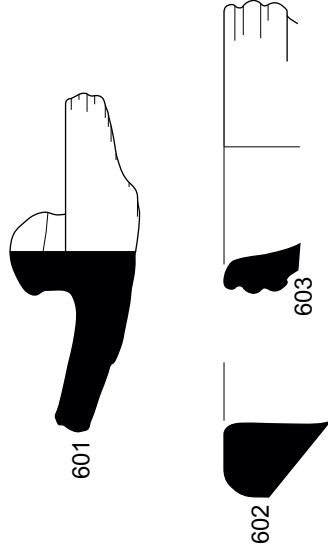
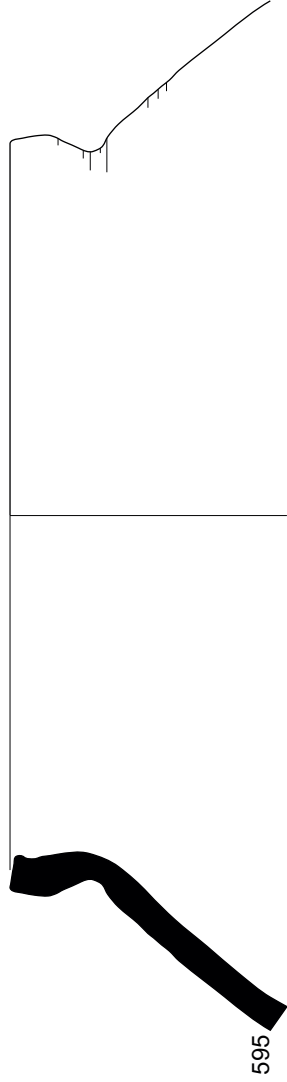
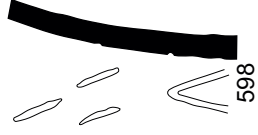
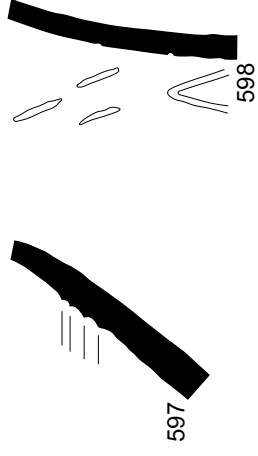
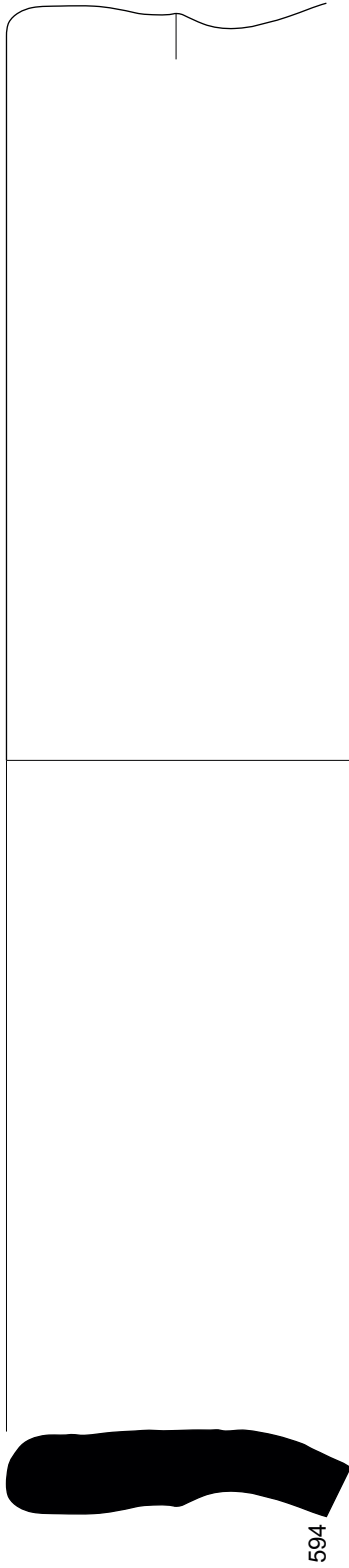

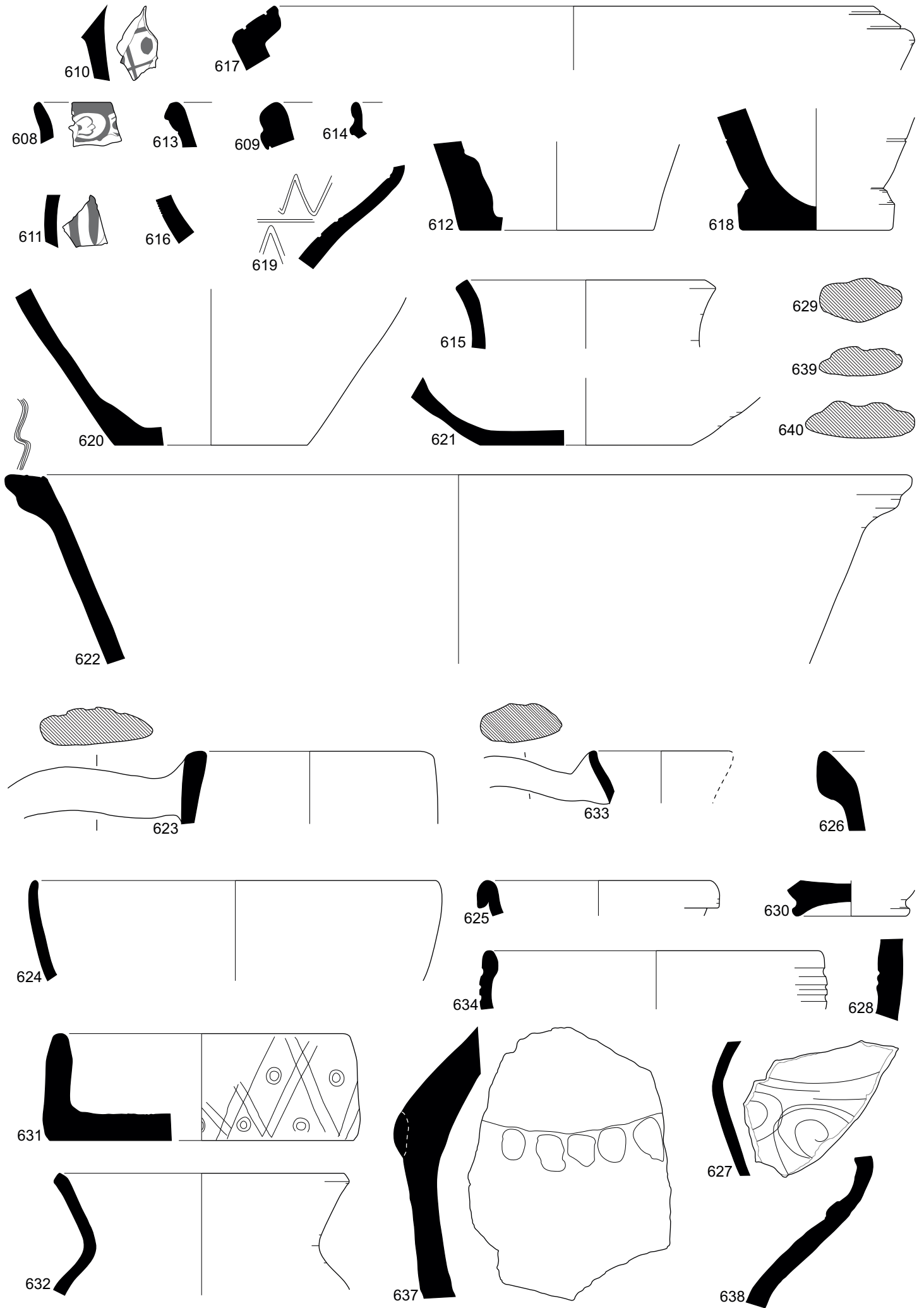



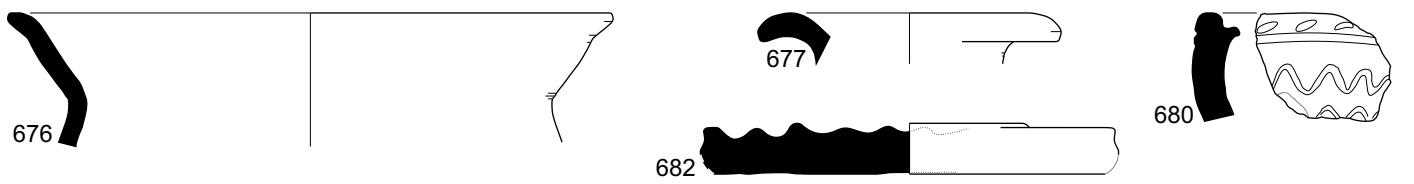
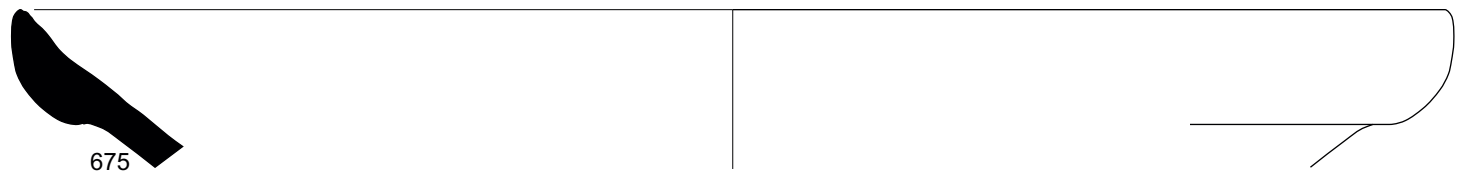
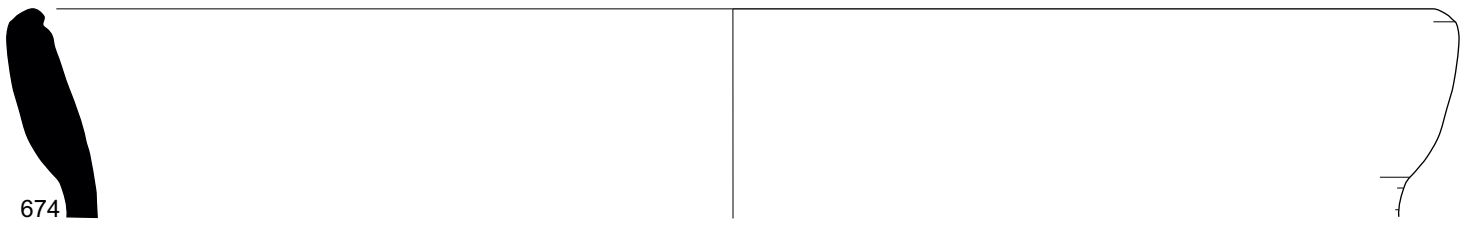
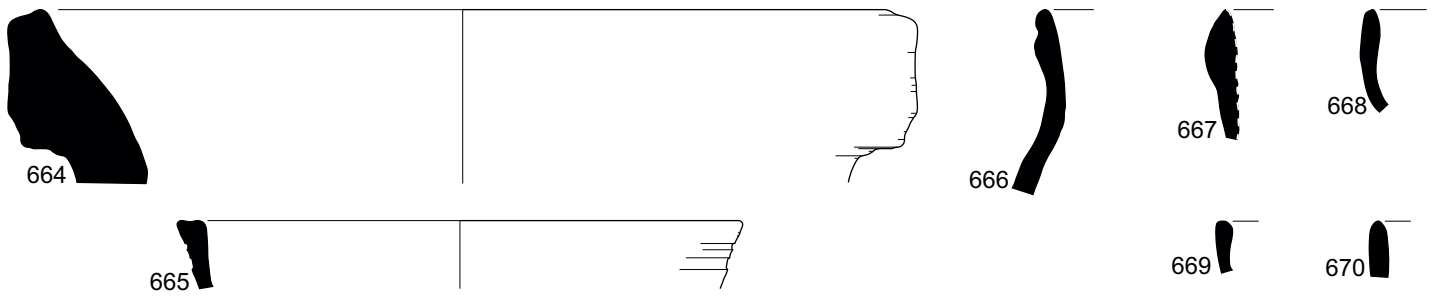
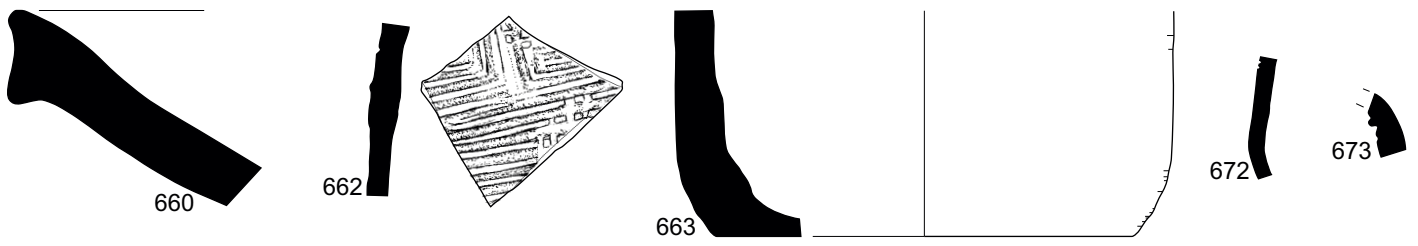
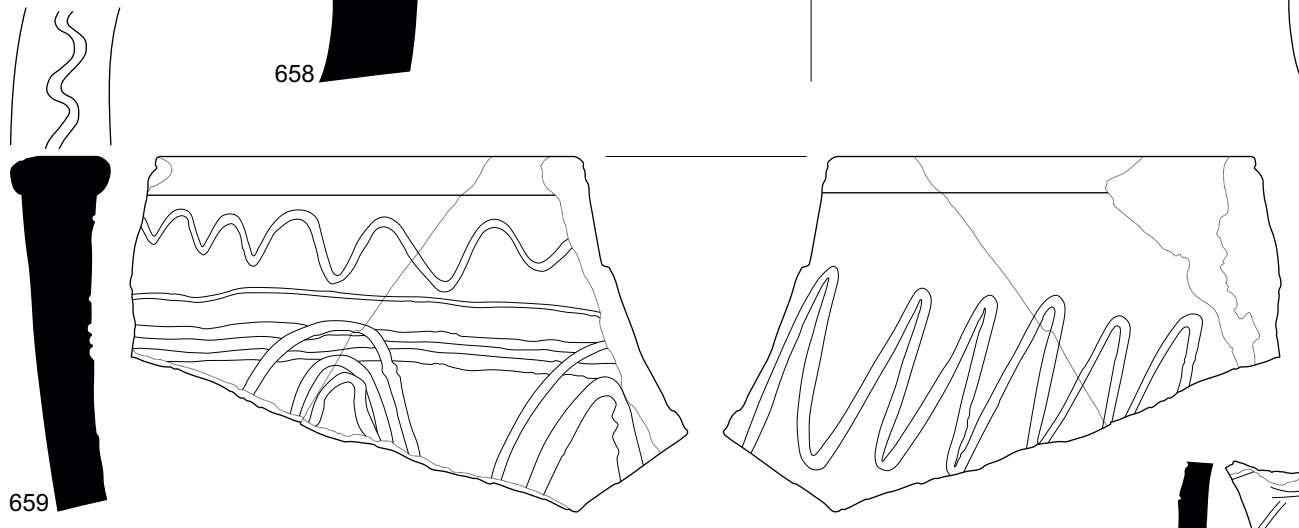
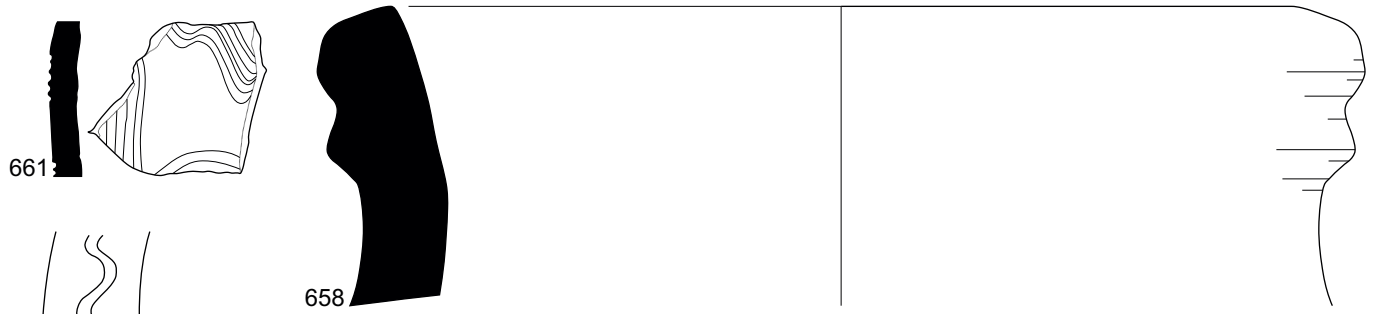

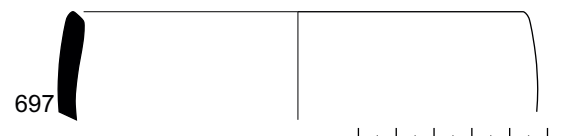
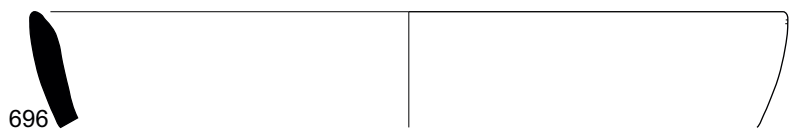
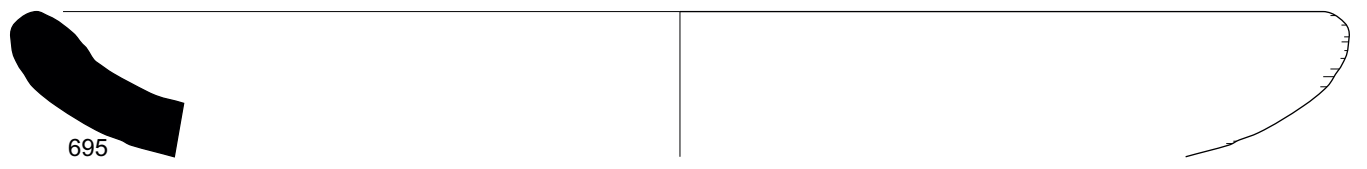
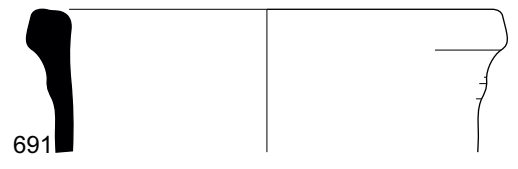
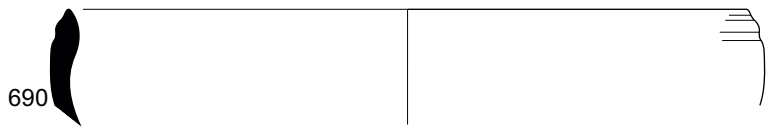
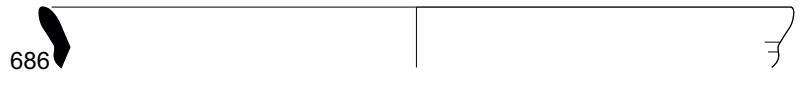
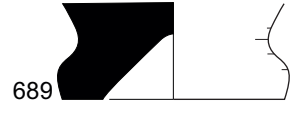
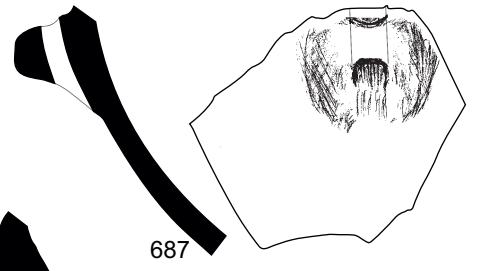
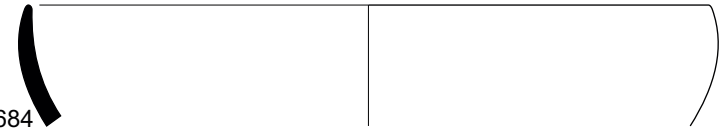
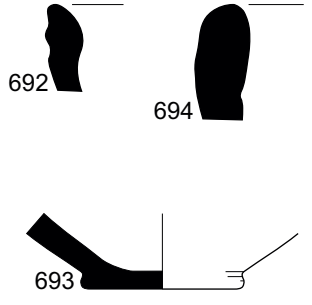
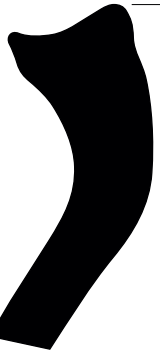
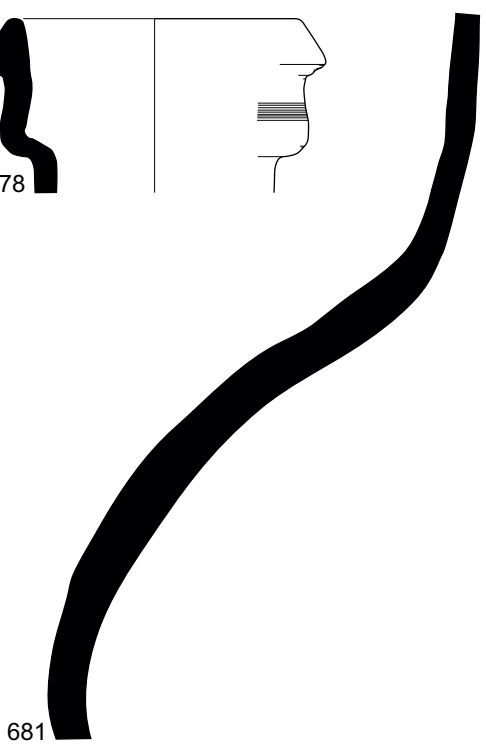
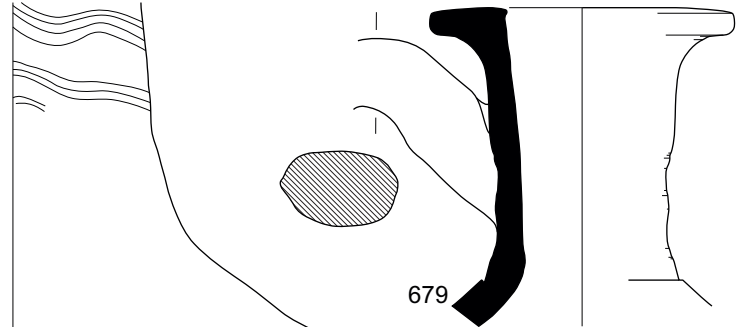
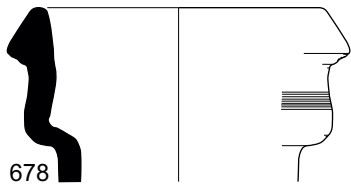



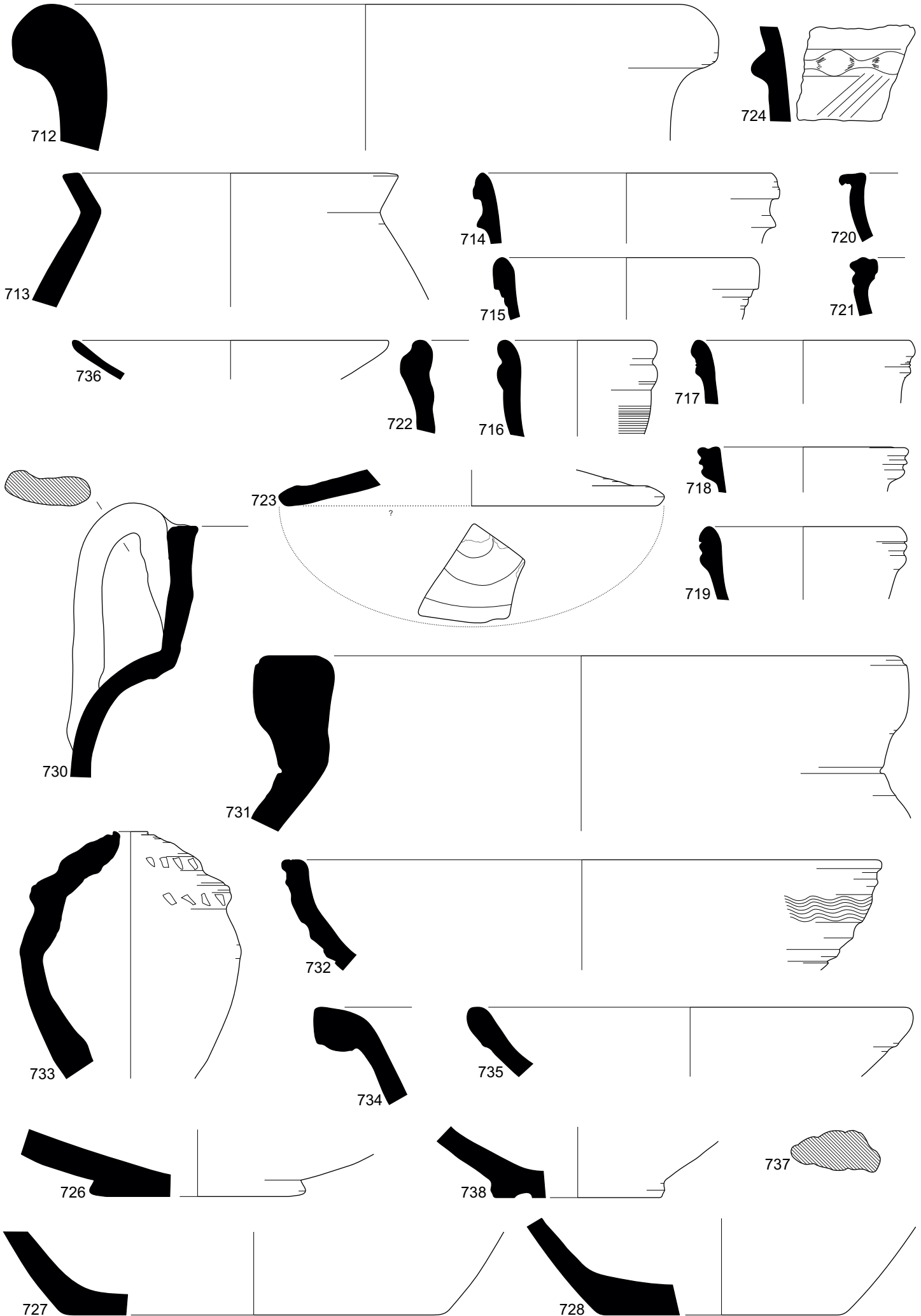

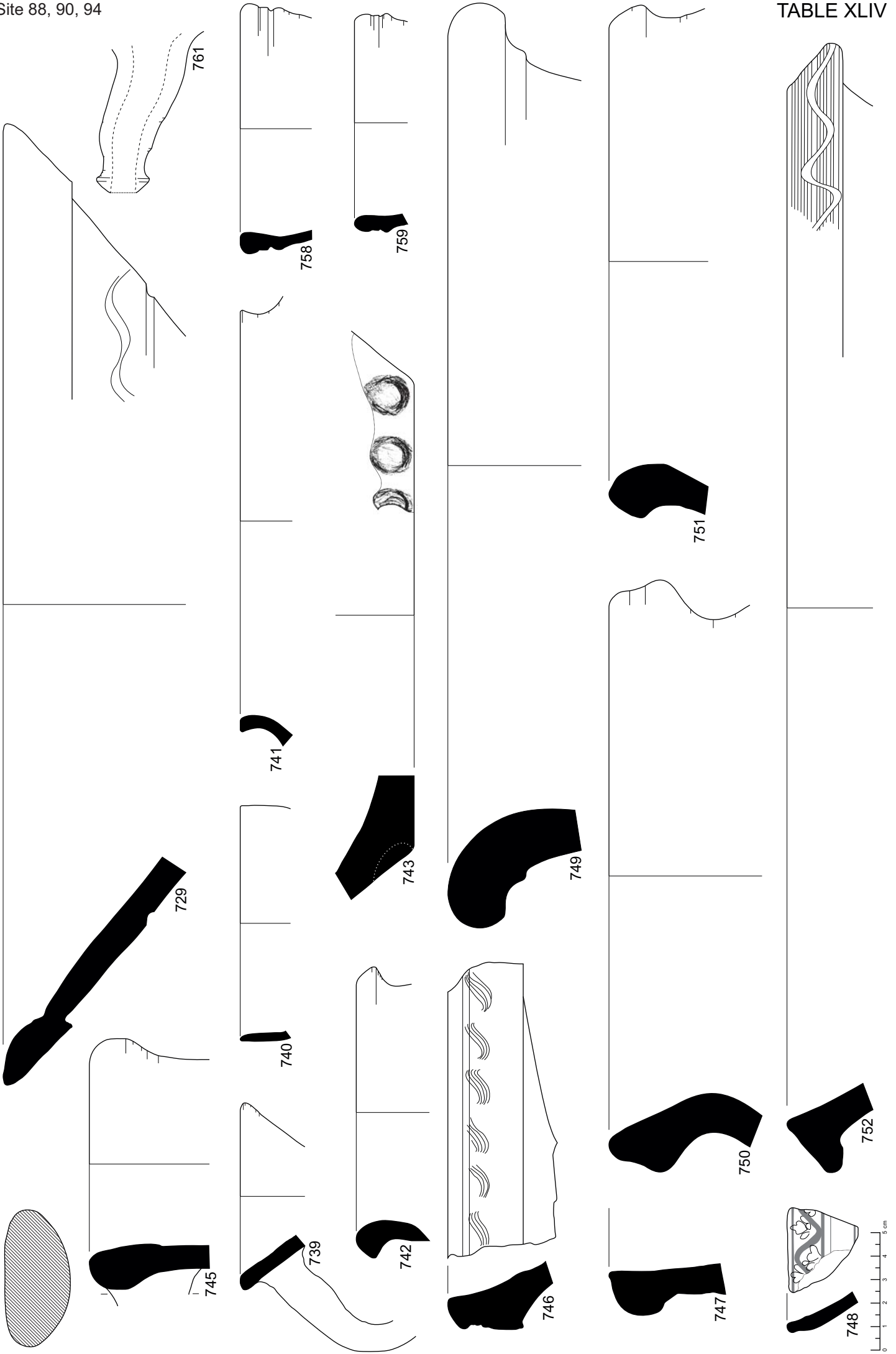

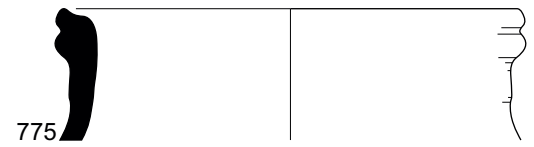
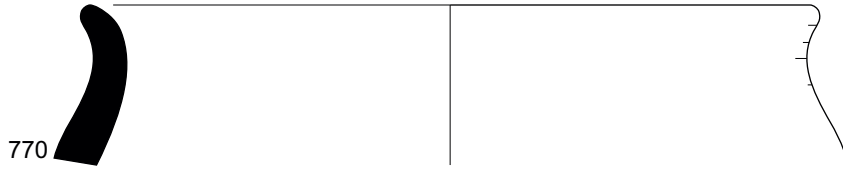
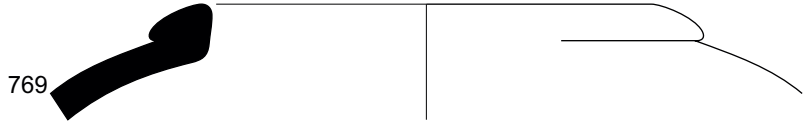
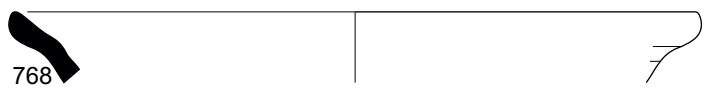
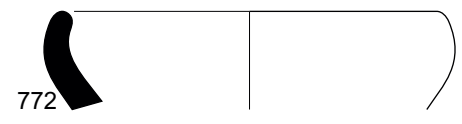
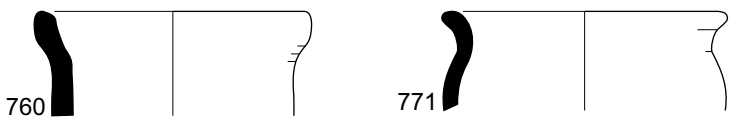
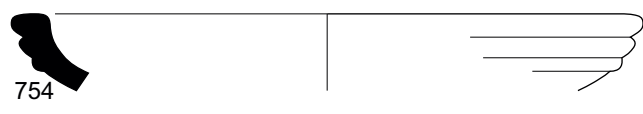
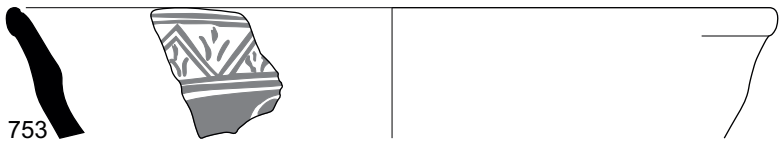

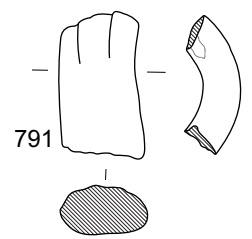
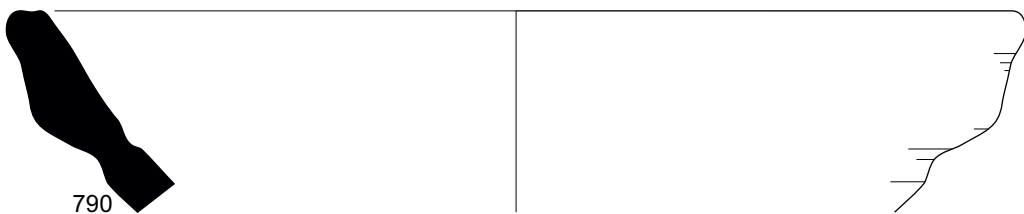
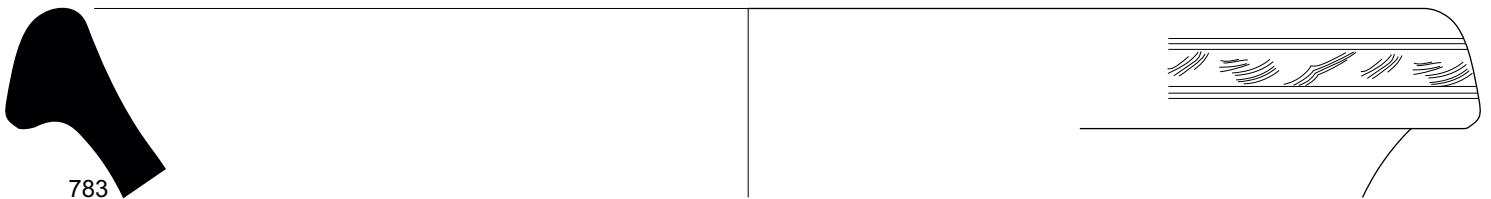
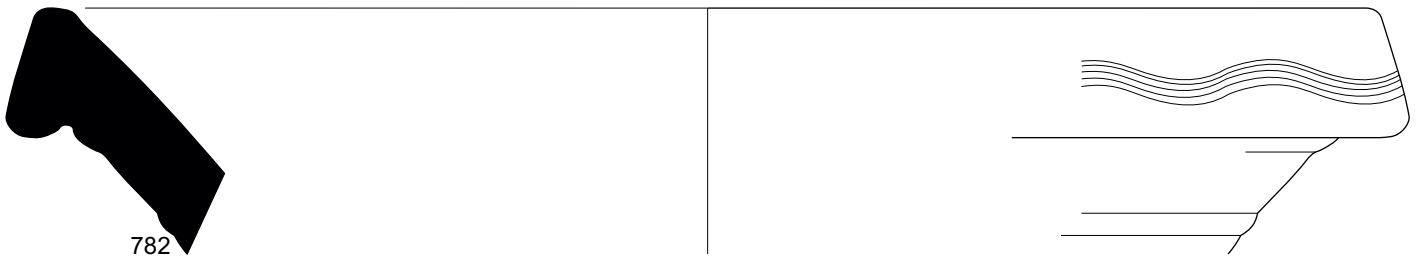
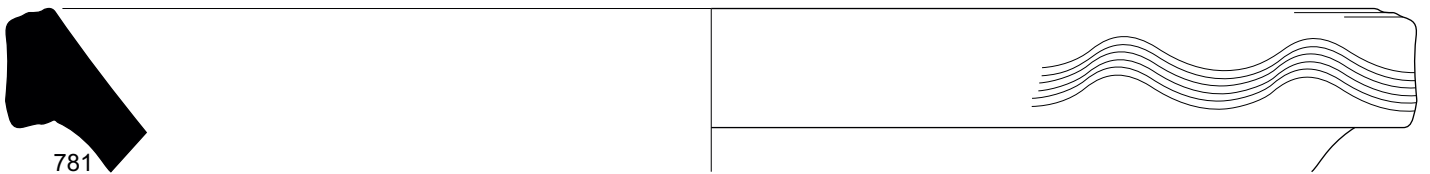
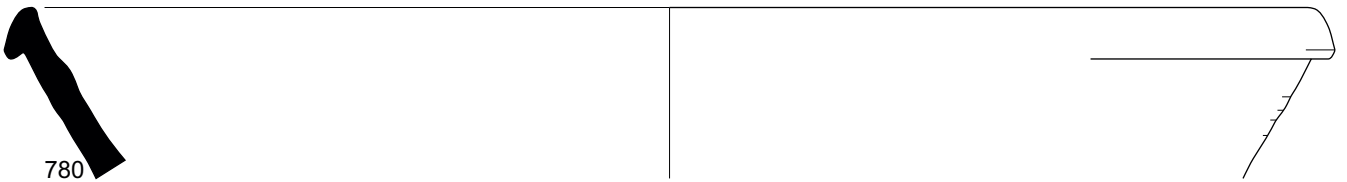
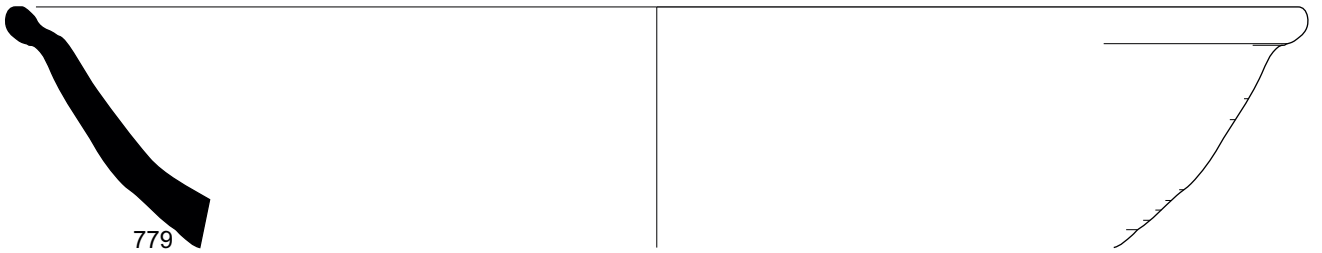
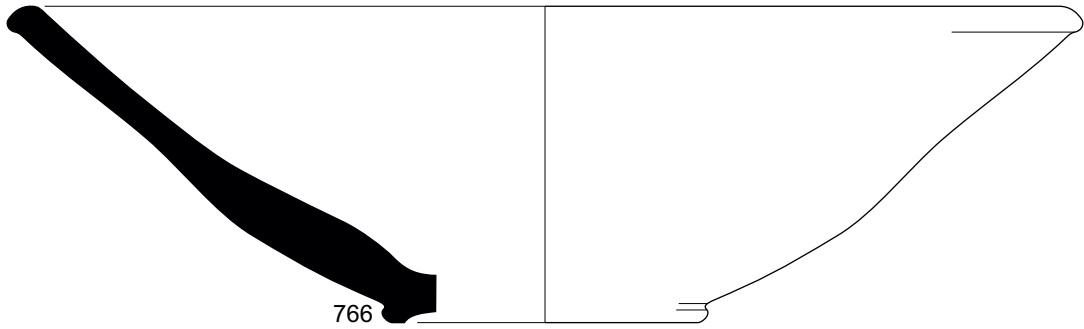

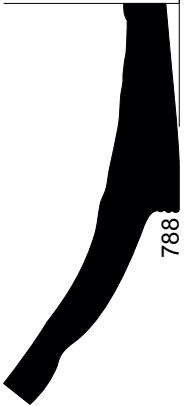
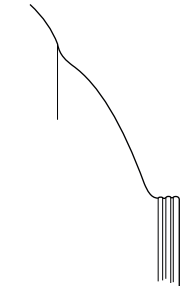
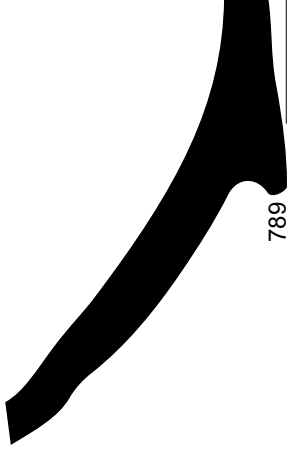
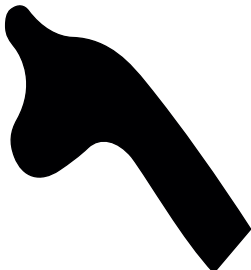
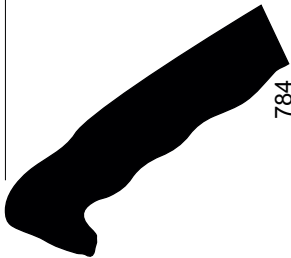
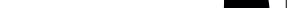
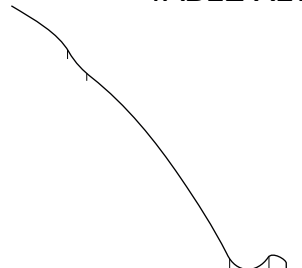
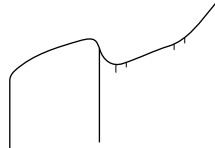
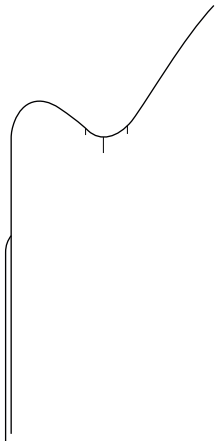
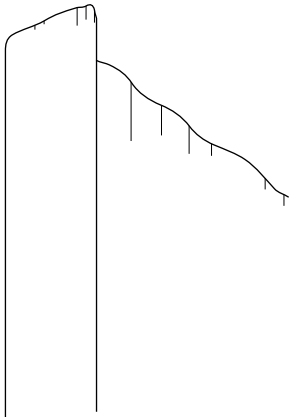

784

785

787

786

789

788

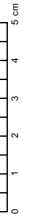

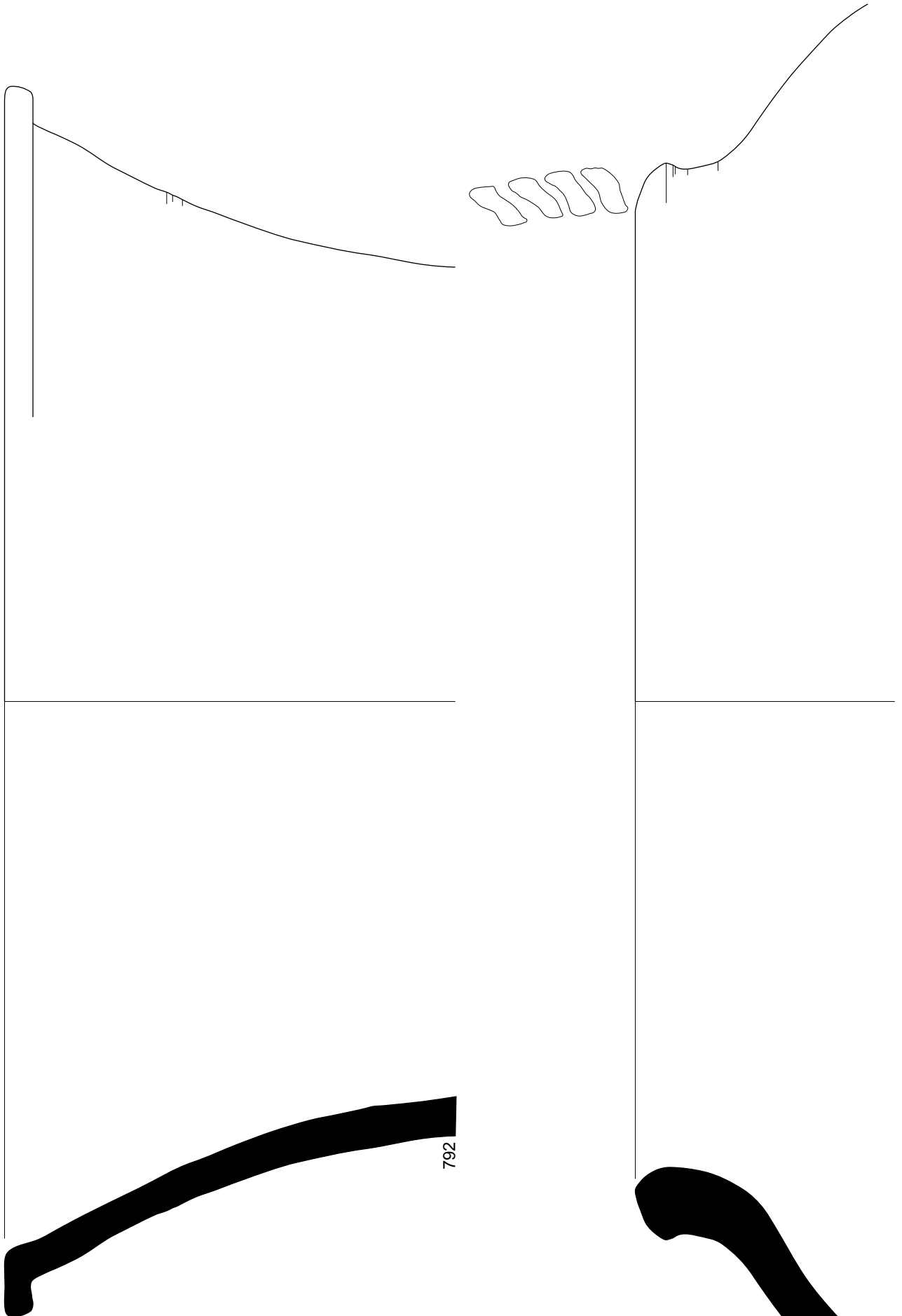

792

793



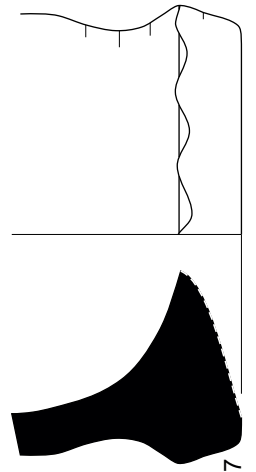
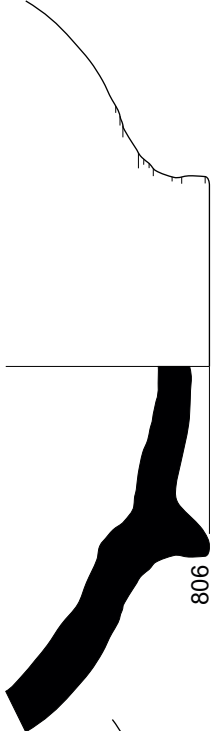
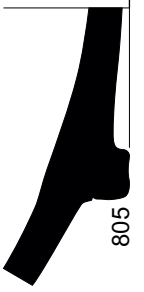
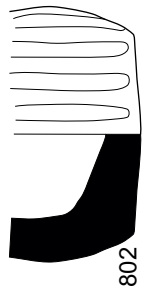
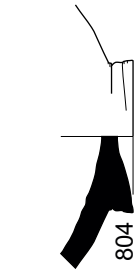
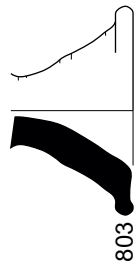
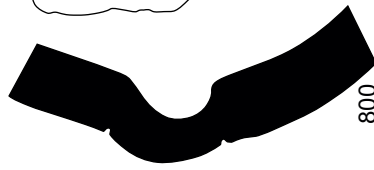
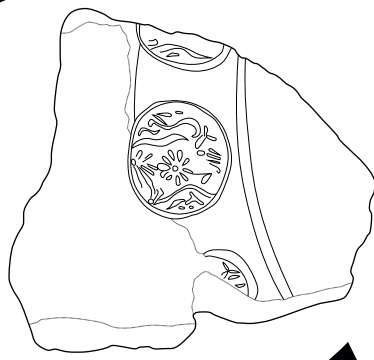
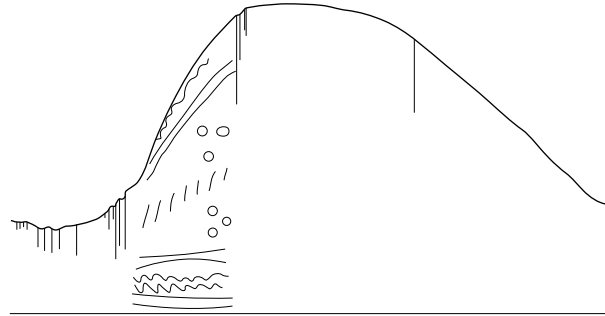
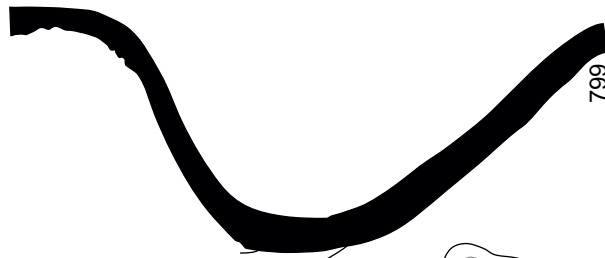
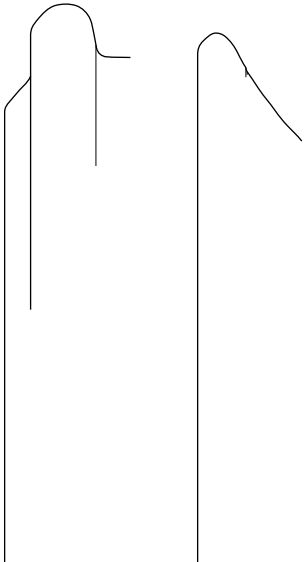
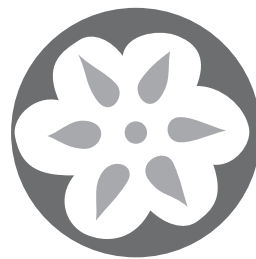
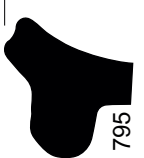
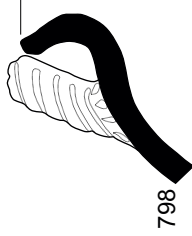
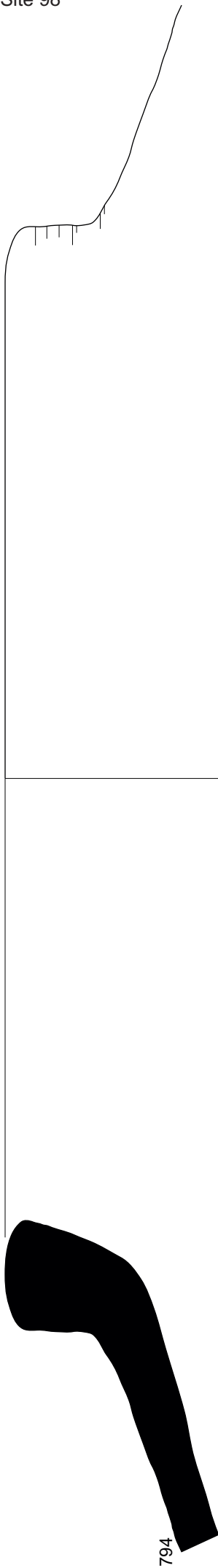

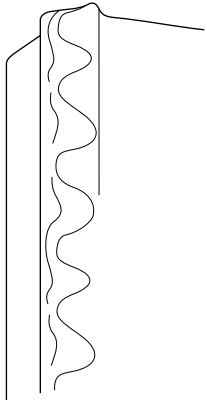

808

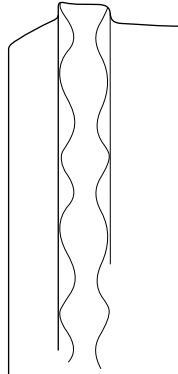

809

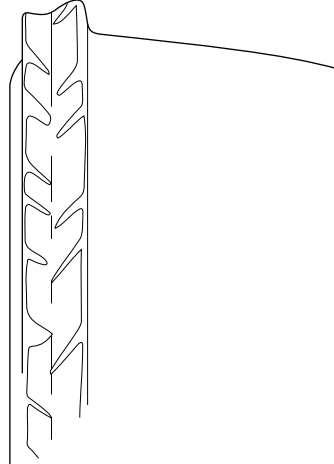

810

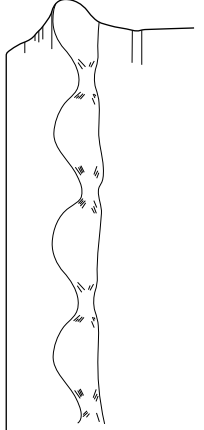

811

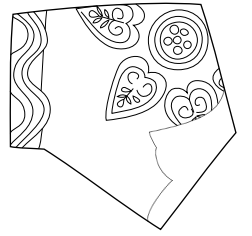

822

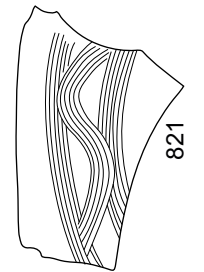

821



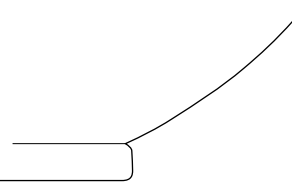
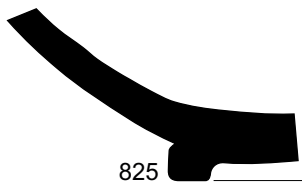
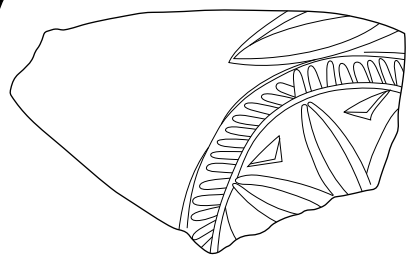
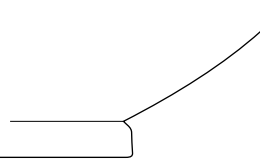
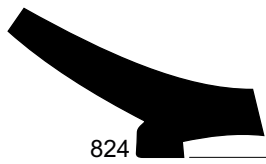
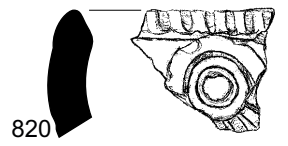
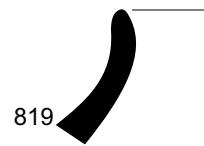
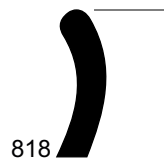
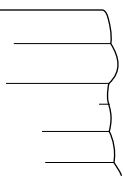
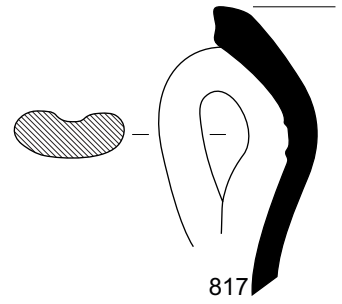
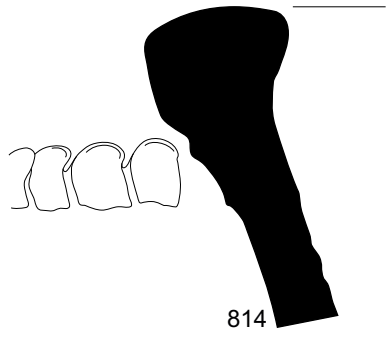
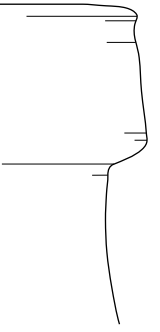
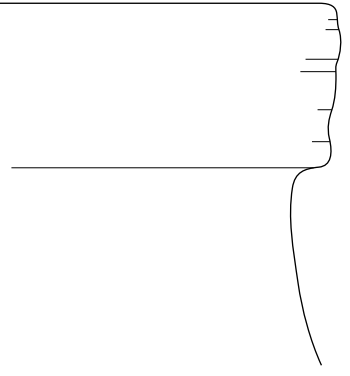
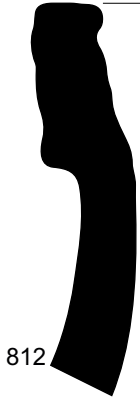

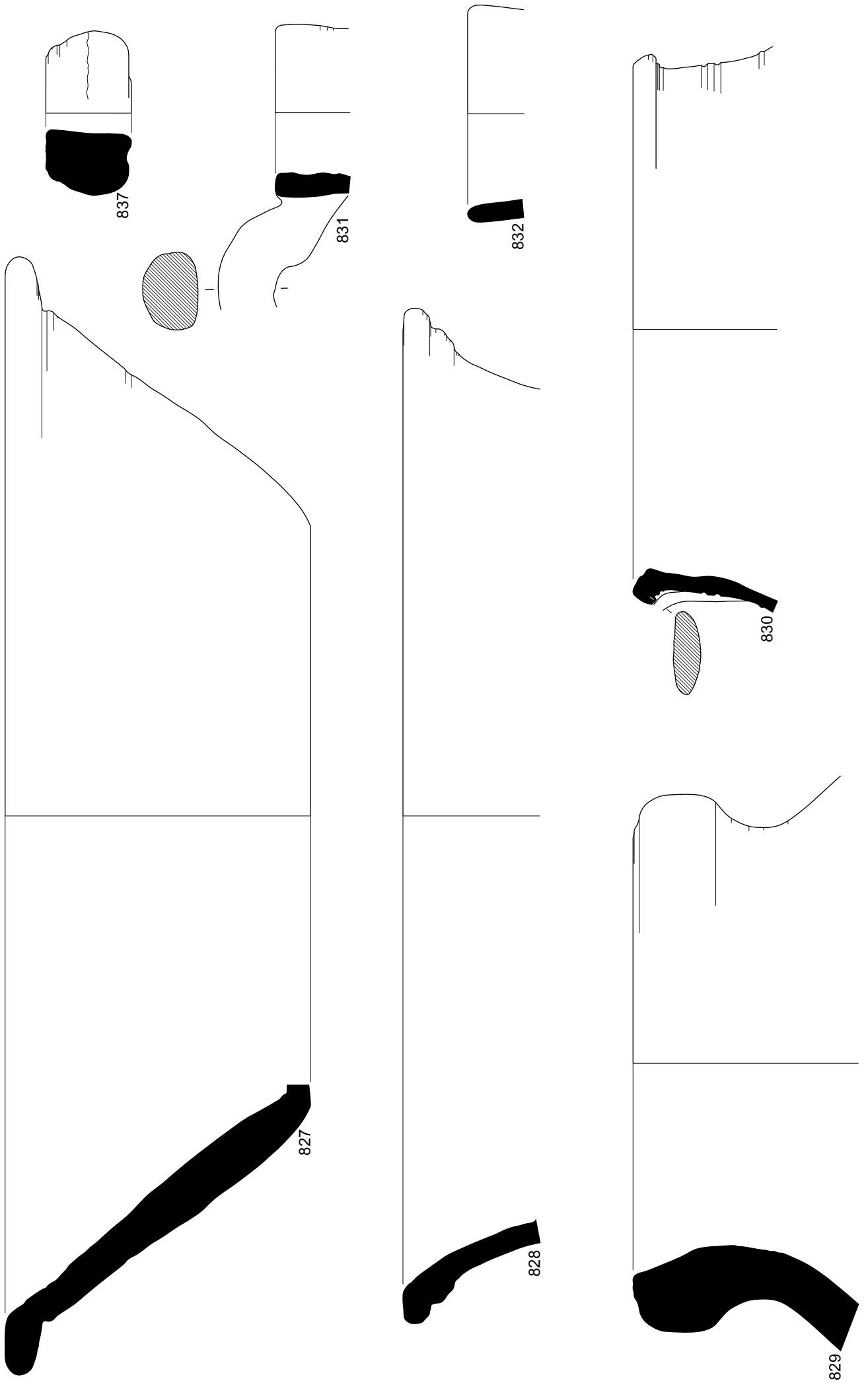

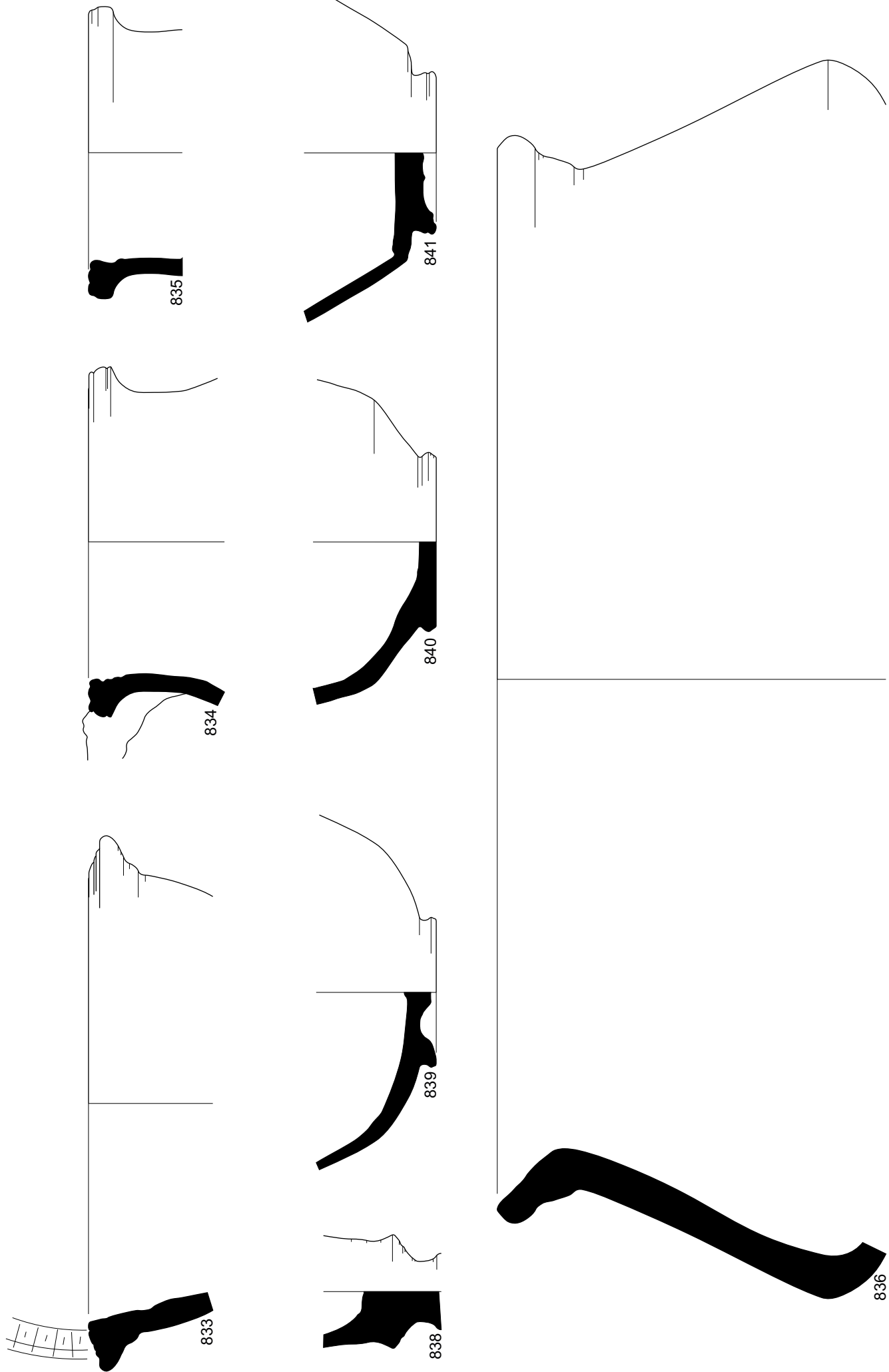

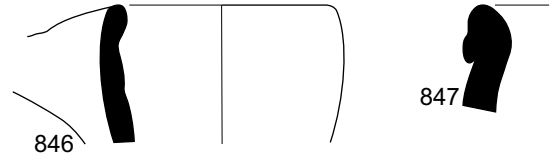
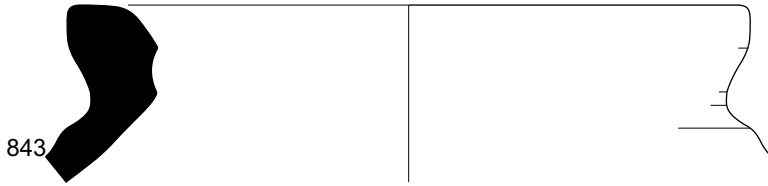
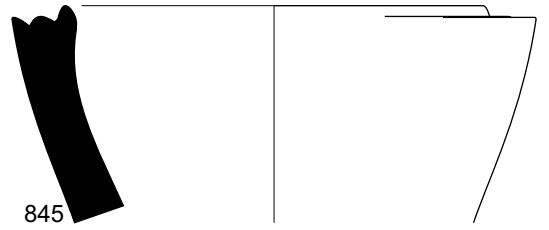
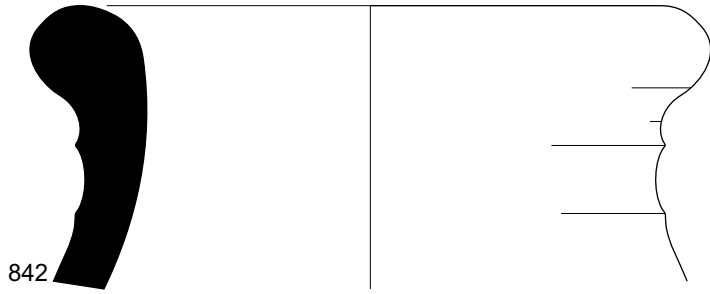

847

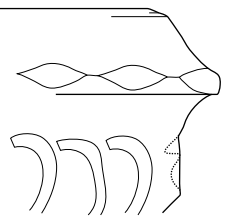
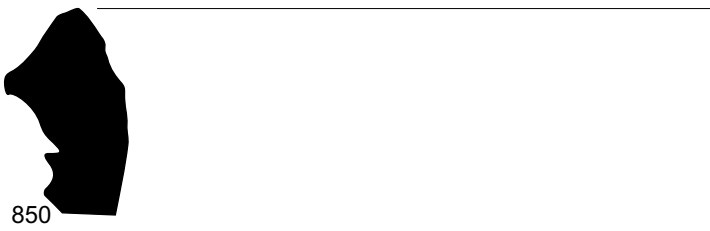
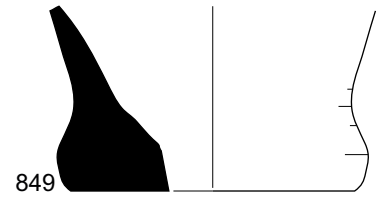
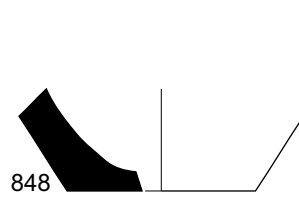
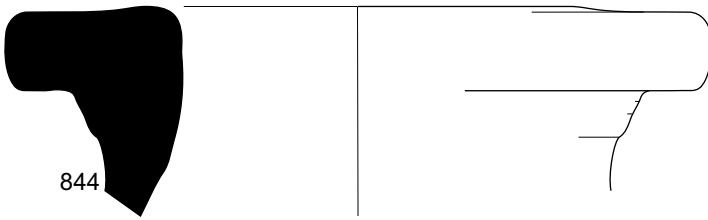

850

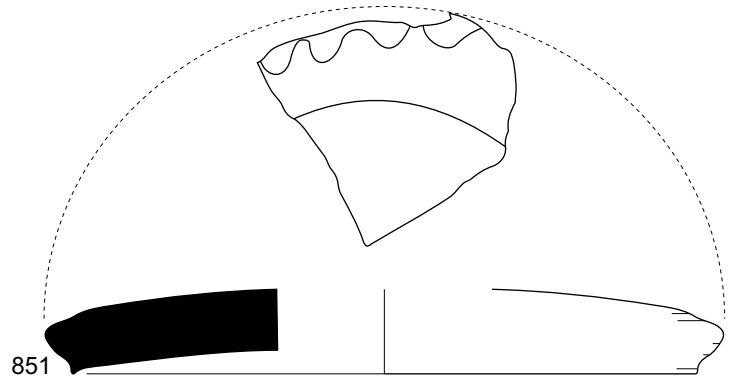
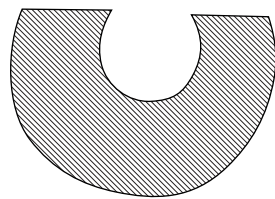
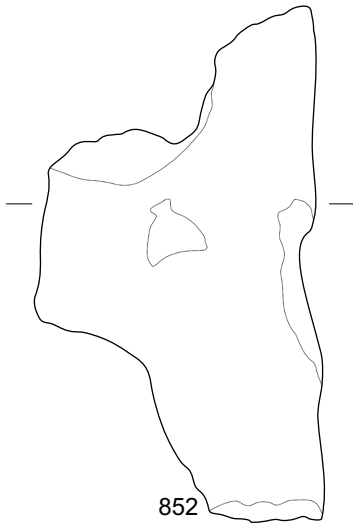

851

852

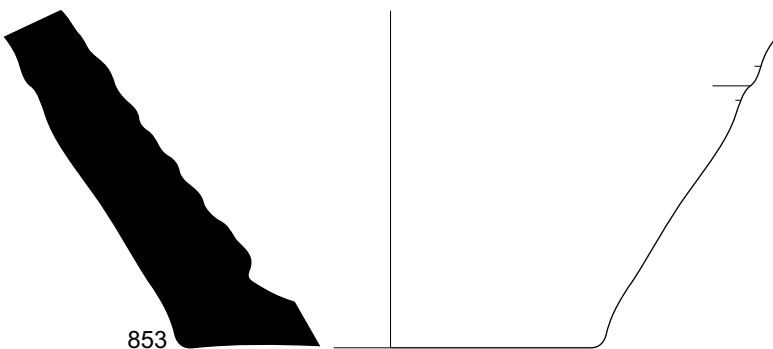

853



854

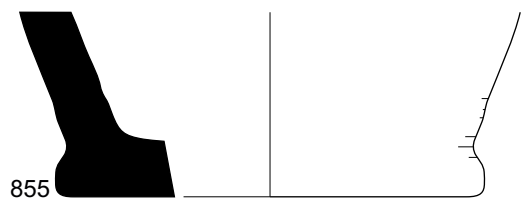

855

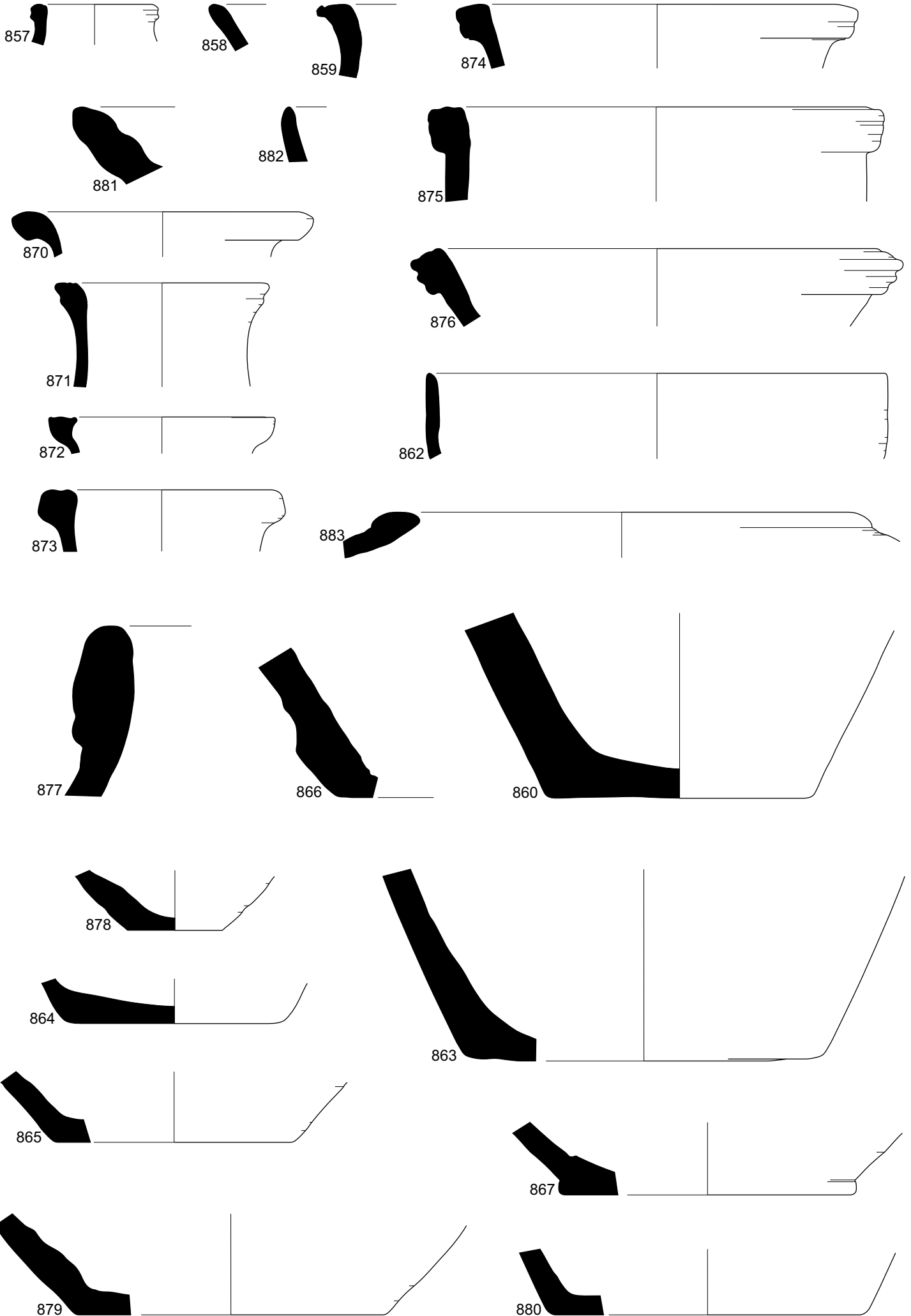

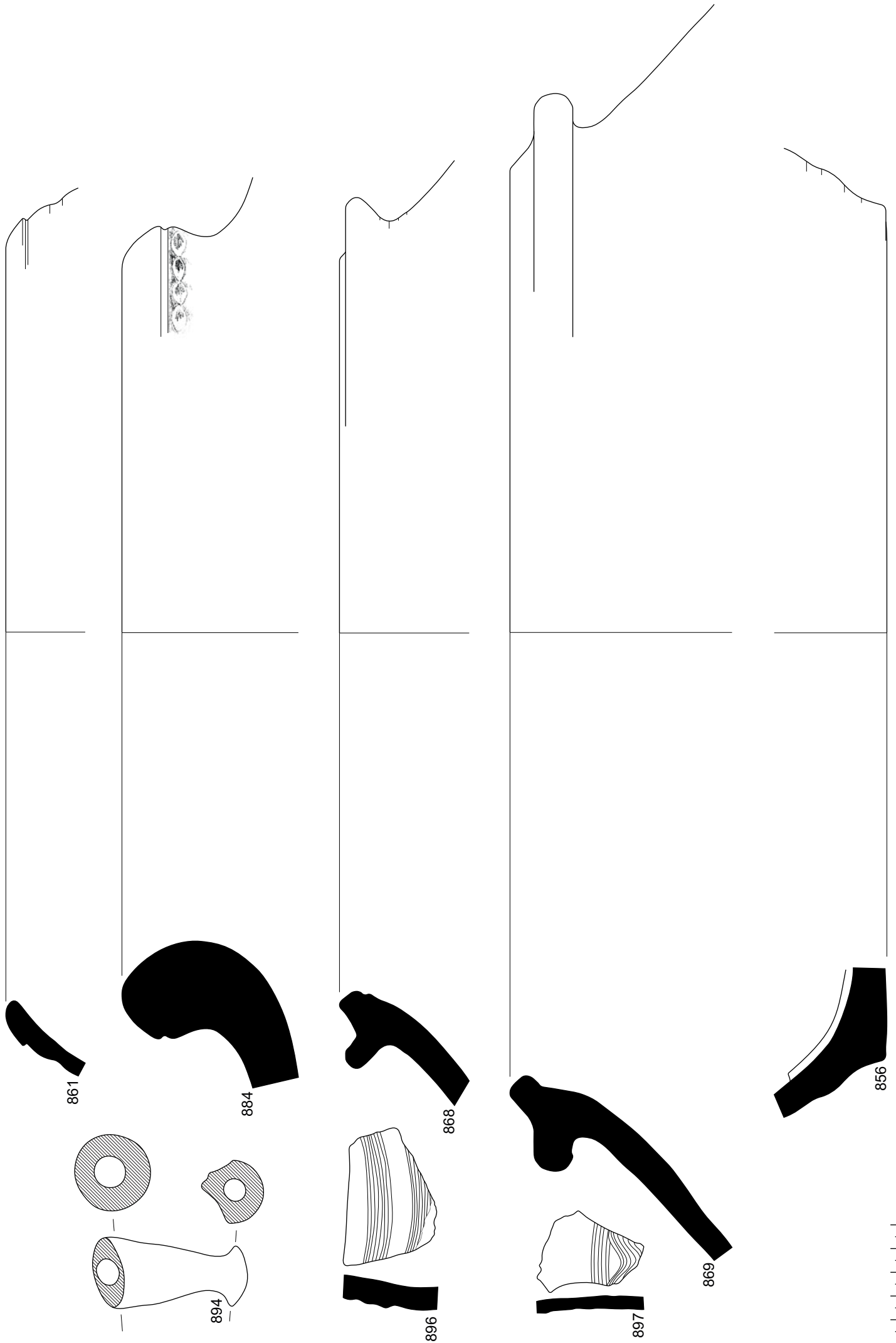



891

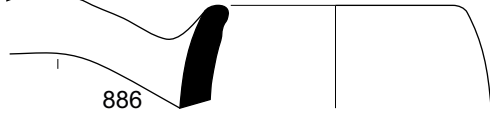

886

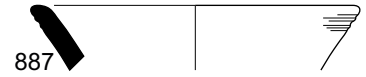

887



885



898

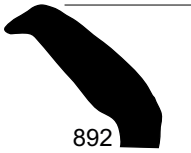

892



899



900

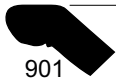

901

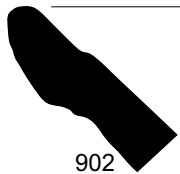

902

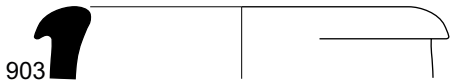

903

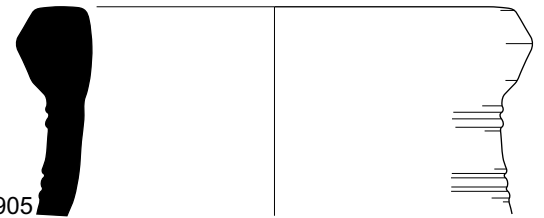

905

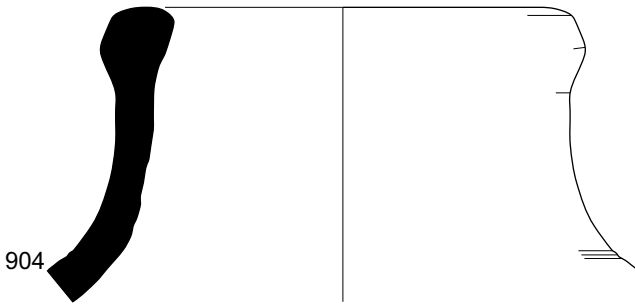

904

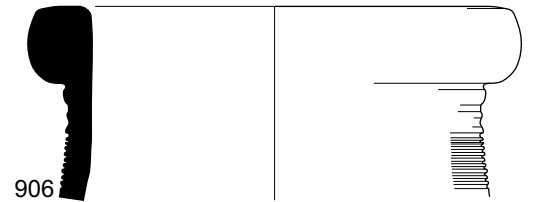

906



888



889

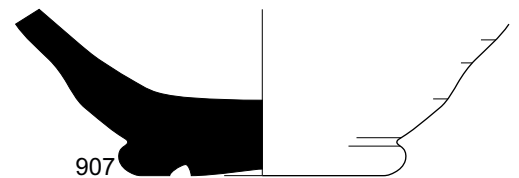

907

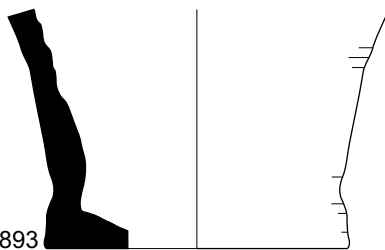

893



890

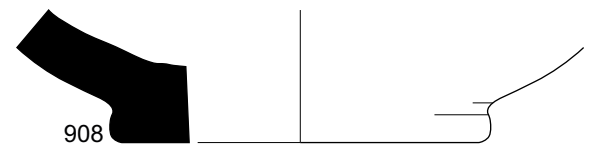

908

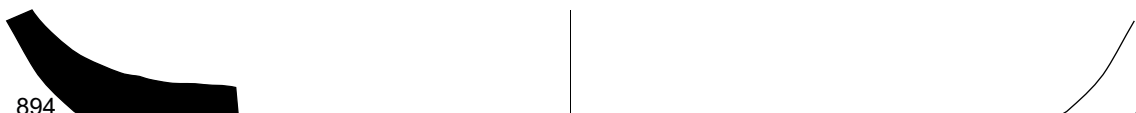

894

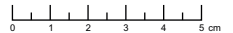

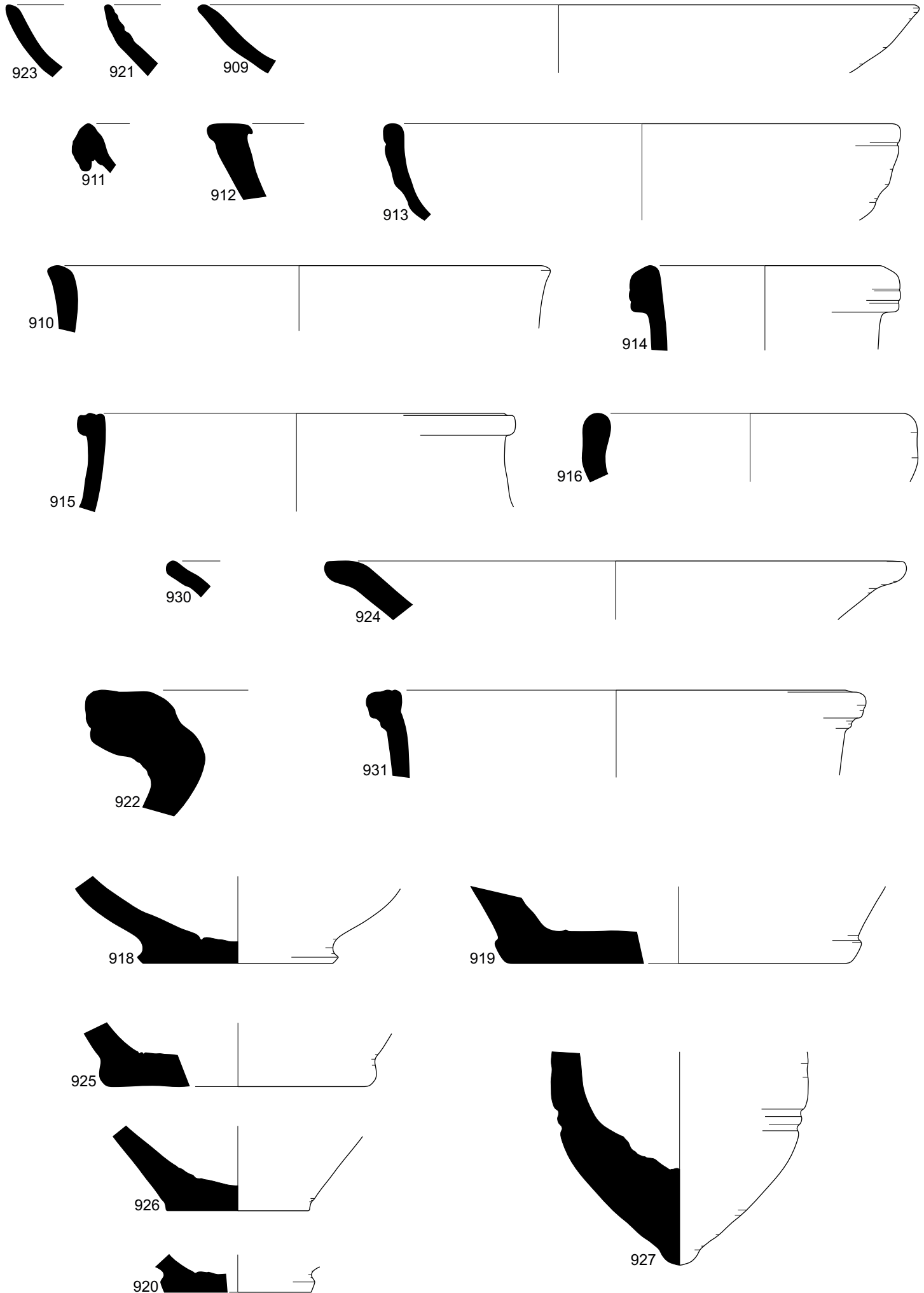

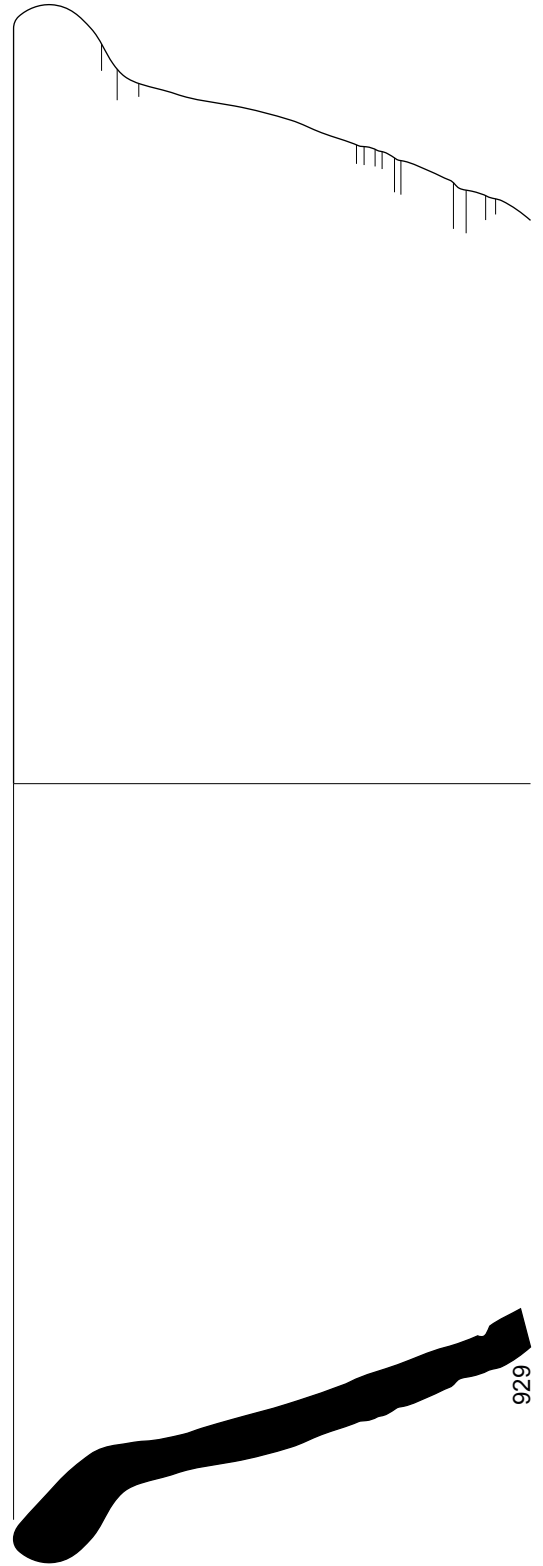
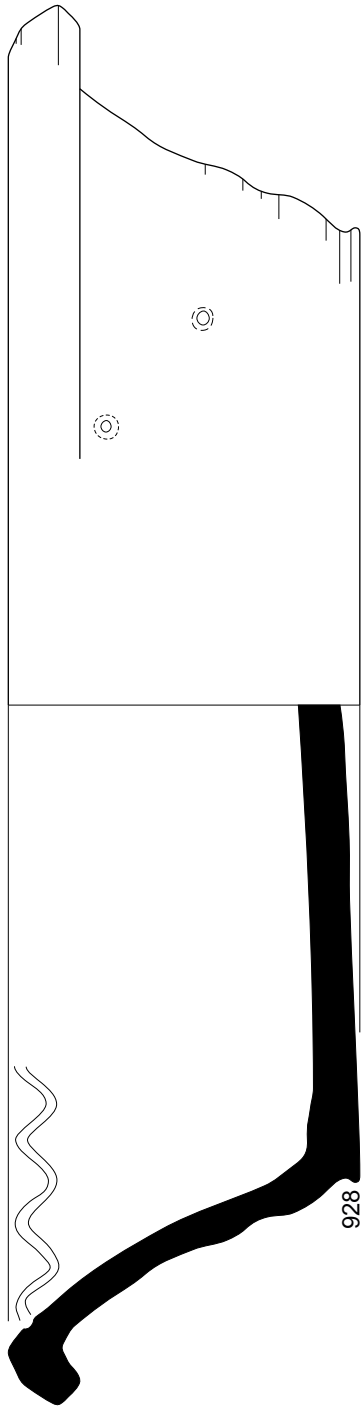
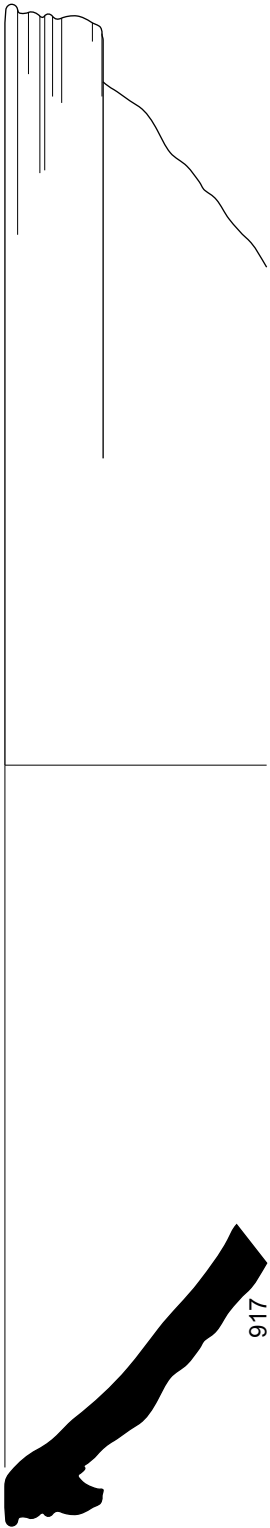



932

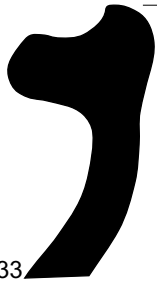
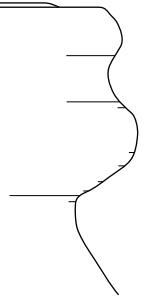

933

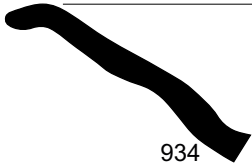
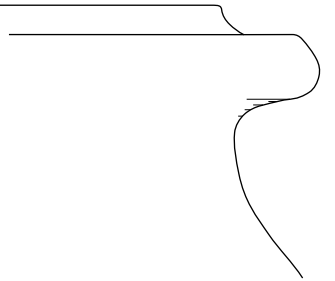

934

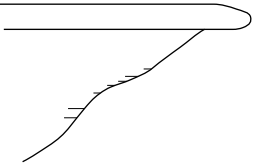

935

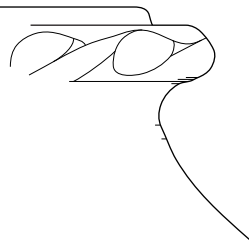

936



937

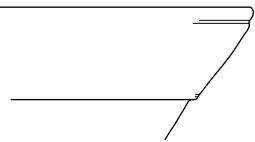

938

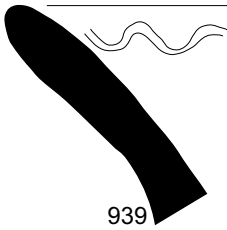
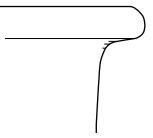

939

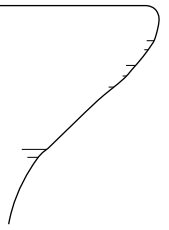

940

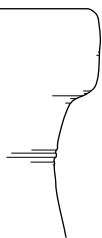

941



942



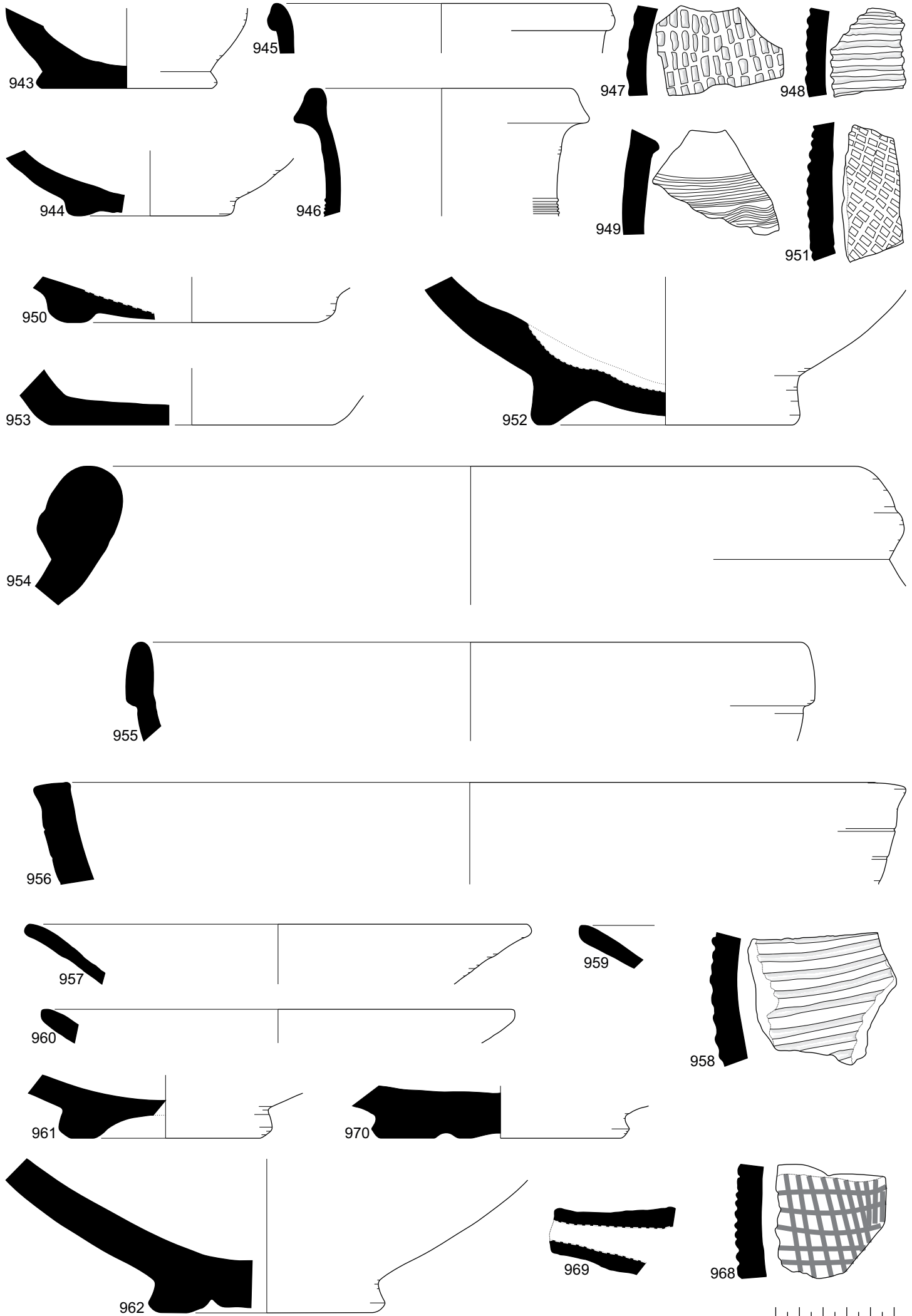

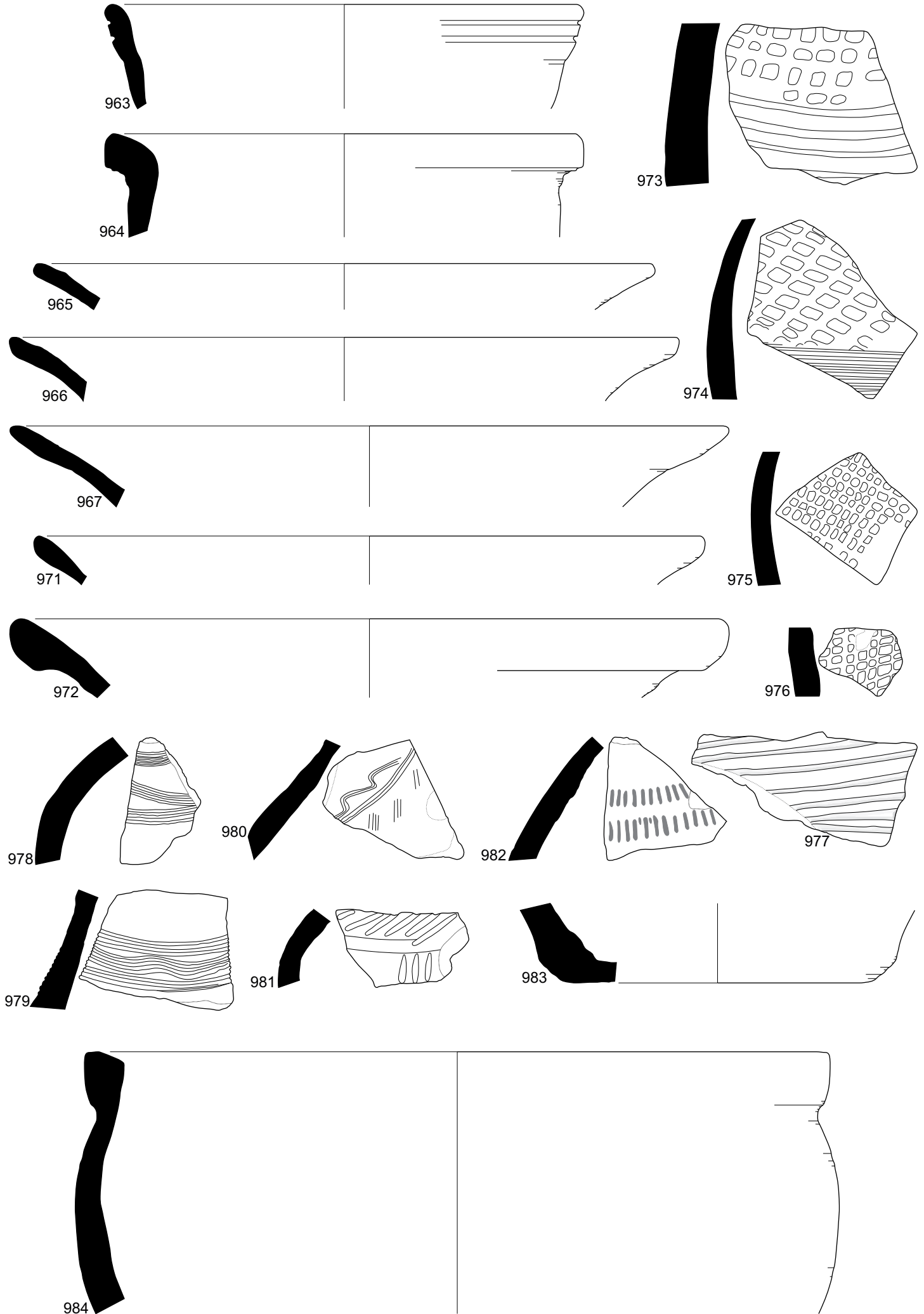

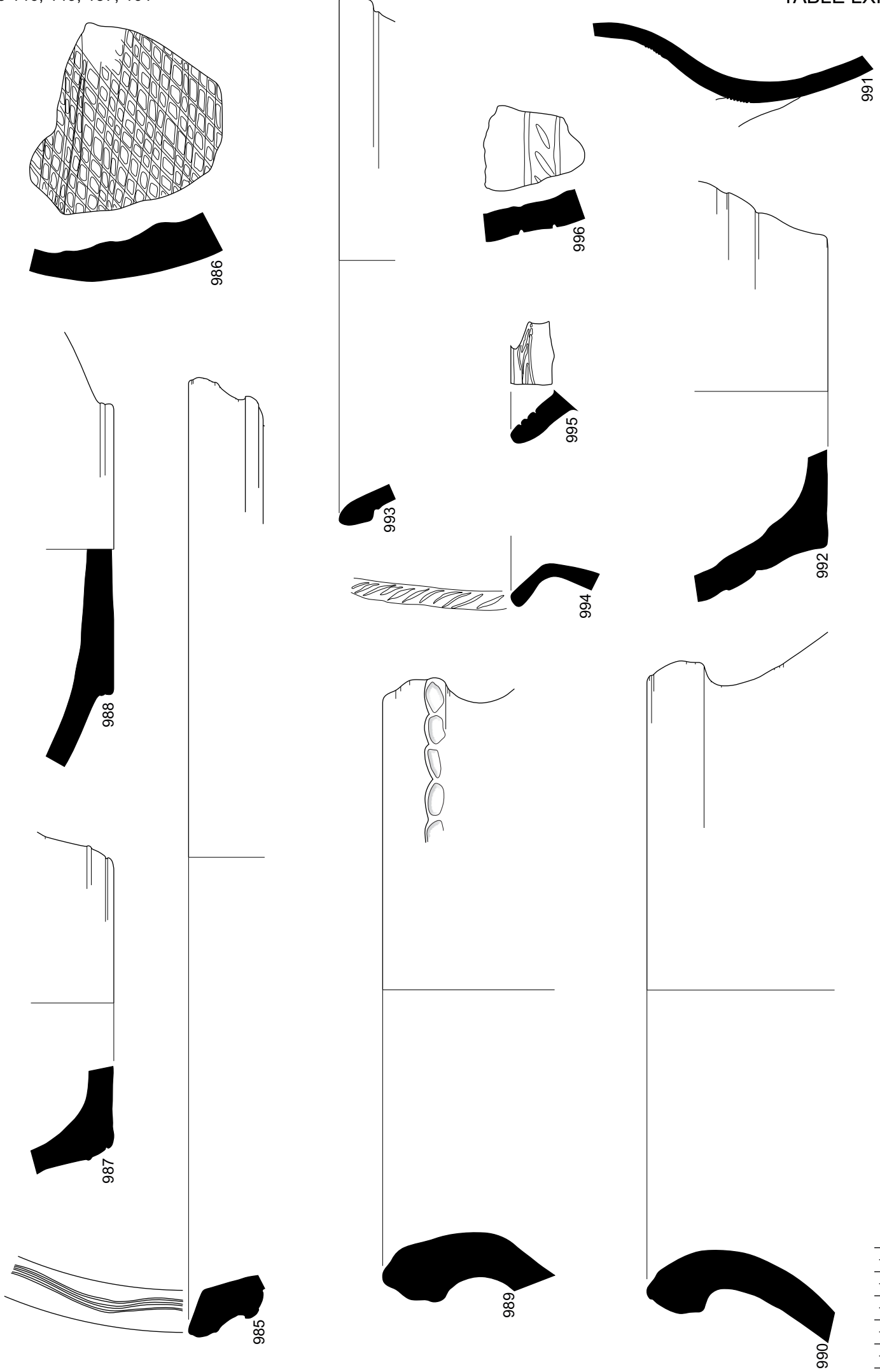

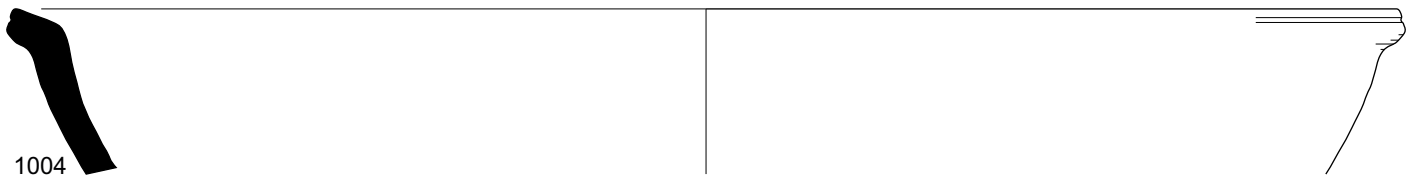
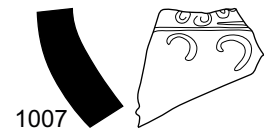
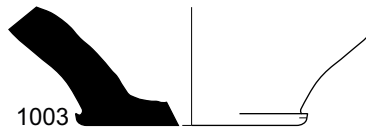
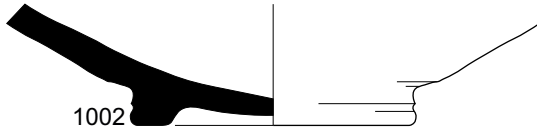
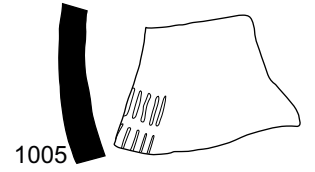
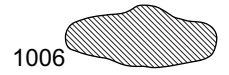
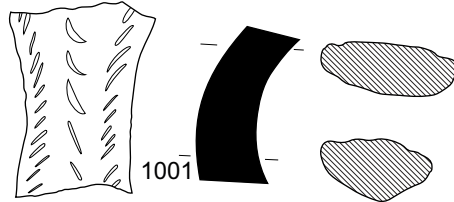
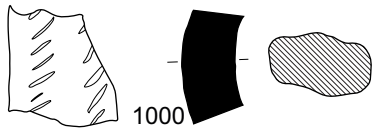
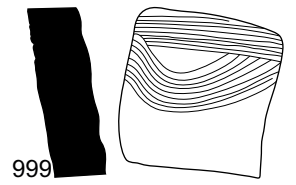
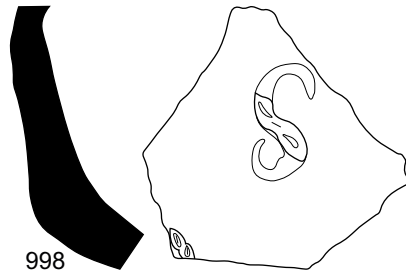
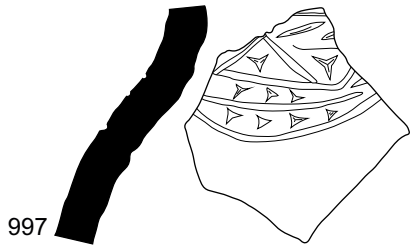

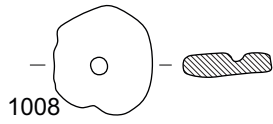

1008

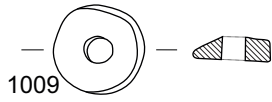

1009

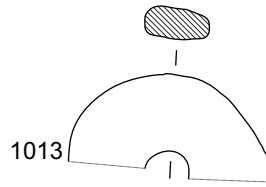

1013

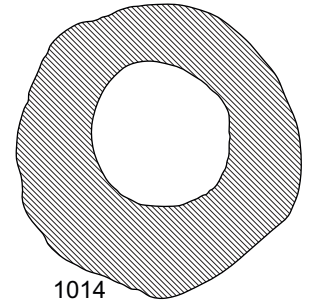

1014

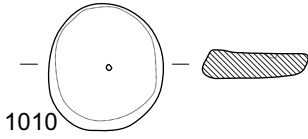

1010

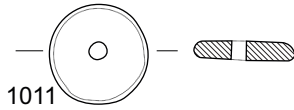

1011

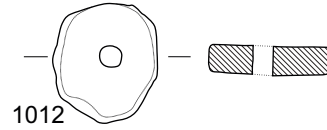

1012

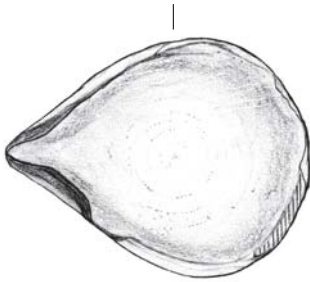

1015

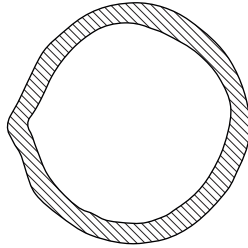

1016

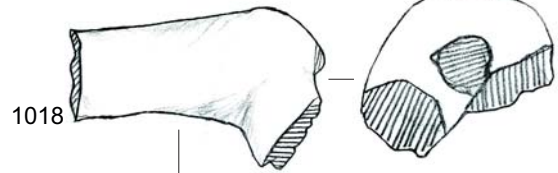

1018

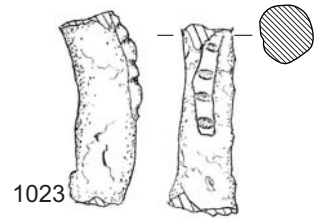
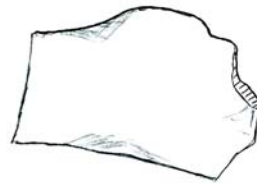
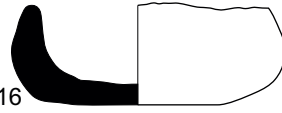

1023

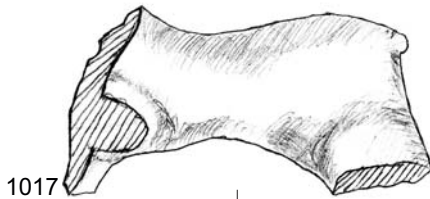

1017

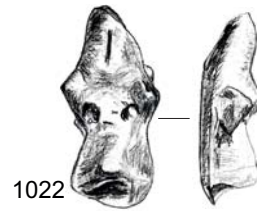
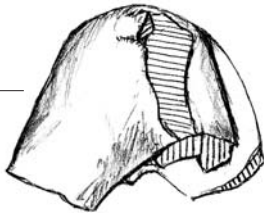

1022

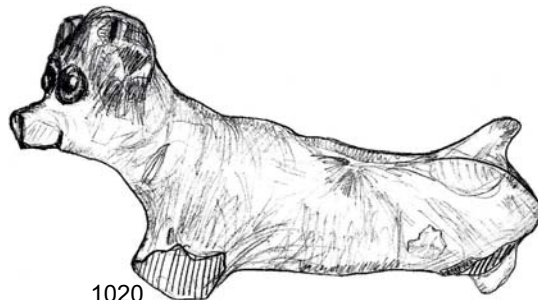
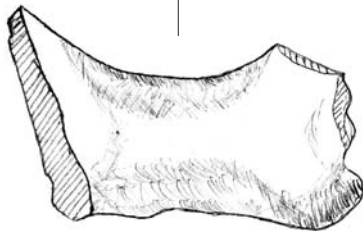

1020



1021

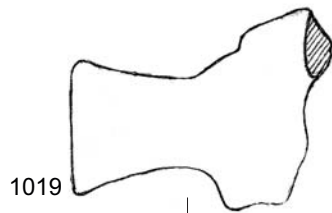

1019

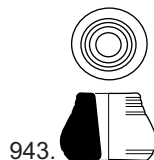
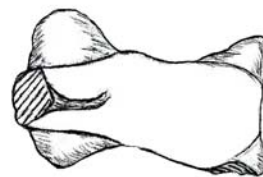

943.



944.

Supplementum V

PLATES

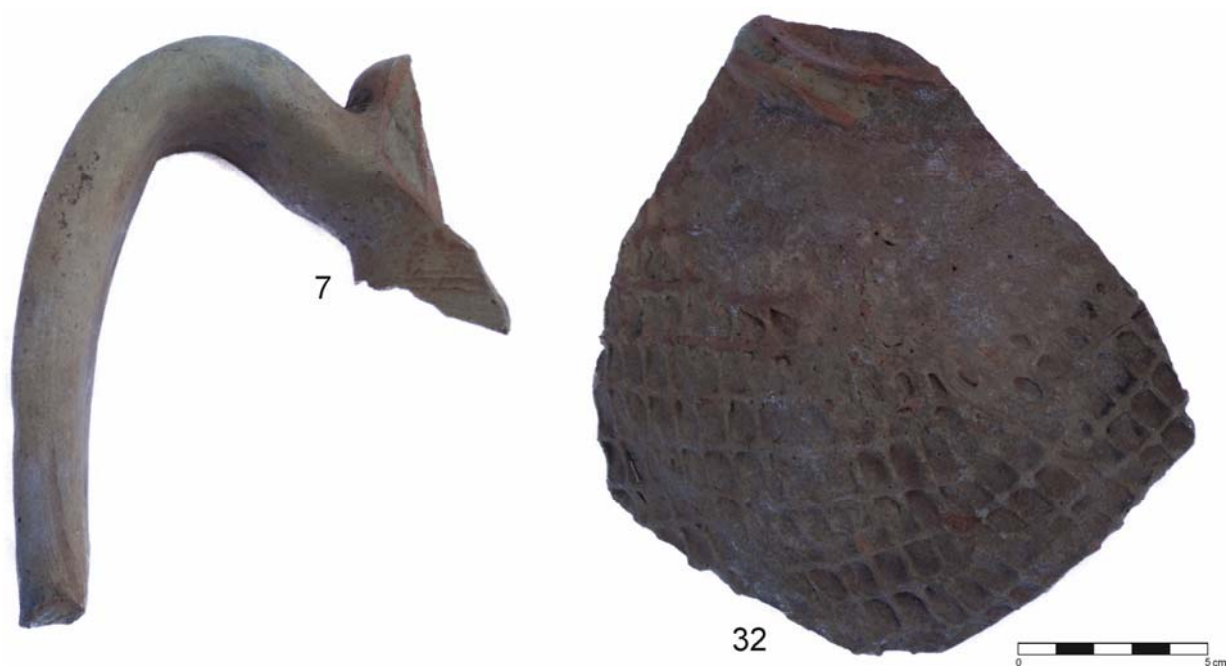

SITE 2: items 7 and 32.

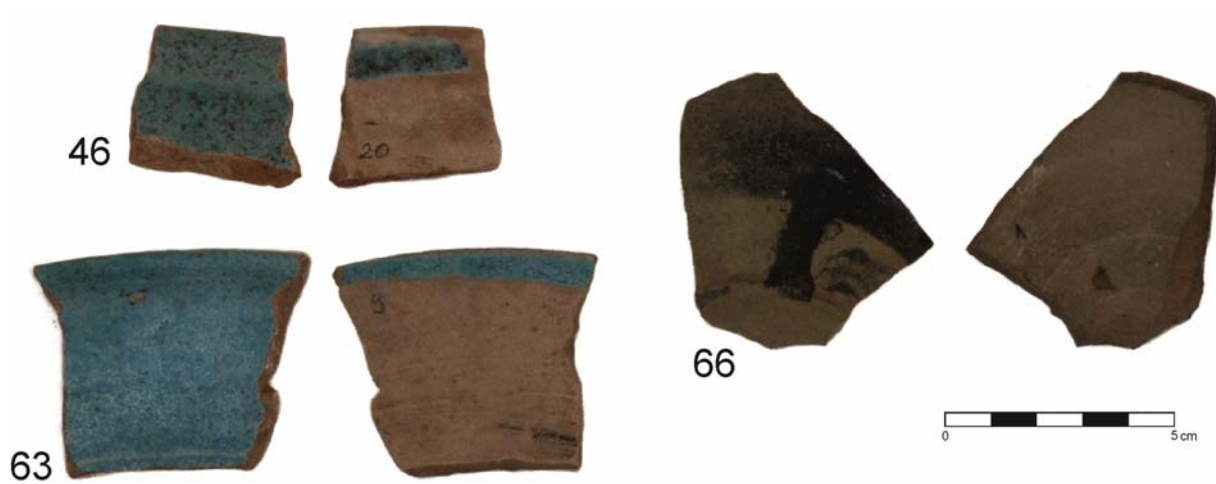

SITE 4: items 46, 63 and 66.

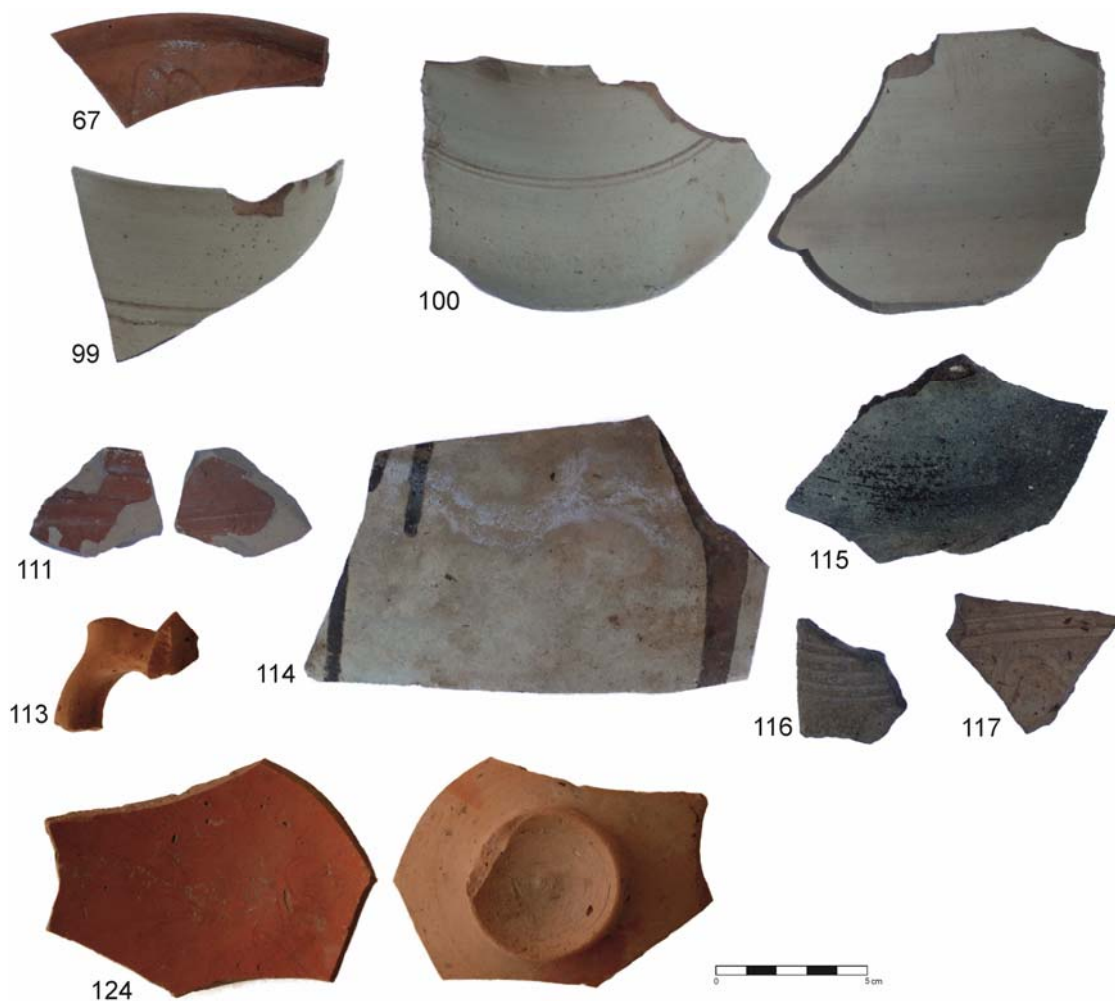

SITE 5: items 67, 99, 100, 111, 113, 114, 115, 116, 117 and 124.

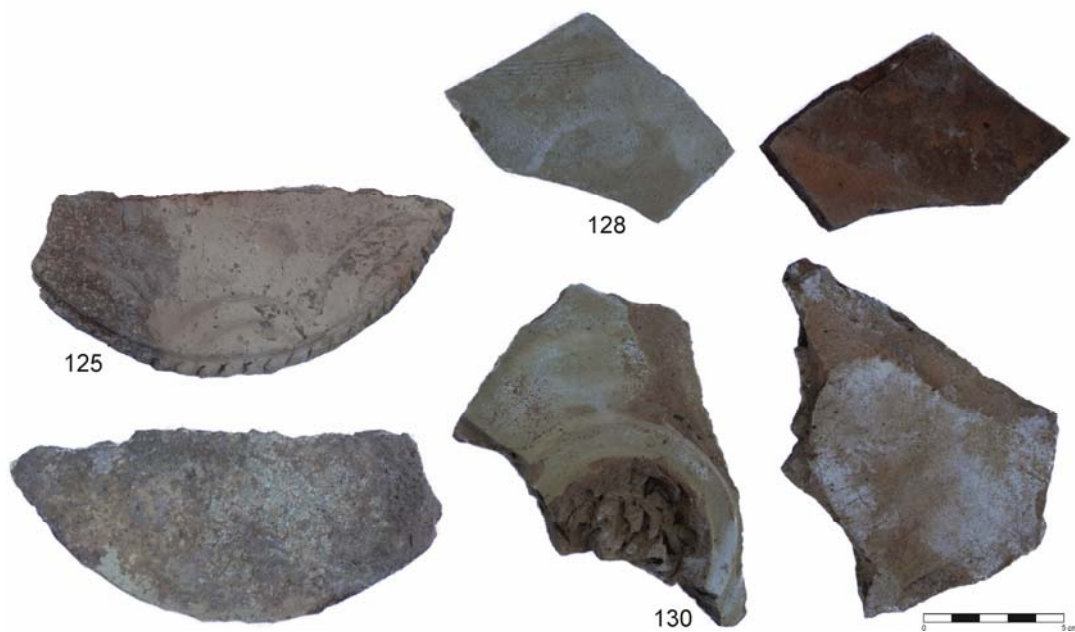

SITE 6: items 125, 128 and 130.



SITE 7: item 134.



SITE 8: items 139, 141, 142 and 153.



SITE 9: item 157.



158

172

183



181



SITE 10: items 158, 172, 181 and 183.



190



191

SITE 11: Items 190 and 191.



SITE 16: items 213, 222, 224, 238 and 239.



SITE 17: item 268.



SITE 19: item 300.



SITE 18: items 273, 287, 288.

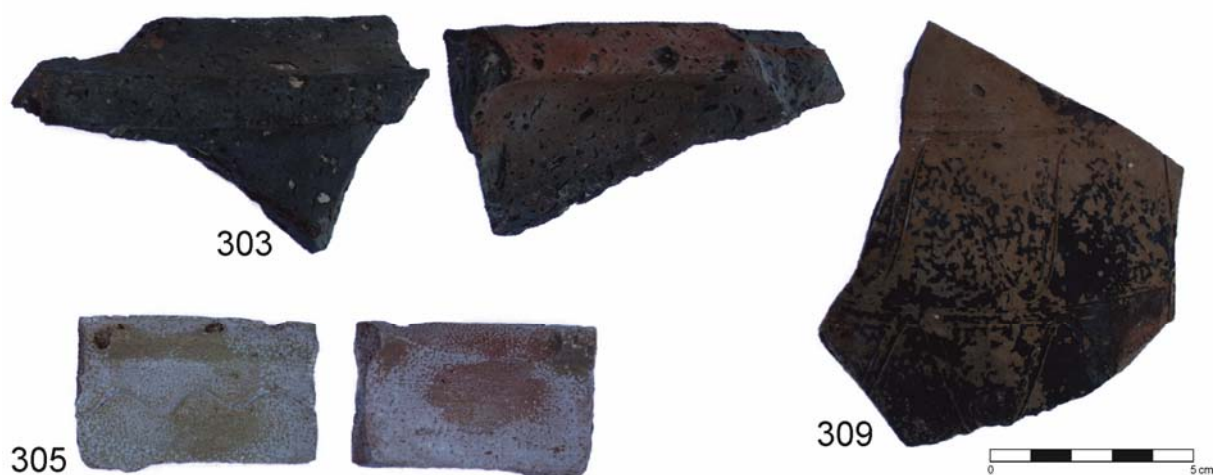

SITE 22: items 303, 305 and 309.



SITE 23: items 313, 315, 319, 320, 321 and 322.



SITE 24: items 334, 338, 348, 349, 350 and 355.

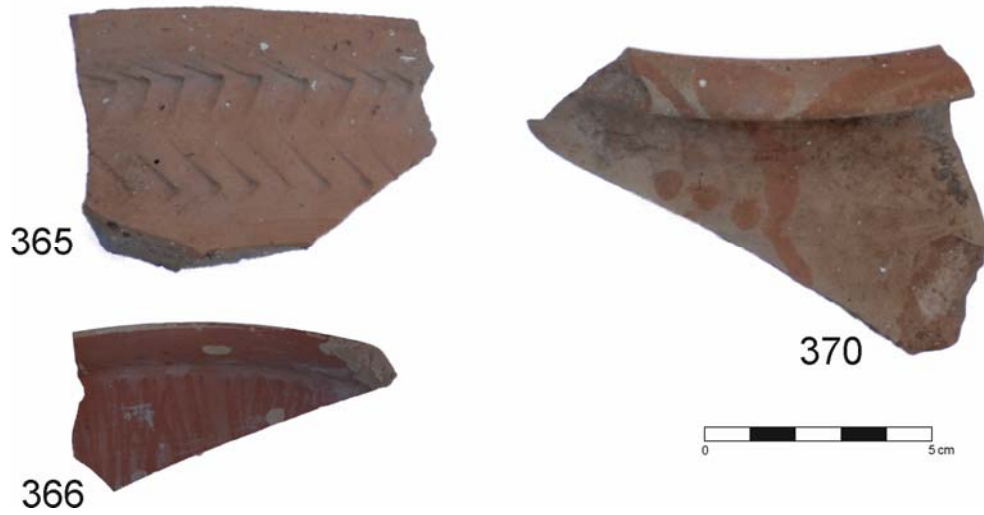

SITE 25: items 365, 366 and 370.



SITE 26.: items 400, 425 and 432.

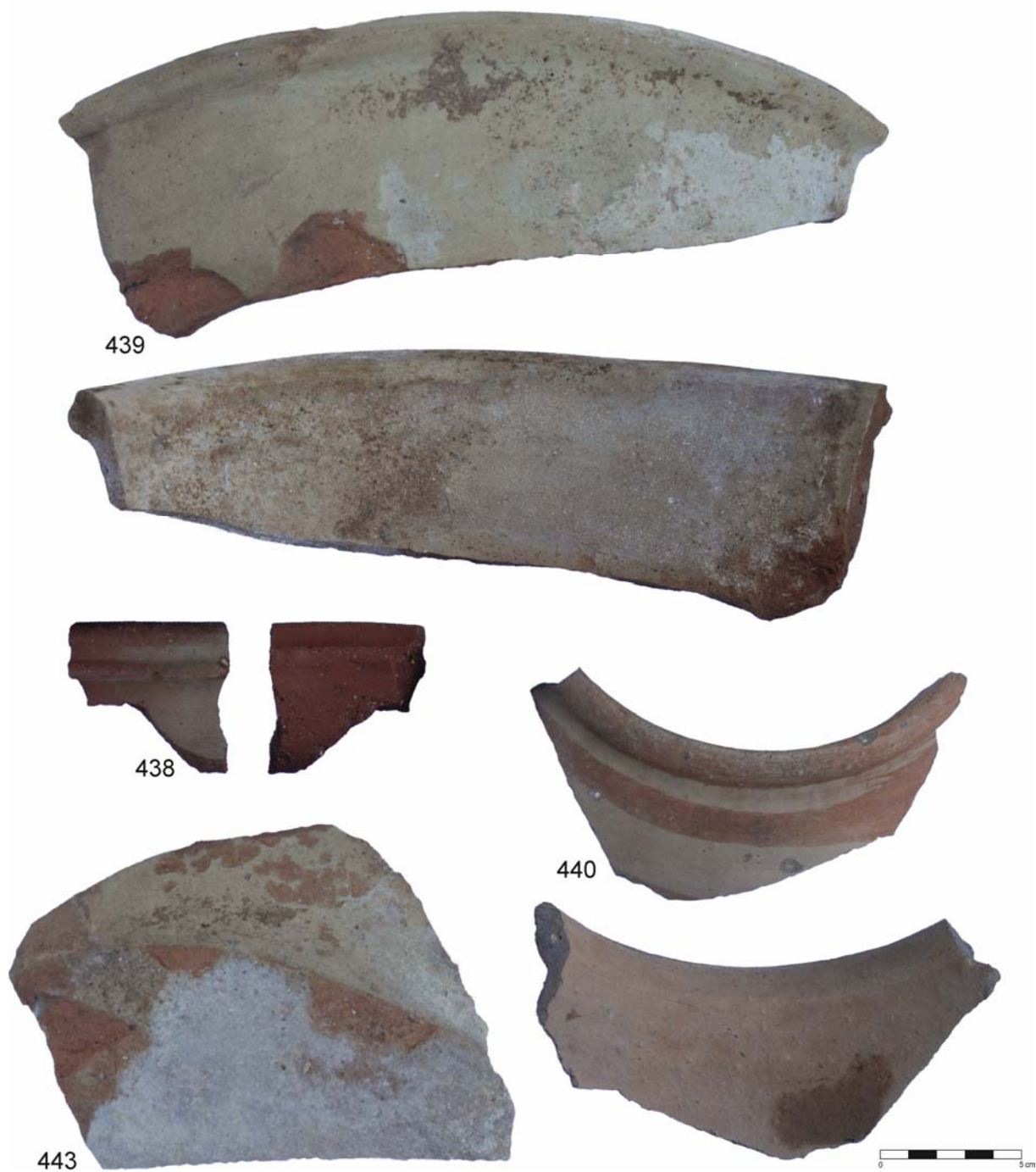

SITE 27: items 438, 439, 440 and 443.

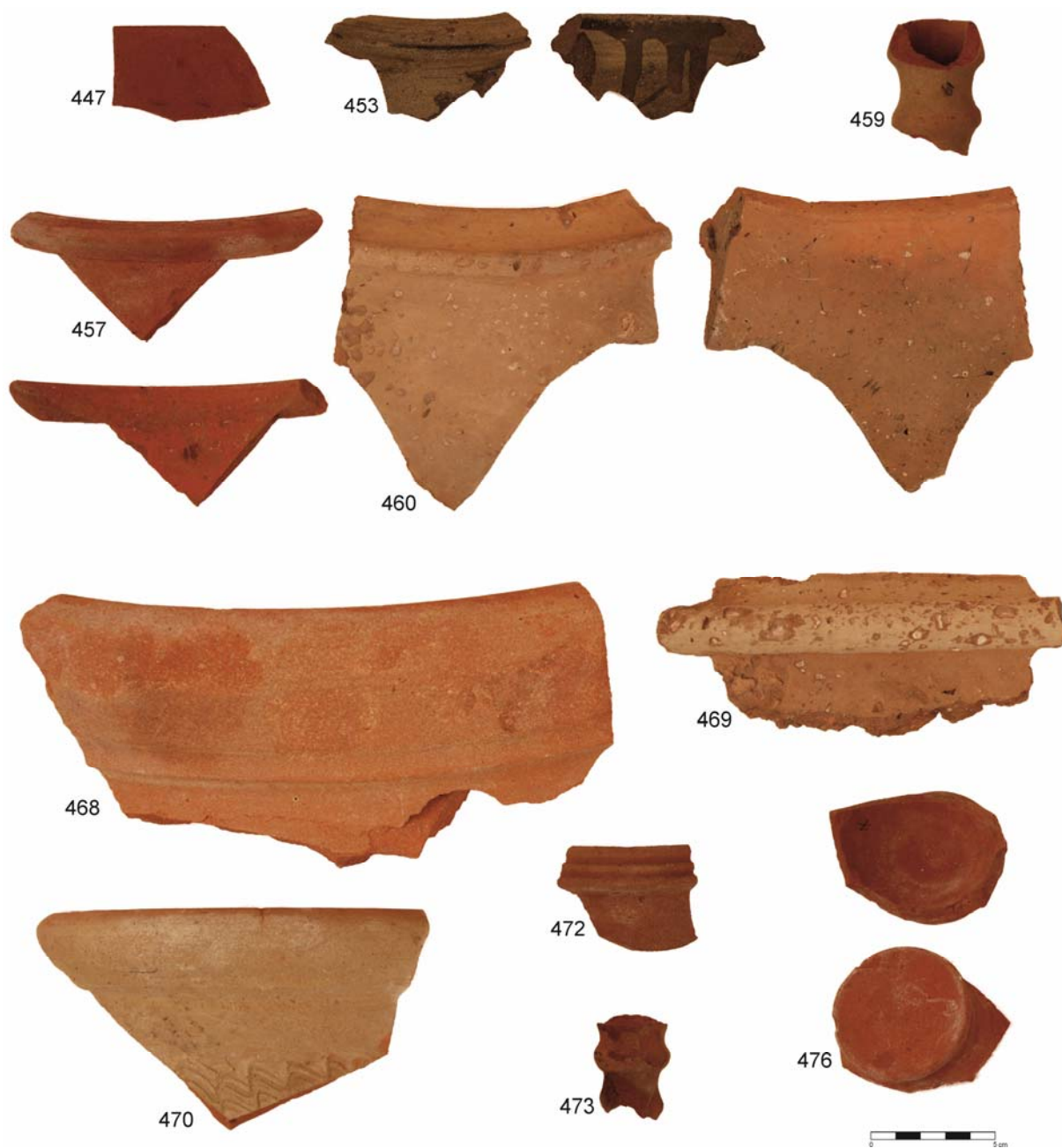

SITE 32: items 447, 453, 457, 459, 460, 468, 469, 470, 472, 473 and 476.



SITE 33: item 479.



SITE 33: item 480.



SITE 33: items 485, 488, 492, 494, 495, 496, 500, 501, 502 and 503.

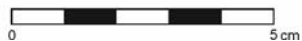

SITE 35: item 507.



SITE 40: item 545.



510



511



SITE 36: items 510 and 511.



558

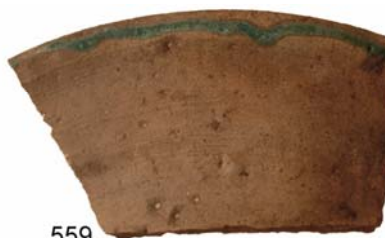

559



SITE 41: items 558 and 559.

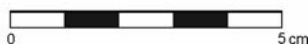

SITE 43: item 587.



SITE 48: items 601, 604 and 607.



SITE 49: item 608.

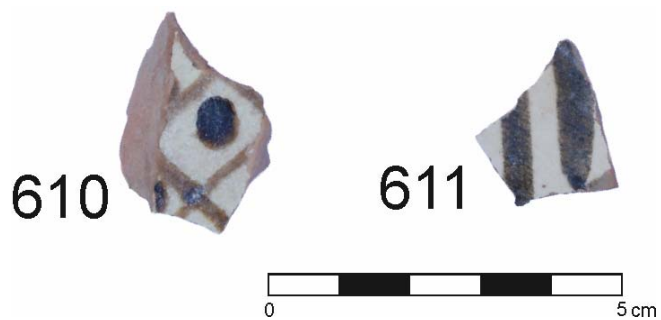

SITE 50: items 610 and 611.



SITE 54: item 619.

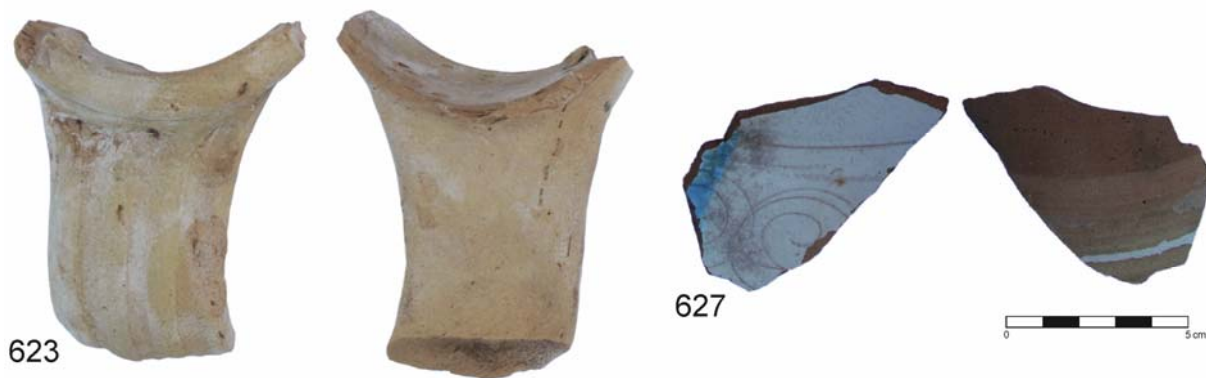

SITE 55: items 623 and 627.

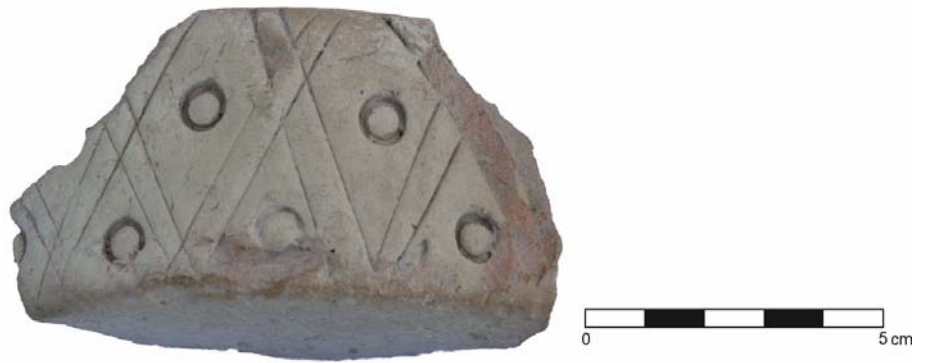

SITE 56: item 631.



SITE 57: item 645 and 646.



SITE 61: items 659 and 661.



SITE 62: item 662.

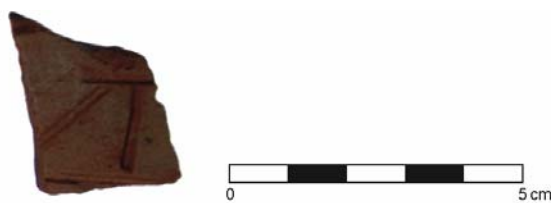

SITE 63: item 671.



SITE 75: item 687.



SITE 72: items 679, 680, 681 and 682.



702

700



SITE 79: items 700 and 702.



706



723



725



SITE 80: items 706, 723 and 725.



SITE 88: items 730, 731, 732, 733, 736 and 738.



SITE 90: item 739.



SITE 94: items 746, 748, 752, 753, 761 and 765.

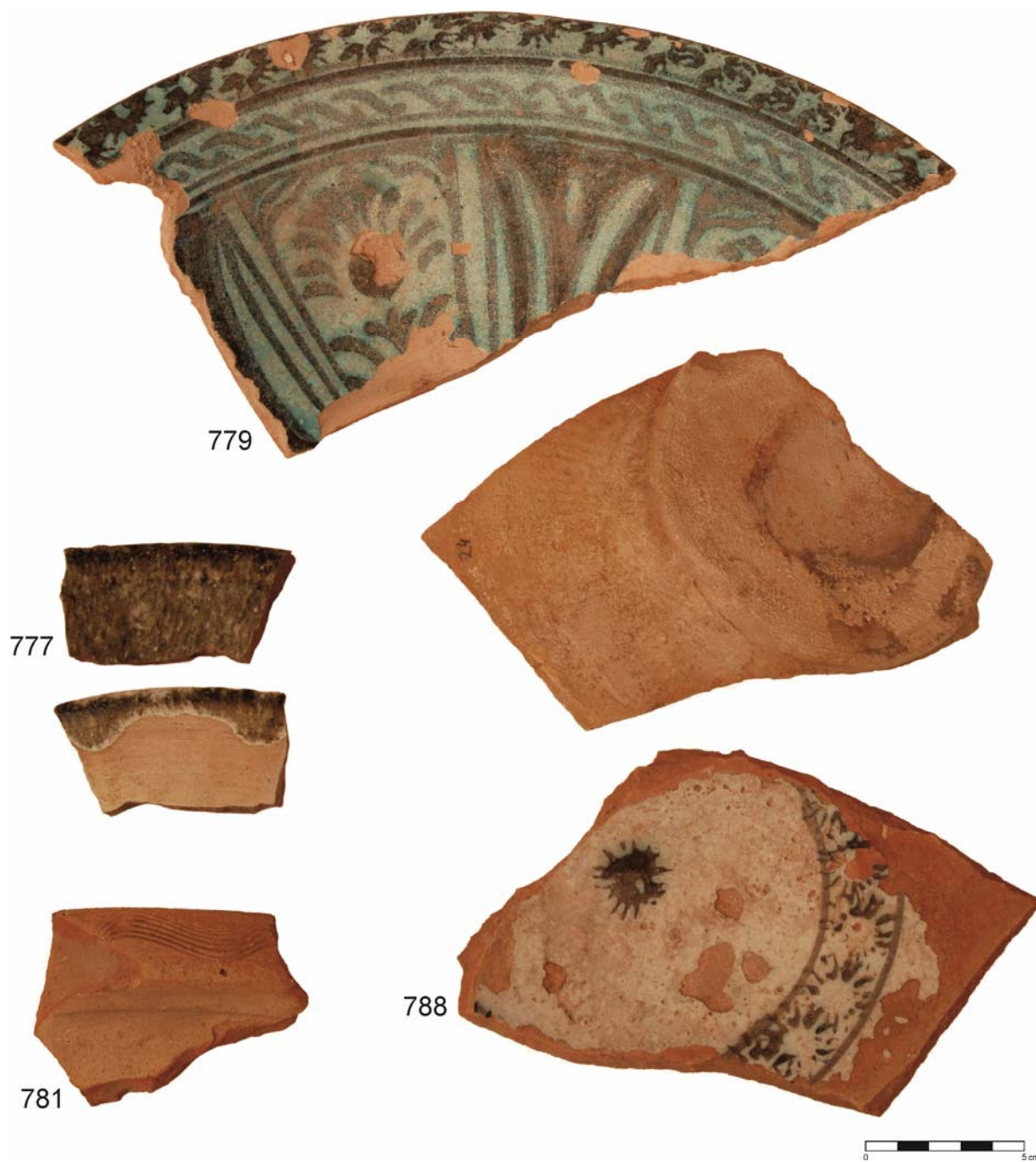

SITE 95: items 777, 779, 781 and 788.



SITE 98: item 799.

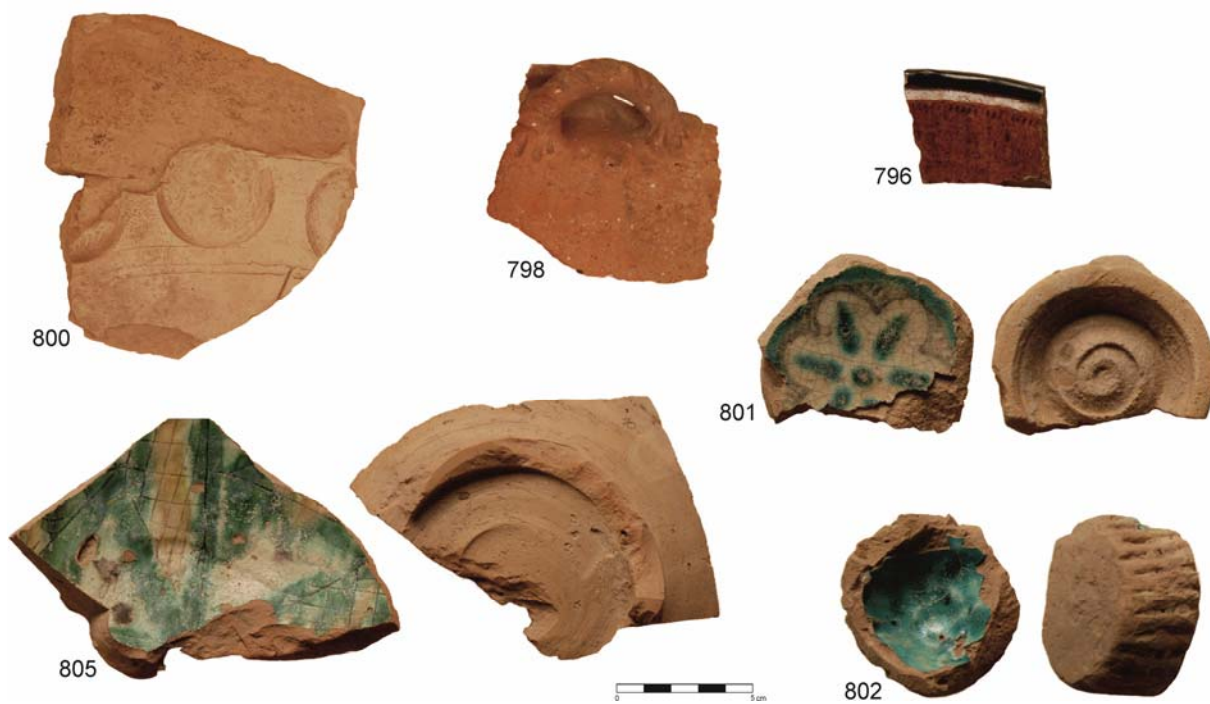

SITE 98: items 796, 798, 800, 801, 802 and 805.



SITE 99: items 810, 814, 817, 821, 822 and 823.



SITE 100: items 830, 837 and 839.

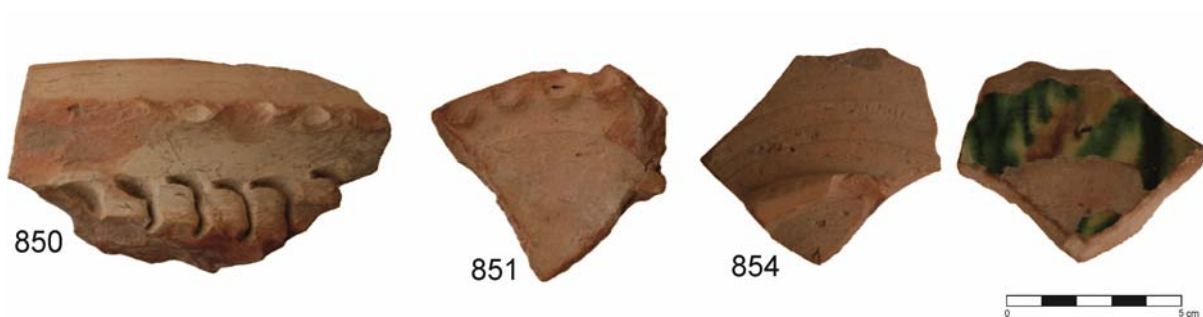

SITE 103.: items 850, 851 and 854.



SITE 110: item 884.



SITE 116: item 894.



SITE 117: items 896 and 897.



SITE 120: items 906, 907 and 908.



SITE 124: item 909.



SITE 127: item 922.



SITE 128: items 923, 926 and 927.



SITE 129: item 928.



SITE 131: item 934.



SITE 133: item 939.



SITE 134: items 947 and 948.



SITE 135: item 951.

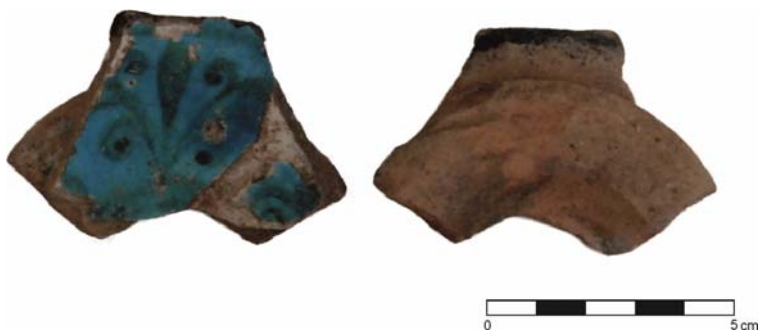

SITE 142: item 961.



SITE 143: item 969.

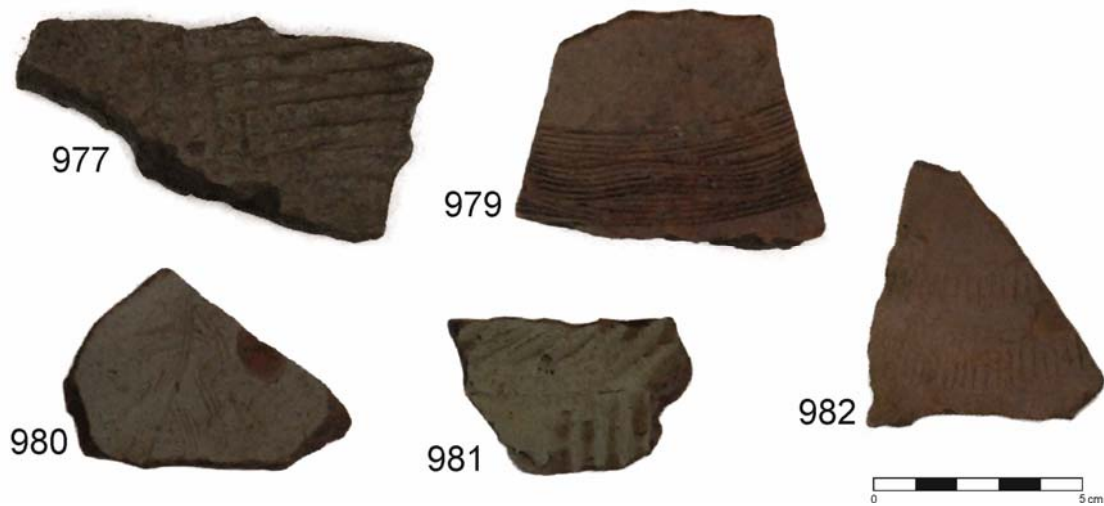

SITE 145: items 977, 979, 980, 981 and 982.



SITE 146: item 986.



SITE 157: item 991.



SITE 161: items 994, 995, 996, 997, 998 and 1000.



SITE 165: Item 1007.



SITES 4/5/26/72: tokens 1008, 1009, 1011 and 1013.



1015

1016

SITE 60/48: terracotta lamps 1015 and 1016.



SITE 80: bead 1024.



1021

1022

1023

SITES 61/98/51: statuettes 1021, 1022 and 1023.

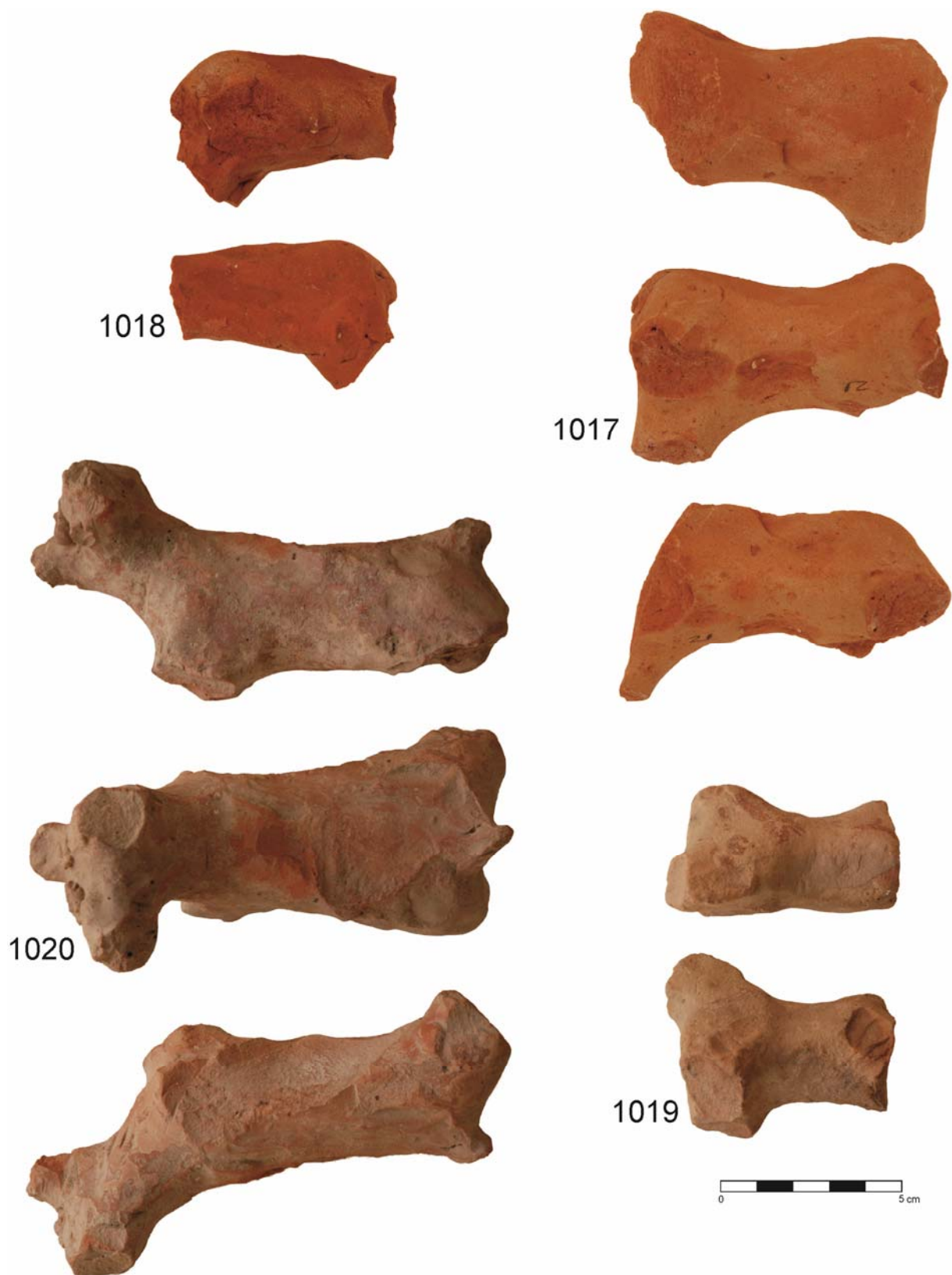

SITES 32/99/48: zoomorphic statuettes 1017, 1018, 1019 and 1020.

LIST OF PLATES

- Plate I:* SITE 2: items 7, and 32.
SITE 4: items 46, 63 and 66.
- Plate II:* SITE 5: items 67, 99, 100, 111, 113, 114, 115, 116, 117 and 124.
SITE 6: items 125, 128 and 130.
- Plate III:* SITE 7: item 134.
SITE 8: items 139, 141, 142, and 153.
SITE 9: item 157.
- Plate IV:* SITE 10: items 158, 172, 181 and 183.
SITE 11: Items 190, 191.
- Plate V:* SITE 16: items 213, 222, 224, 238 and 239.
SITE 17: item 268.
SITE 19: item 300.
- Plate VI:* SITE 22: items 303, 305 and 309.
SITE 23: items 313, 315, 319, 320, 321 and 322.
- Plate VII:* SITE 24: items 334, 338, 348, 349, 350 and 355.
SITE 25: items 365, 366 and 370.
SITE 26.: items 400, 425 and 432.
- Plate VIII:* SITE 27: items 438, 439, 440 and 443.
- Plate IX:* SITE 32: items 447, 453, 457, 459, 460, 468, 469, 470, 472, 473 and 476.
- Plate X:* SITE 33: item 479.
- Plate XI:* SITE 33: item 480.
- Plate XII:* SITE 33: items 485, 488, 492, 494, 495, 496, 500, 501, 502 and 503.
- Plate XIII:* SITE 35: item 507.
SITE 36: items 510 and 511.
SITE 40: item 545.
SITE 41: items 558 and 559.
SITE 43: item 587.
- Plate XIV:* SITE 48: items 601, 604 and 607.
SITE 49: item 608.
- Plate XV:* SITE 50: items 610 and 611.
SITE 54: item 619.
SITE 55: items 623 and 627.
- Plate XVI:* SITE 56: item 631.
SITE 57: item 645 and 646.
SITE 61: items 659 and 661.
- Plate XVII:* SITE 62: item 662.
SITE 63: item 671.
SITE 75: item 687.
- Plate XVIII:* SITE 72: items 679, 680, 681 and 682.
- Plate XIX:* SITE 79: items 700 and 702.
SITE 80: items 706, 723 and 725.

- Plate XX:* SITE 88: items 730, 731, 732, 733, 736 and 738.
- Plate XXI:* SITE 90: item 739.
SITE 94: items 746, 748, 752, 753, 761 and 765.
- Plate XXII:* SITE 95: items 777, 779, 781 and 788.
- Plate XXIII:* SITE 98: item 799.
- Plate XXIV:* SITE 98: items 796, 798, 800, 801, 802 and 805.
SITE 99: items 810, 814, 817, 821, 822 and 823.
- Plate XXV:* SITE 100: items 830, 837 and 839.
SITE 103.: items 850, 851 and 854.
SITE 110: item 884.
- Plate XXVI:* SITE 116: item 894.
SITE 117: items 896 and 897.
SITE 120: items 906, 907 and 908.
- Plate XXVII:* SITE 124: item 909.
SITE 127: item 922.
SITE 128: items 923, 926 and 927.
- Plate XXVIII:* SITE 129: item 928.
SITE 131: item 934.
SITE 133: item 939.
- Plate XXIX:* SITE 134: items 947 and 948.
SITE 135: item 951.
SITE 142: item 961.
SITE 143: item 969.
- Plate XXX:* SITE 145: items 977, 979, 980, 981 and 982.
SITE 146: item 986.
SITE 157: item 991.
- Plate XXXI:* SITE 161: items 994, 995, 996, 997, 998 and 1000.
SITE 165: item 1007.
SITES 4/5/26/72: tokens 1008, 1009, 1011 and 1013.
- Plate XXXII:* SITE 60/48: terracotta lamps 1015 and 1016.
SITE 80: bead 1024.
SITES 61/98/51: statuettes 1021, 1022 and 1023.
- Plate XXXIII:* SITES 32/99/48: zoomorphic statuettes 1017, 1018, 1019 and 1020.