

HROB 3

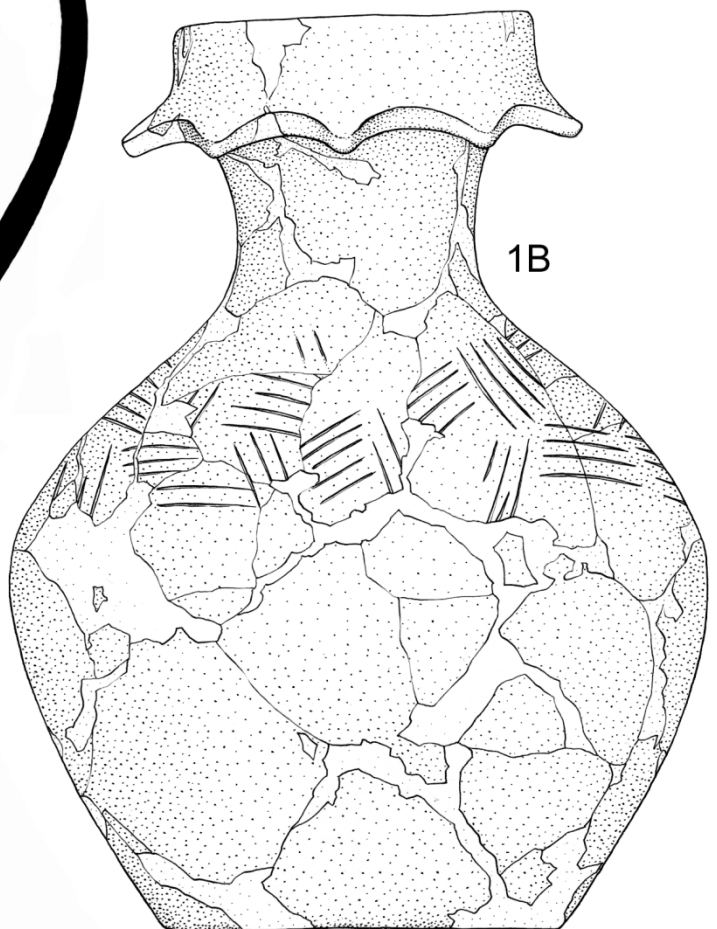

HROB 3

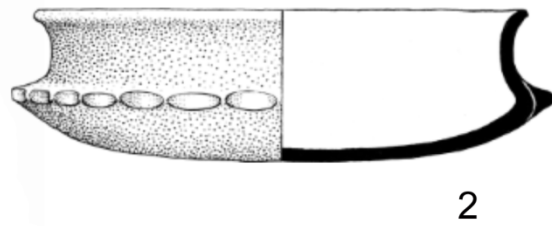
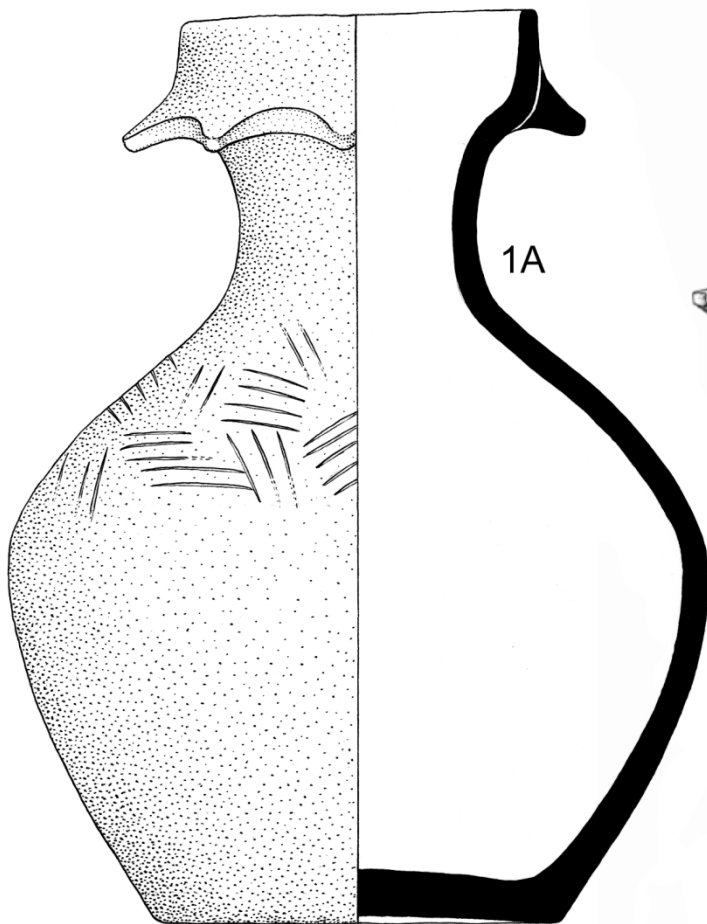
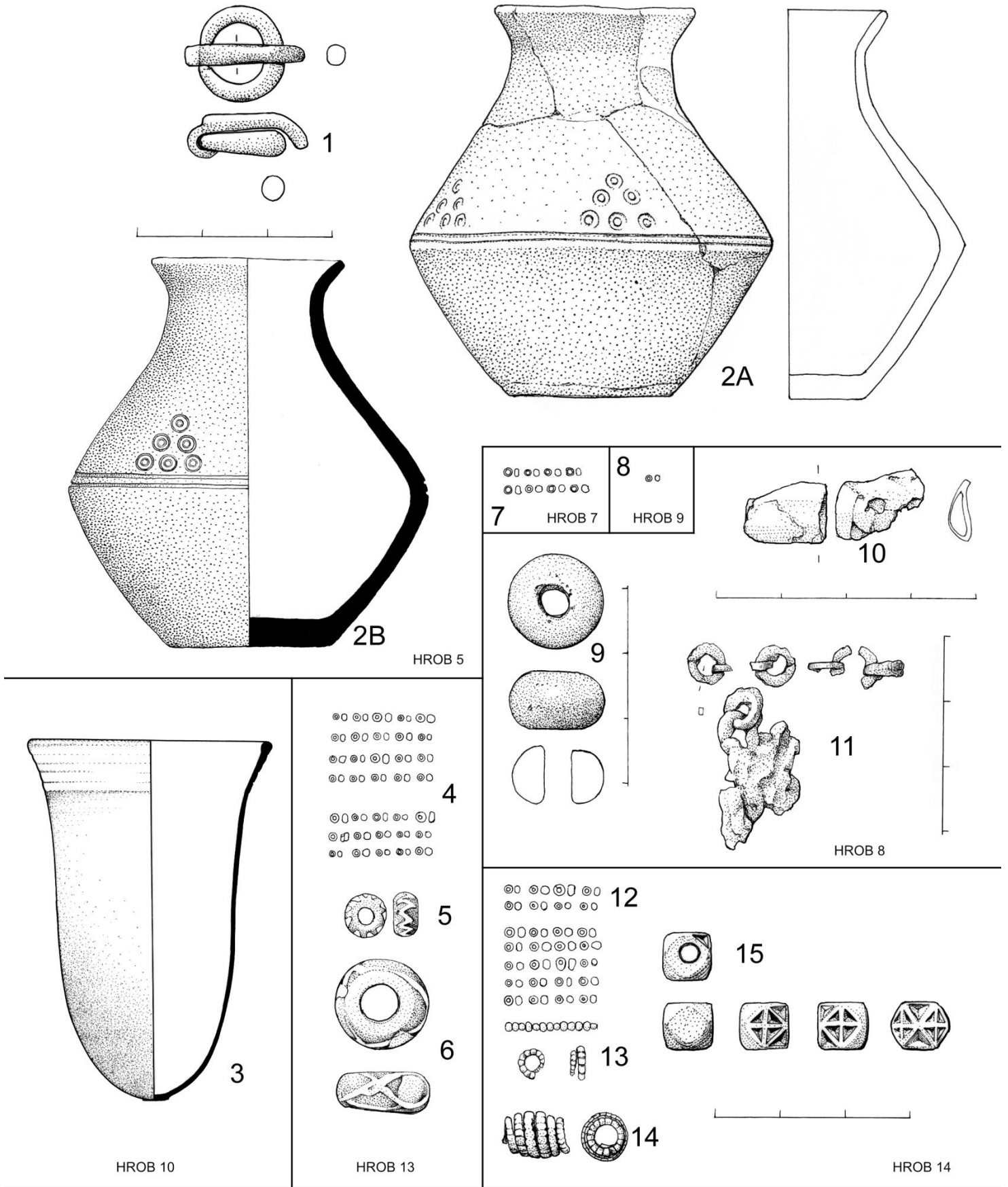

TABULKA 3

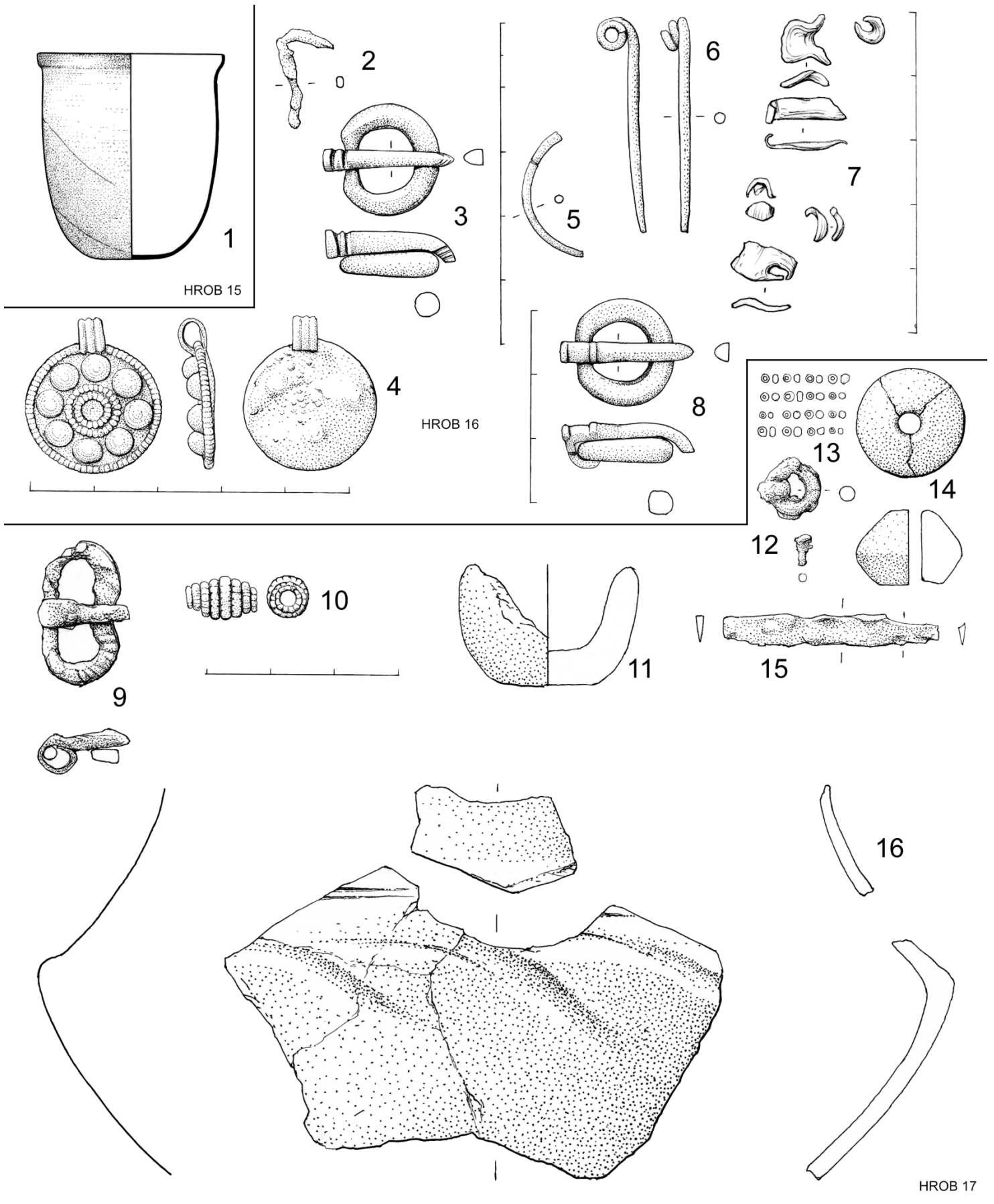

TABULKA 4

HROB 17

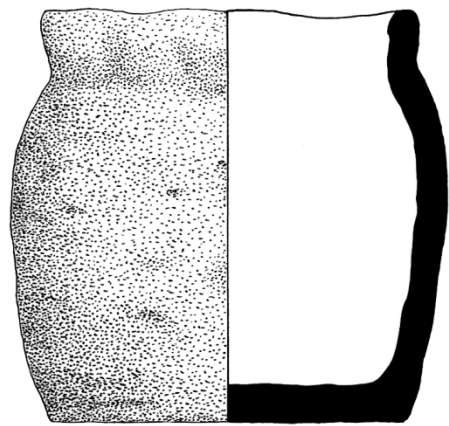

1

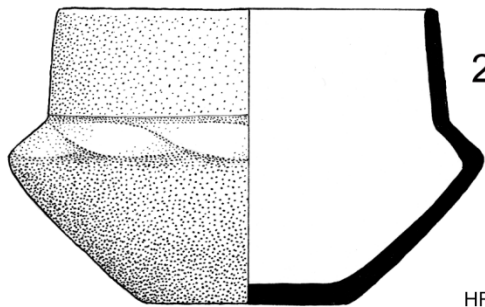

2

HROB 17

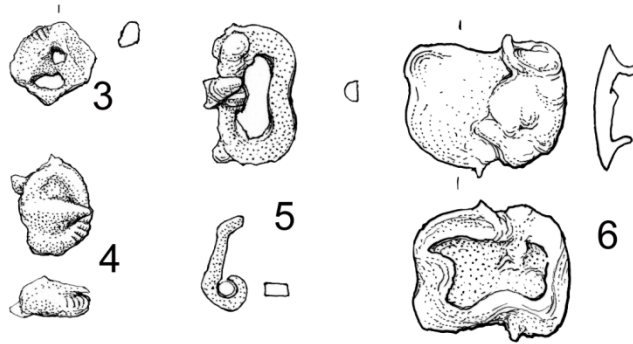

HROB 18

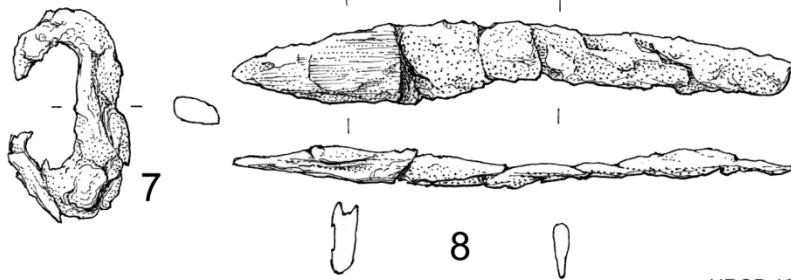

HROB 19

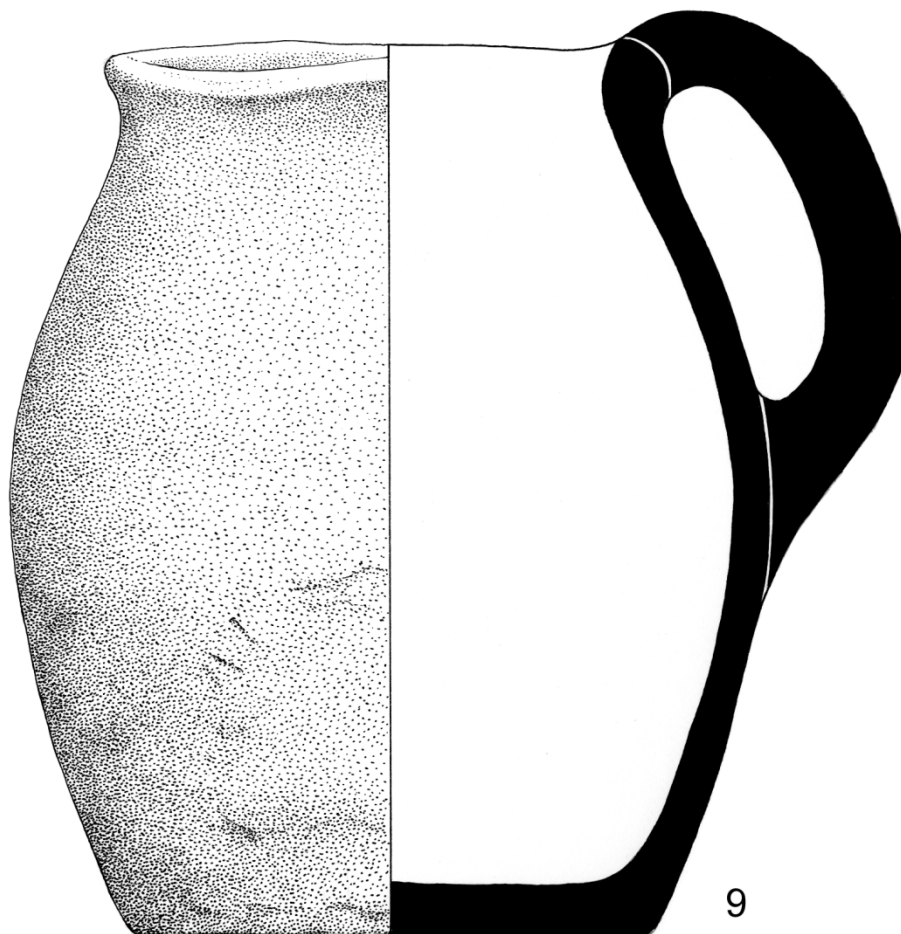

9

HROB 20

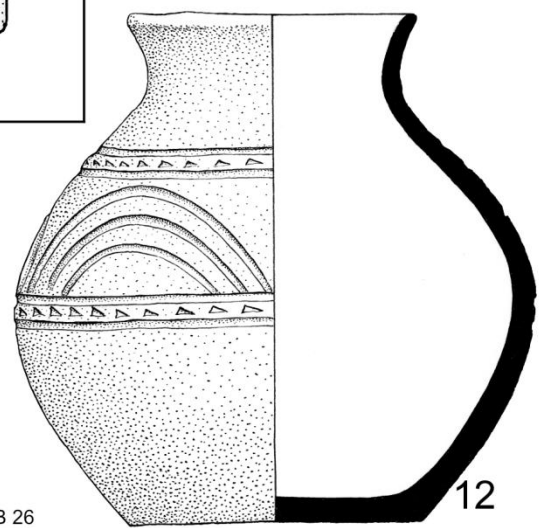
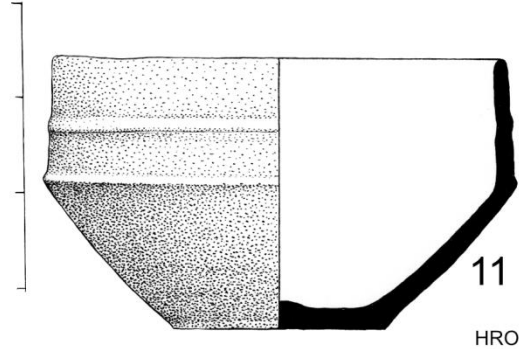
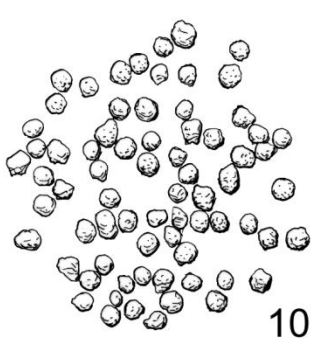
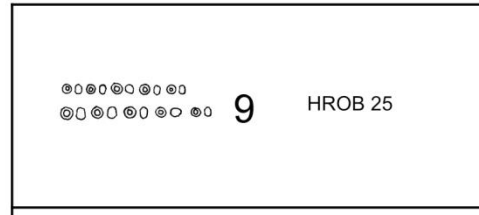
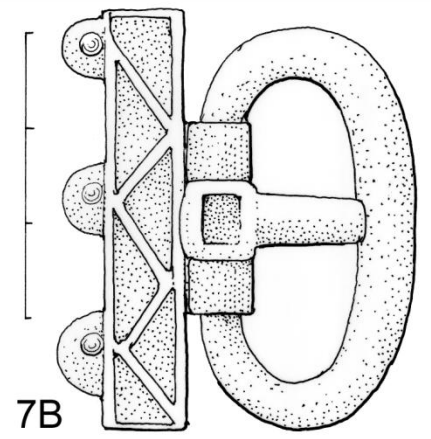
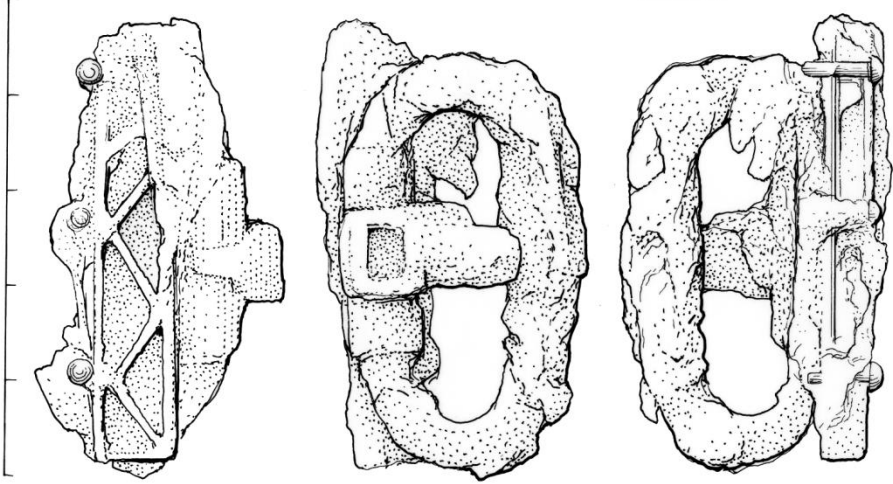
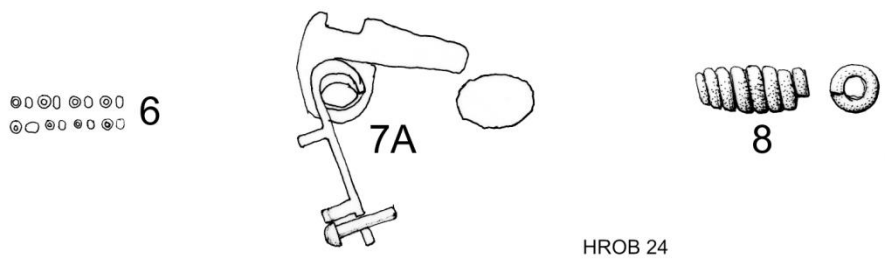
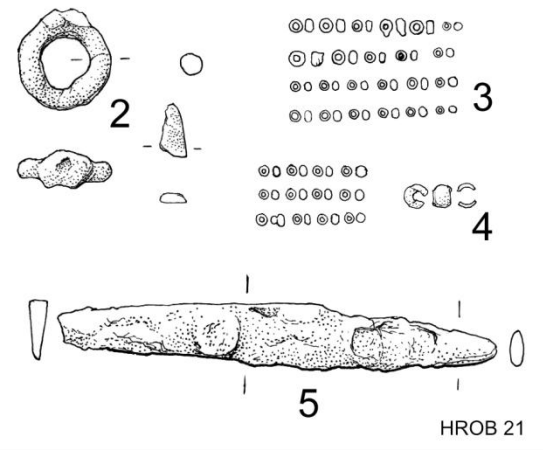
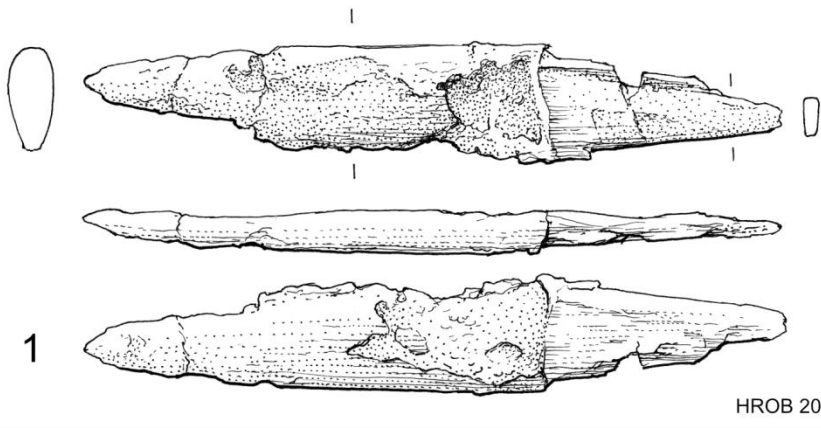

TABULKA 6

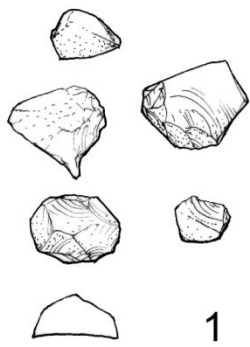

HROB 30

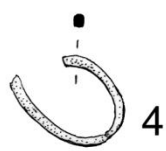
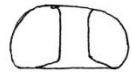
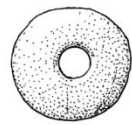
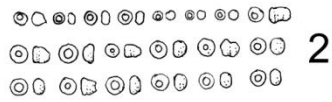

HROB 31

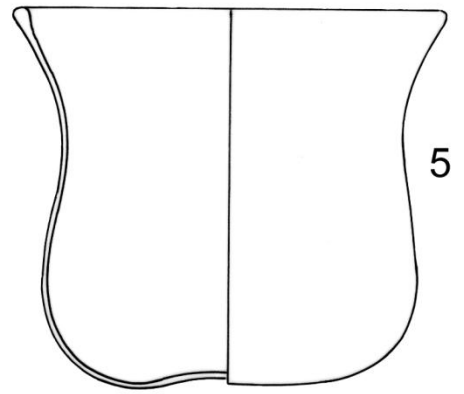

HROB 32

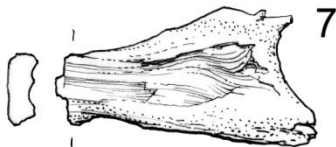

HROB 34

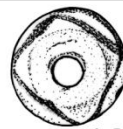
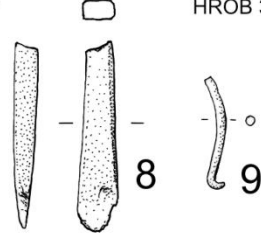

12

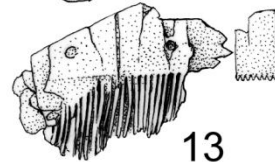

13

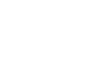
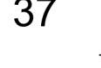
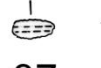
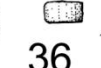

20-29

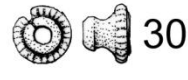

35

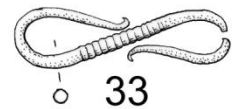

33



HROB 35

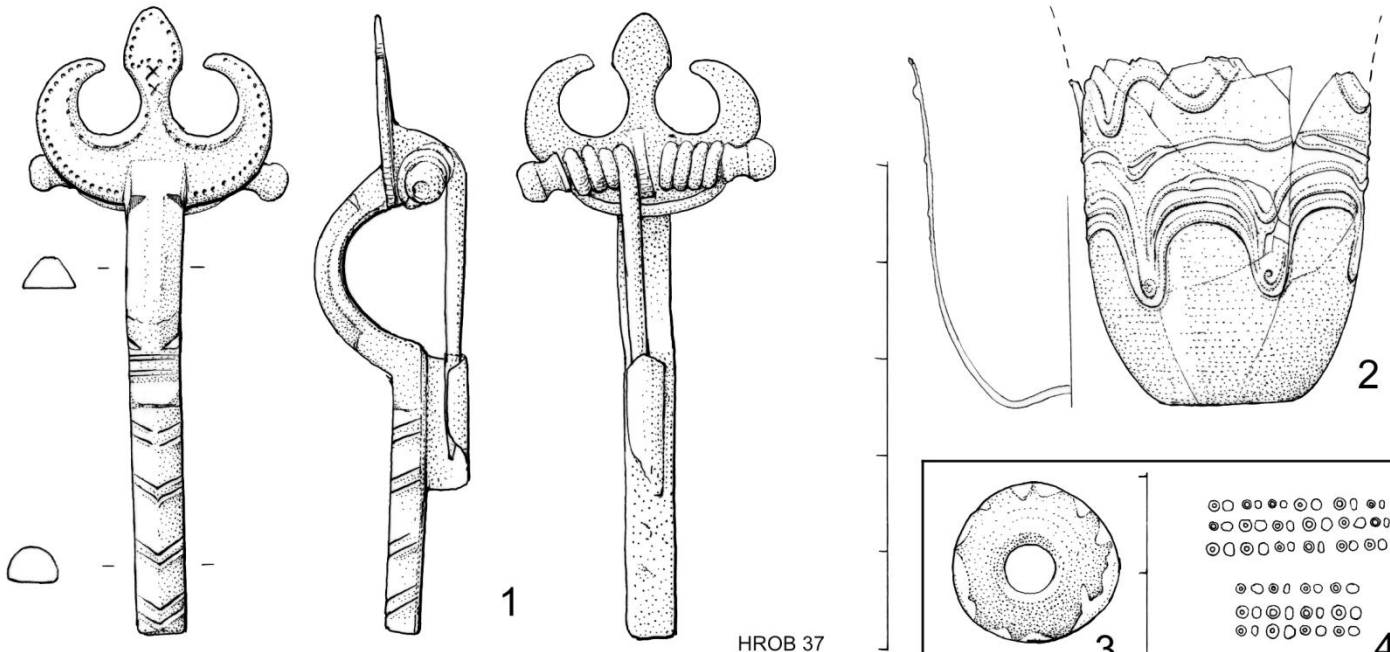

HROB 37

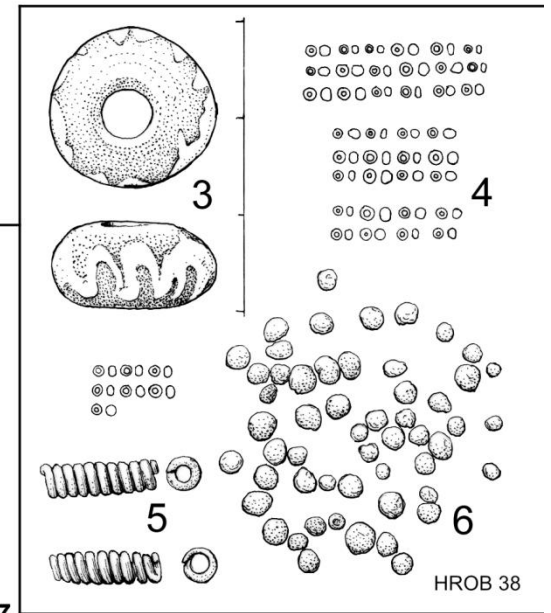

HROB 38

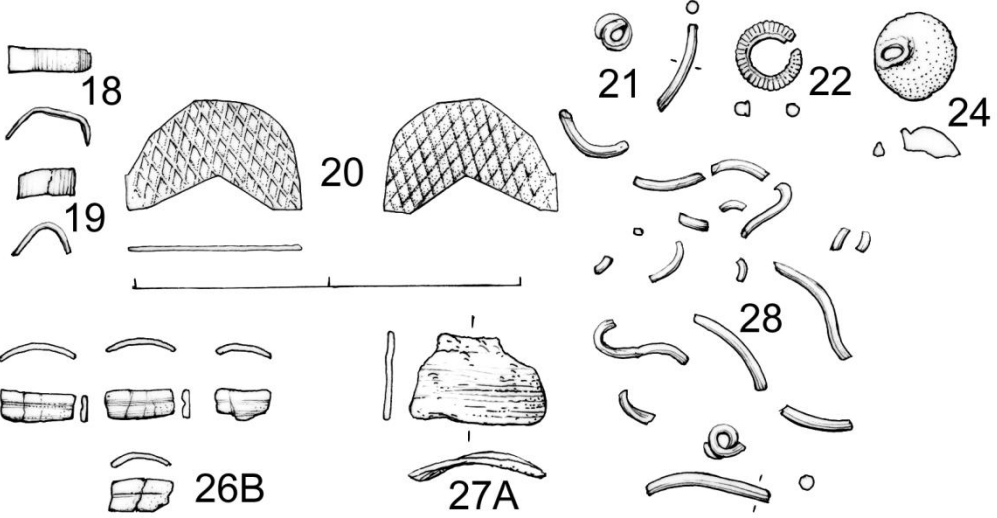
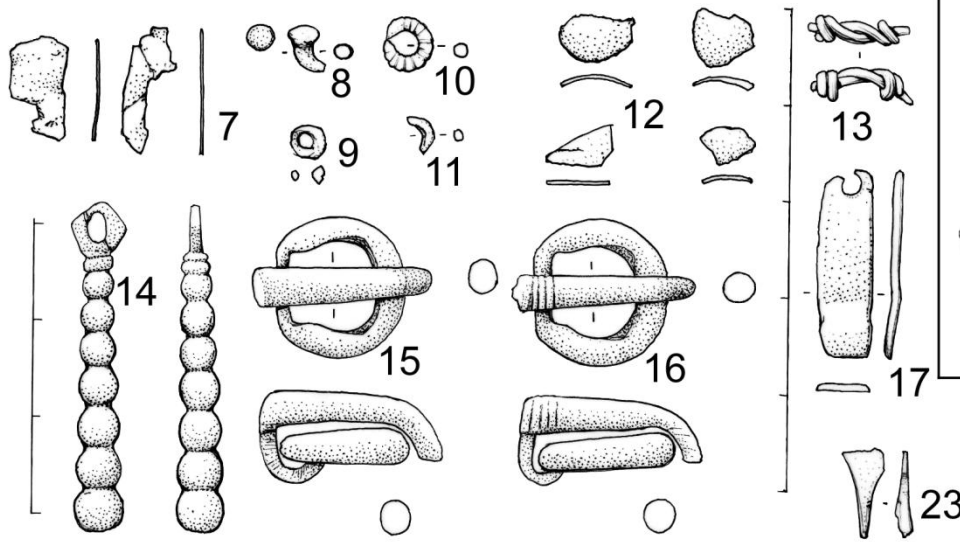

HROB 41

TABULKA 8

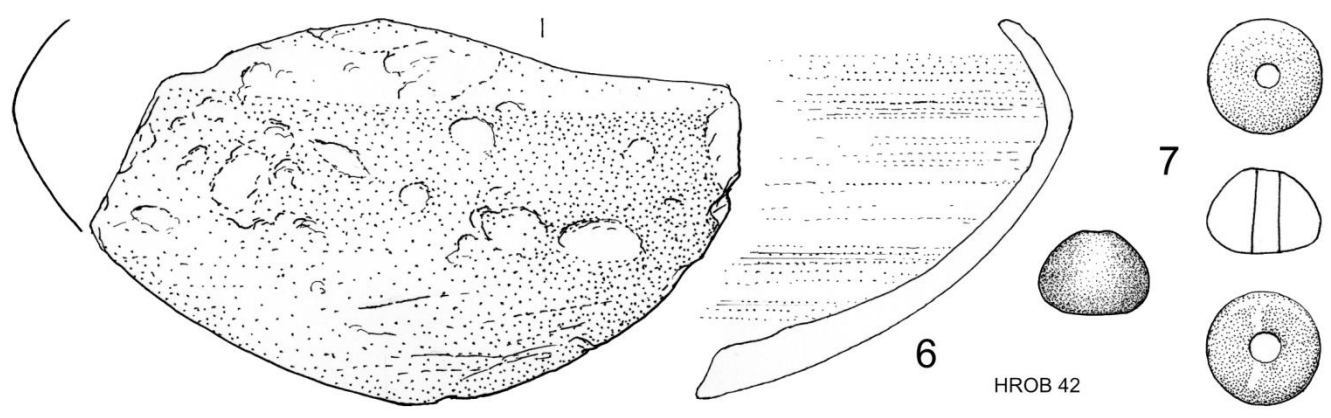
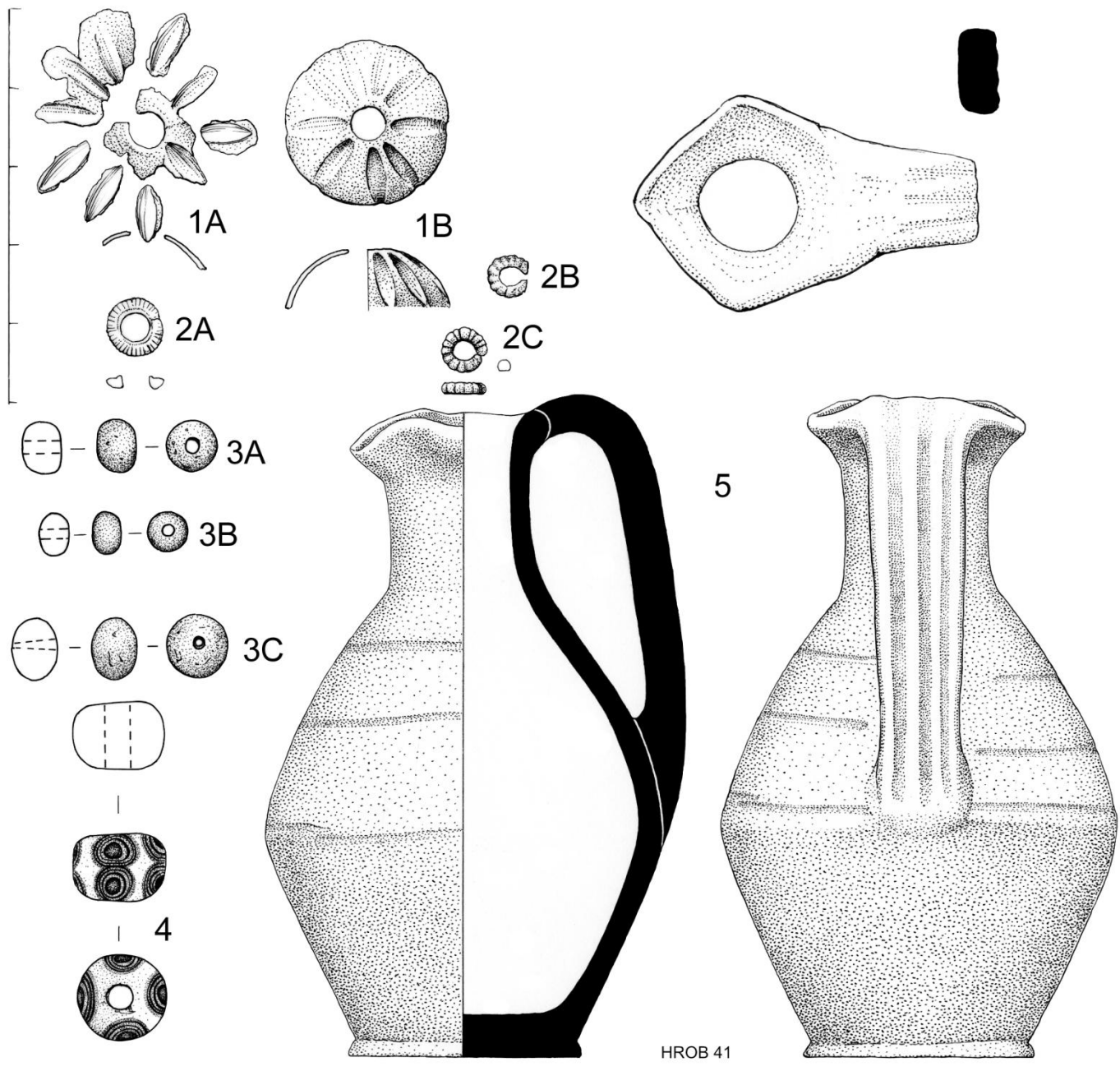

TABULKA 9

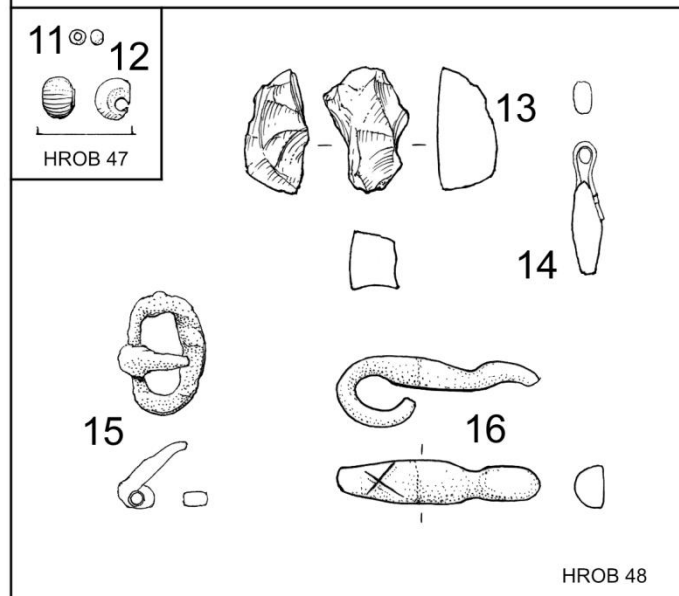
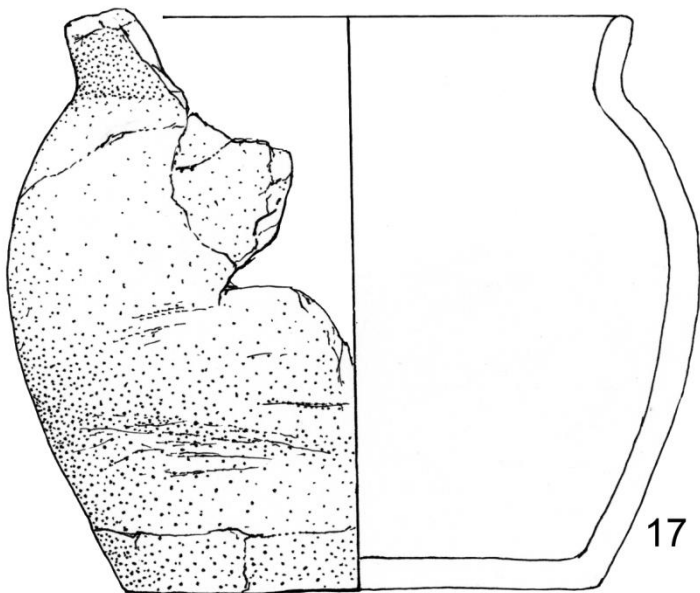
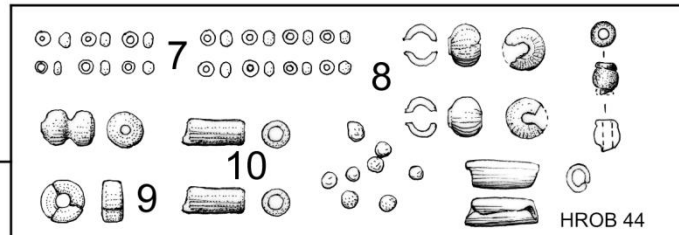
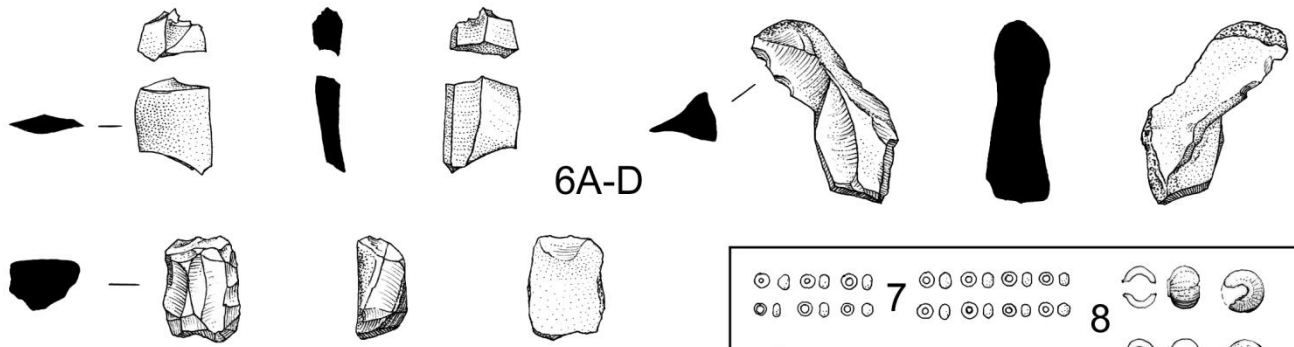
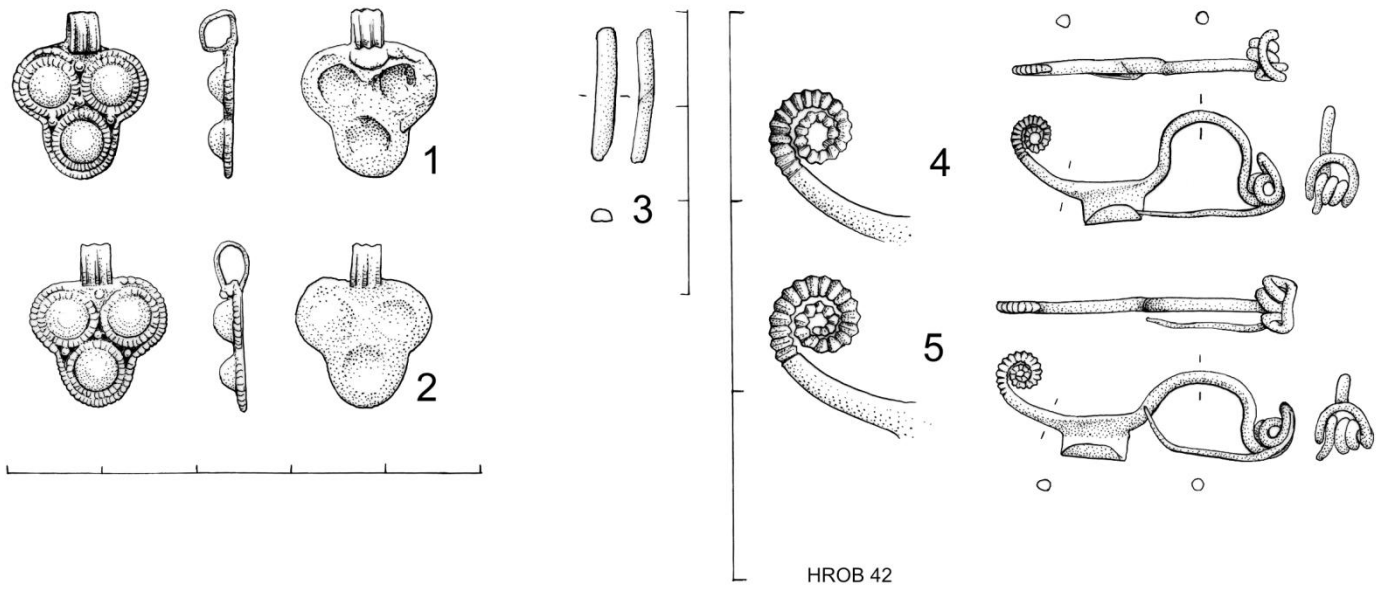

TABULKA 10

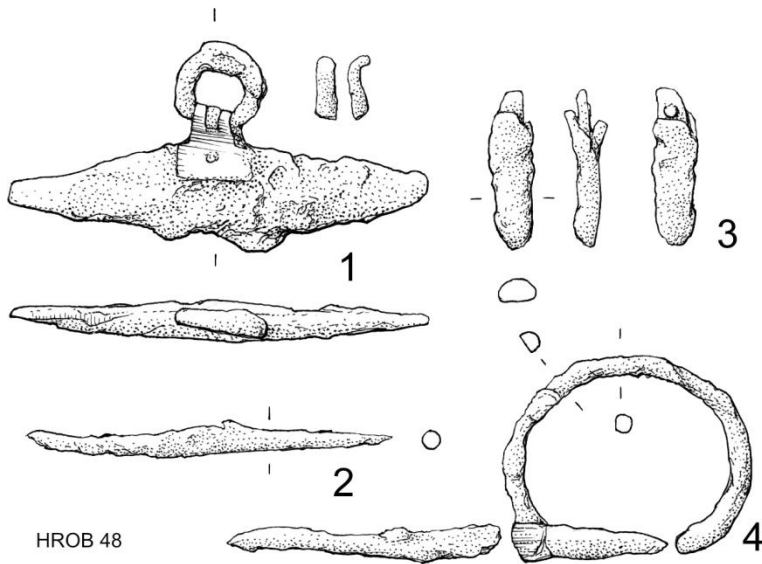

HROB 48

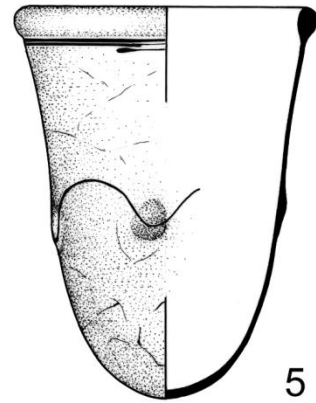

HROB 49



6



7

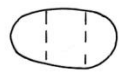

HROB 52

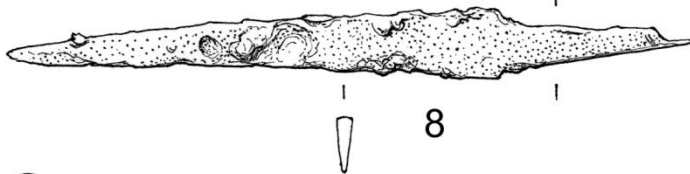

8

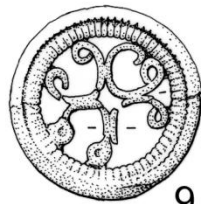

9

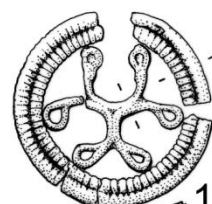

10

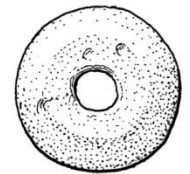

11

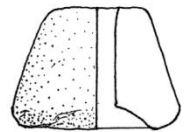

12

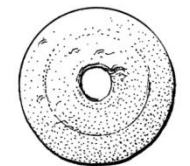

13

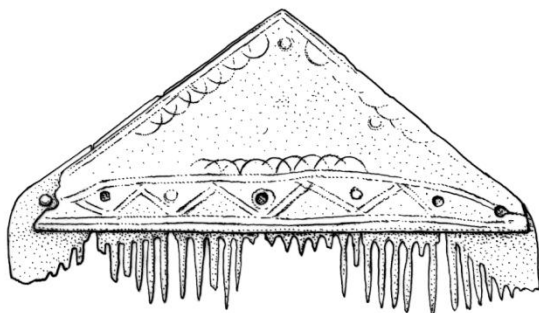

HROB 54

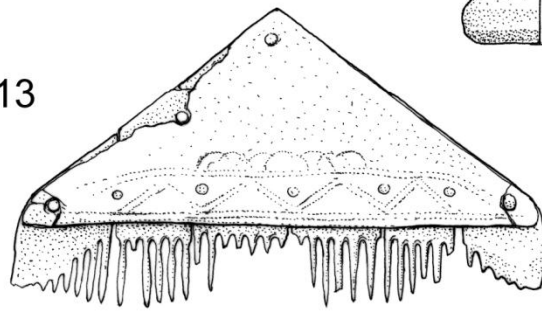

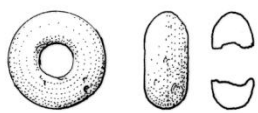

1

HROB 55



2

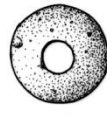

3

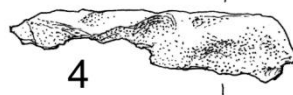

4

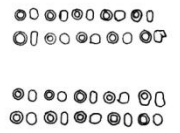

6

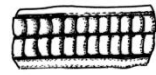

5

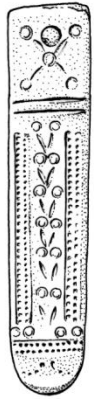

9

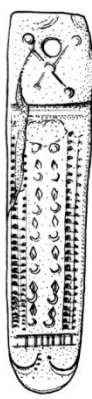

10

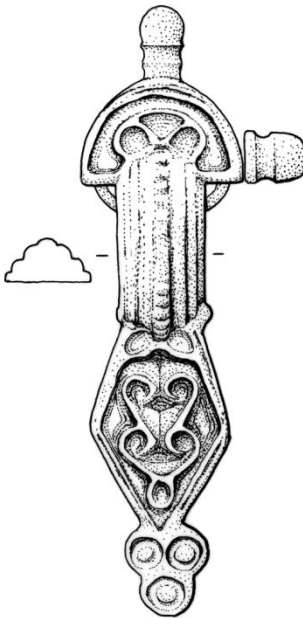

7

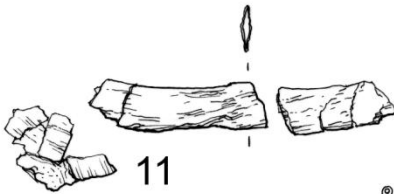
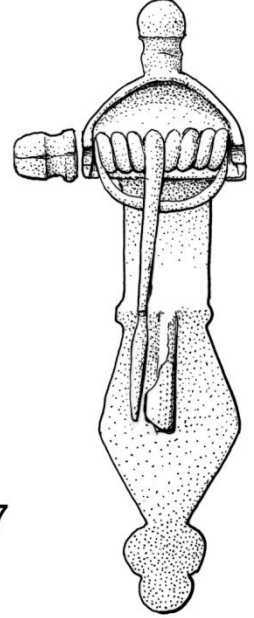
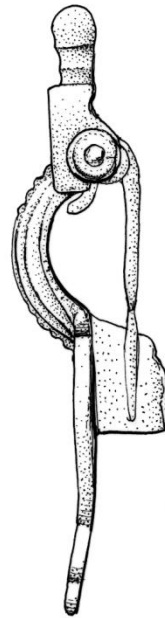

11



12

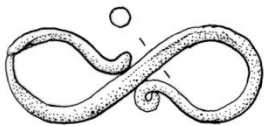

13

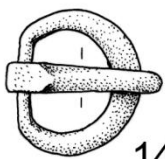

14

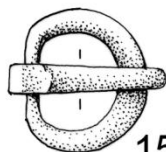

15

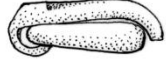

HROB 58

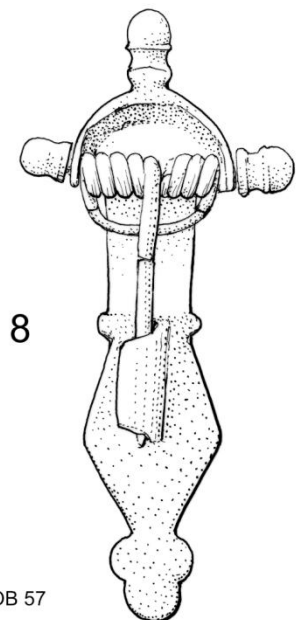
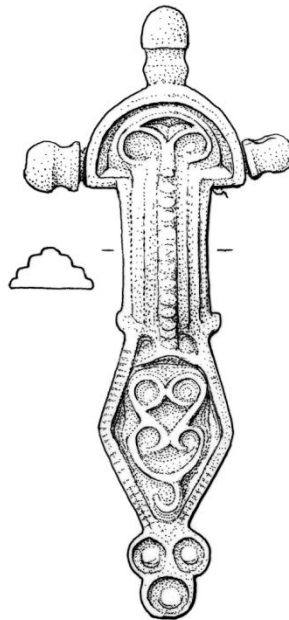

8

HROB 57

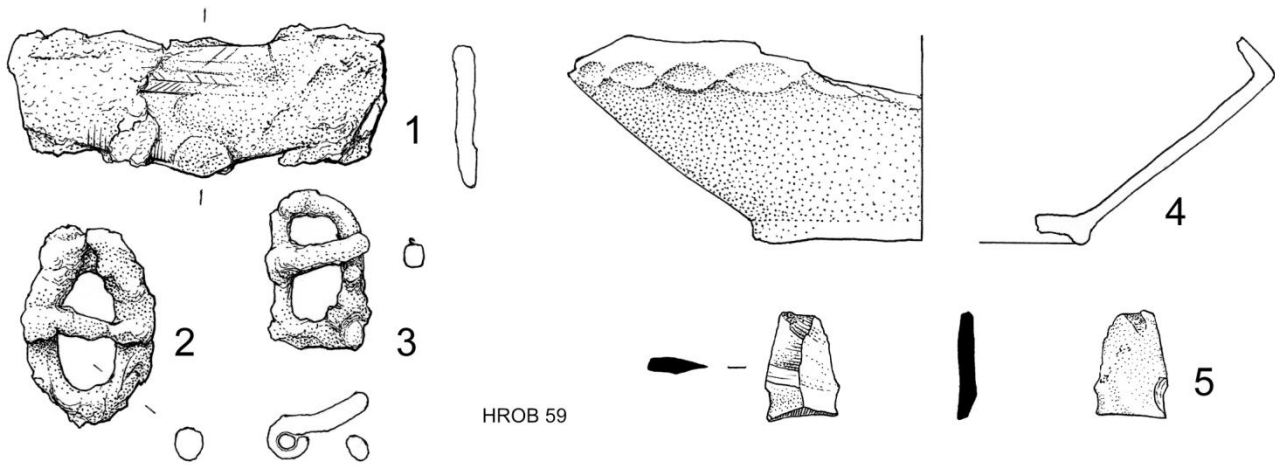

HROB 59



HROB 60



HROB 61

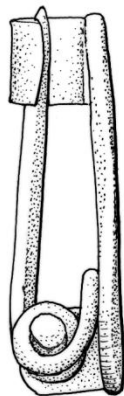

6

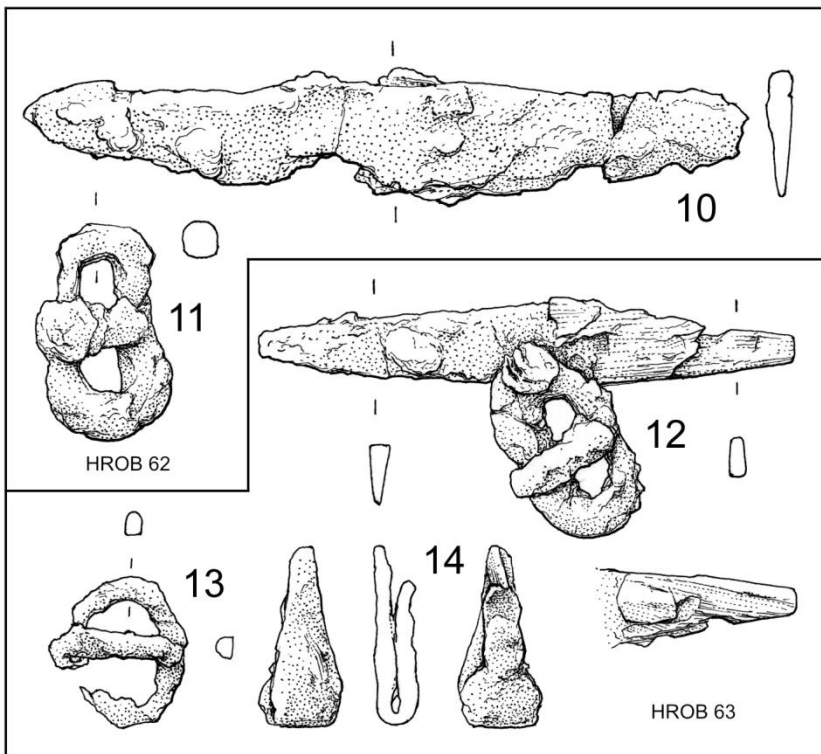
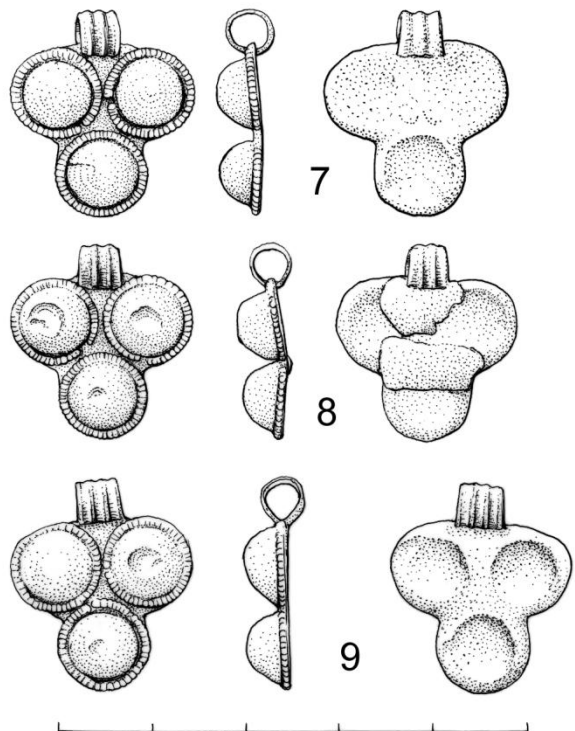

HROB 62

HROB 63

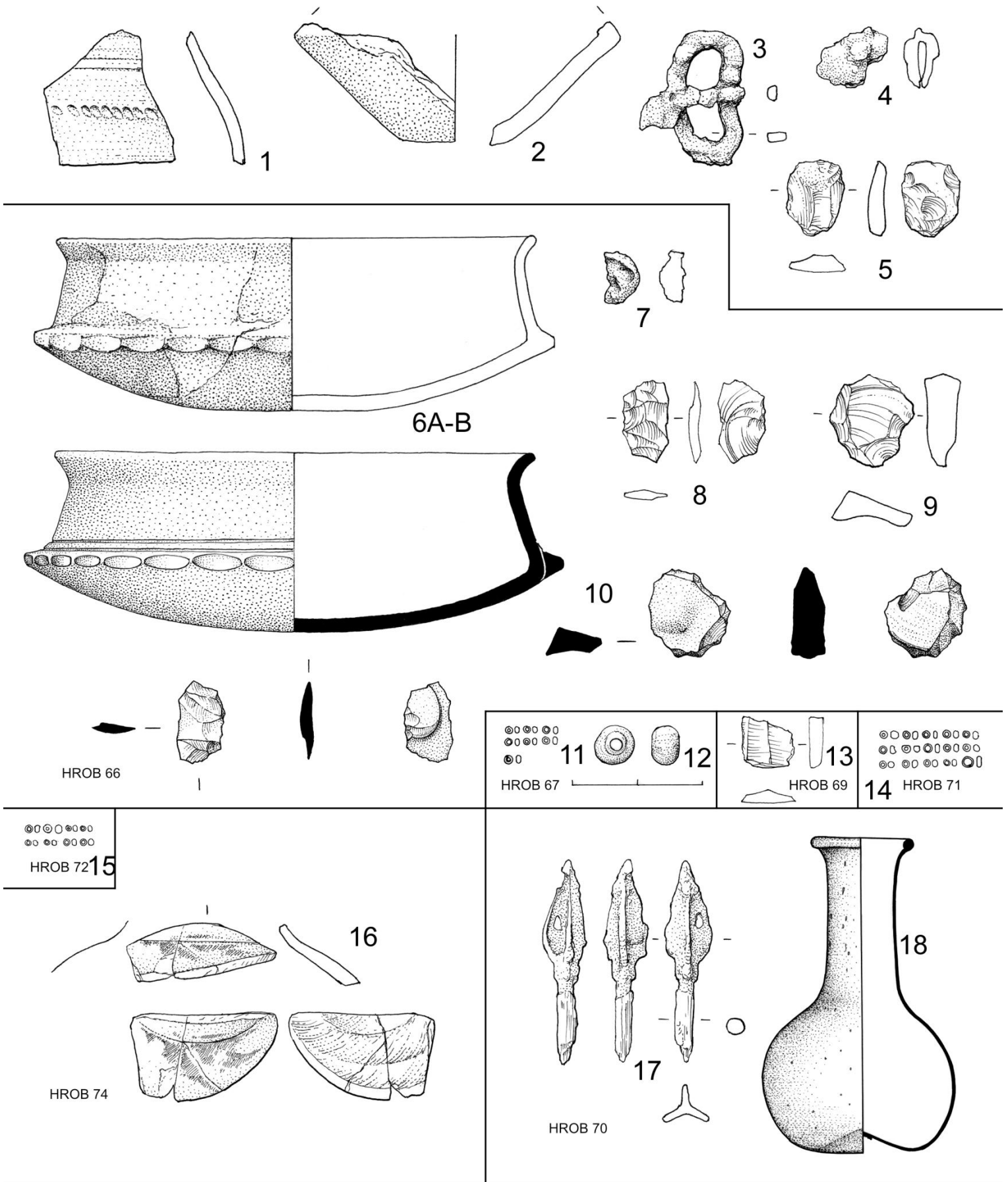

TABULKA 14

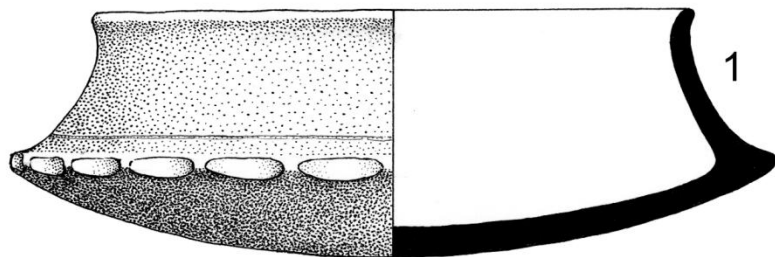

HROB 75

⊙ ⊙ ⊙ ⊙

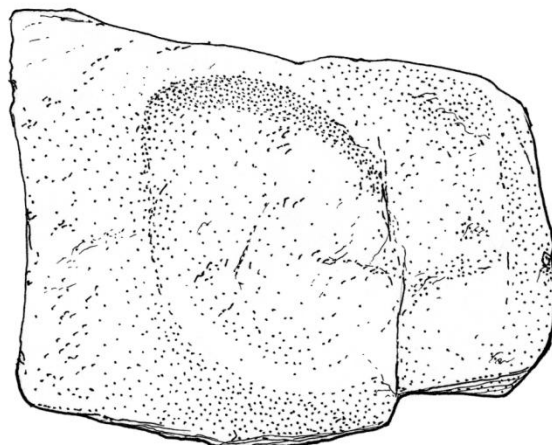

2



HROB 76

3

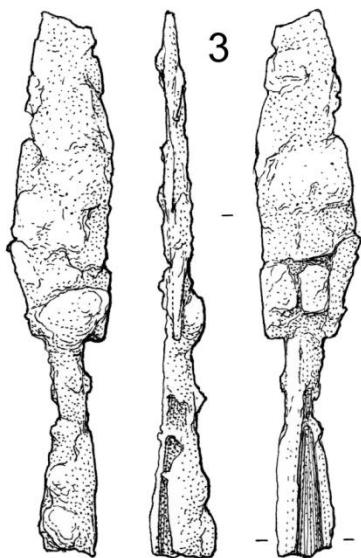

4

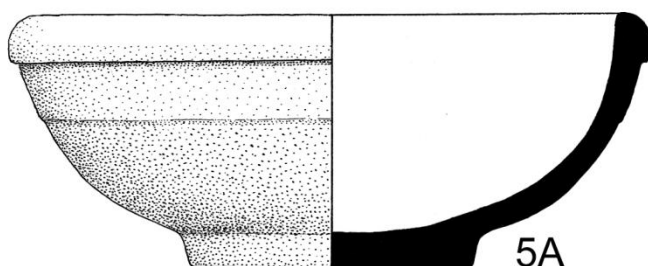
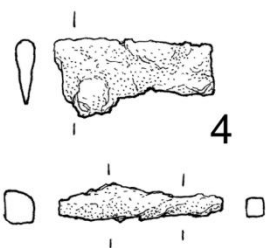

5A

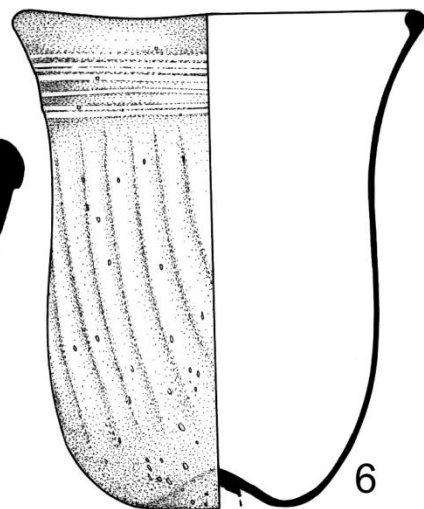

6

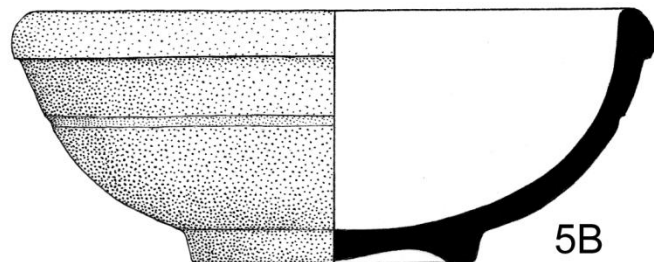

5B

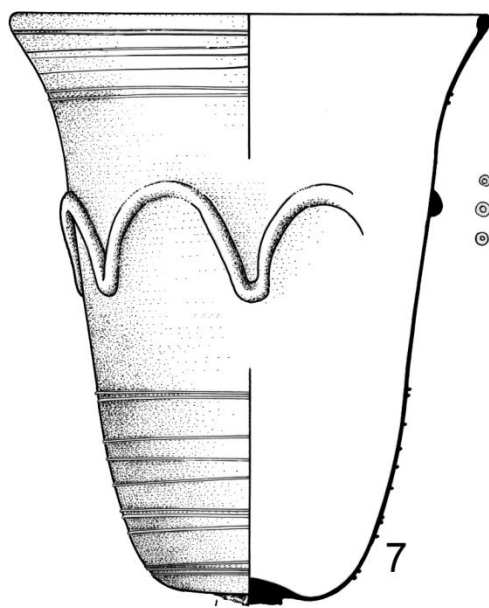

7

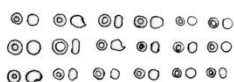

8

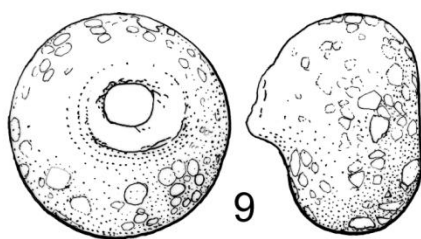

9

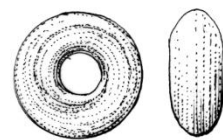

10

HROB 78

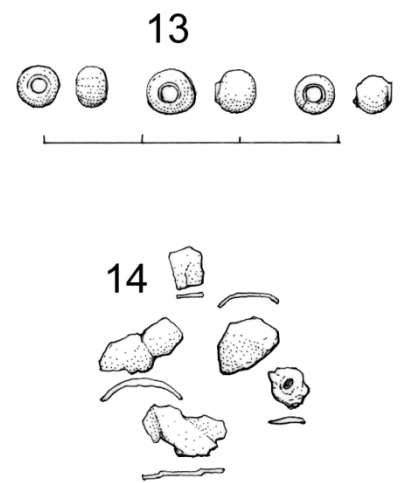
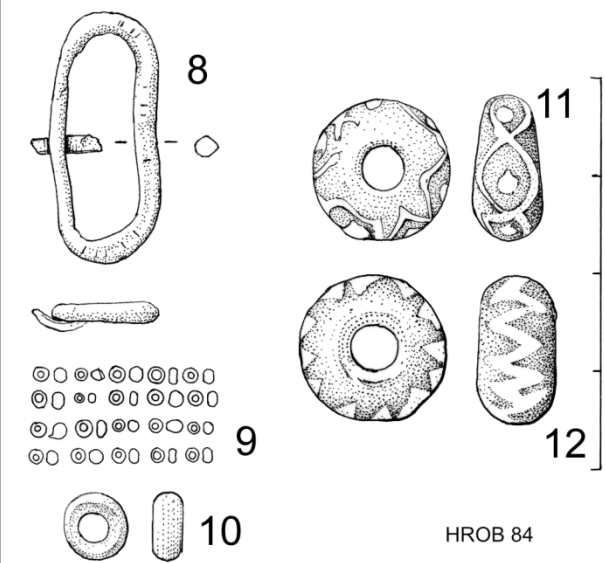
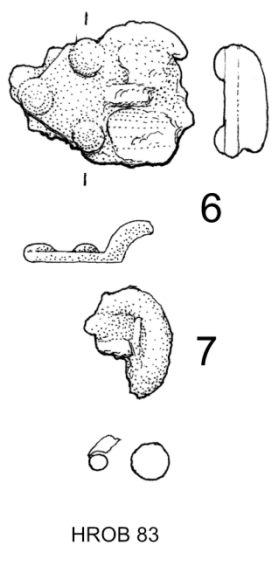
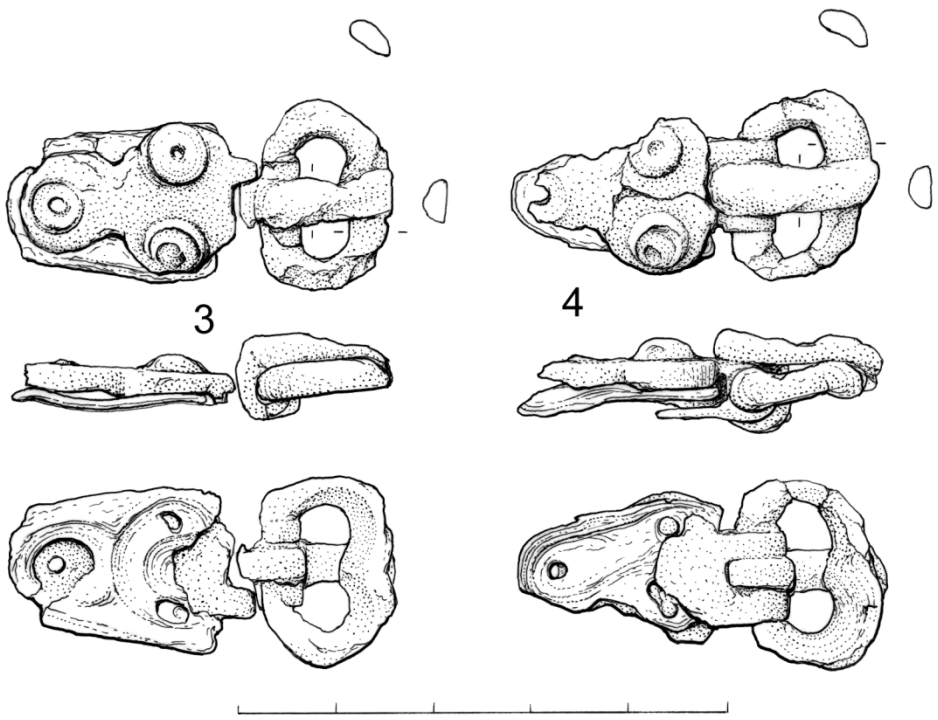
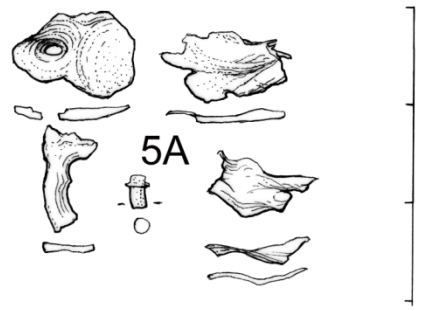
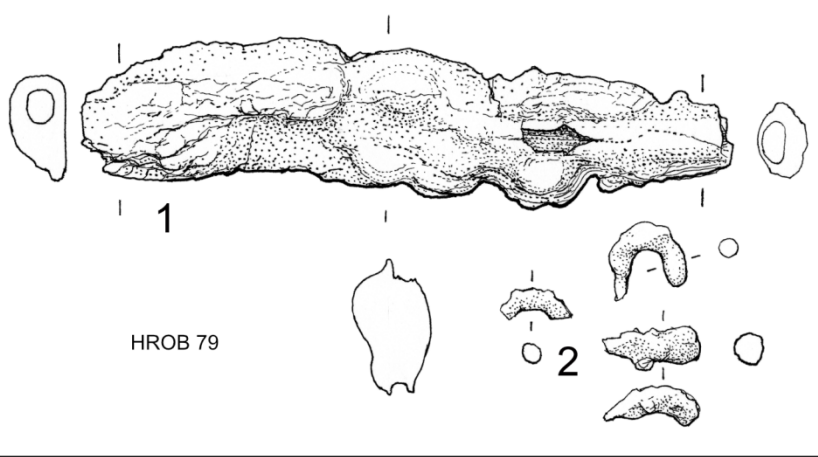

TABULKA 16

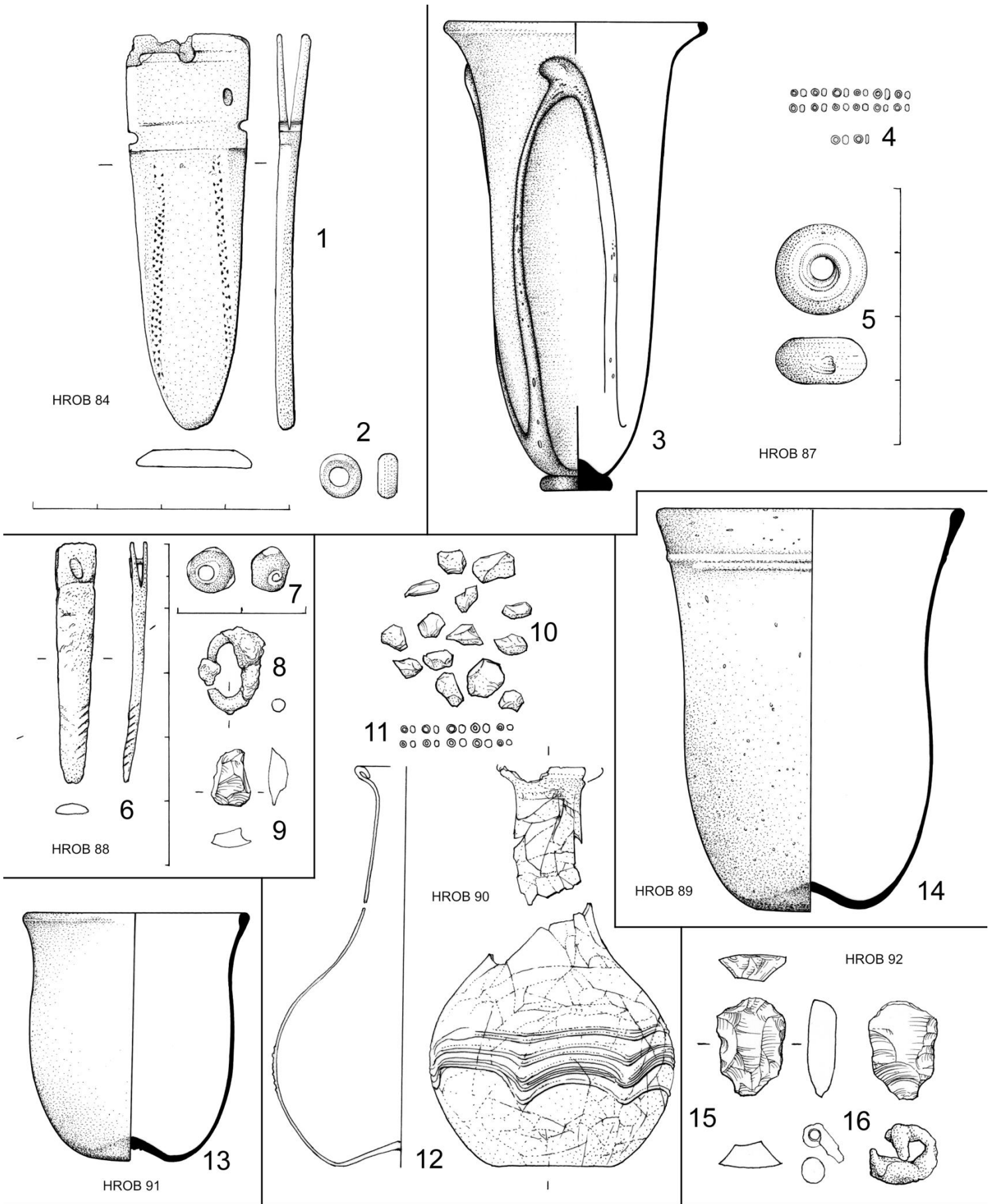

TABULKA 17

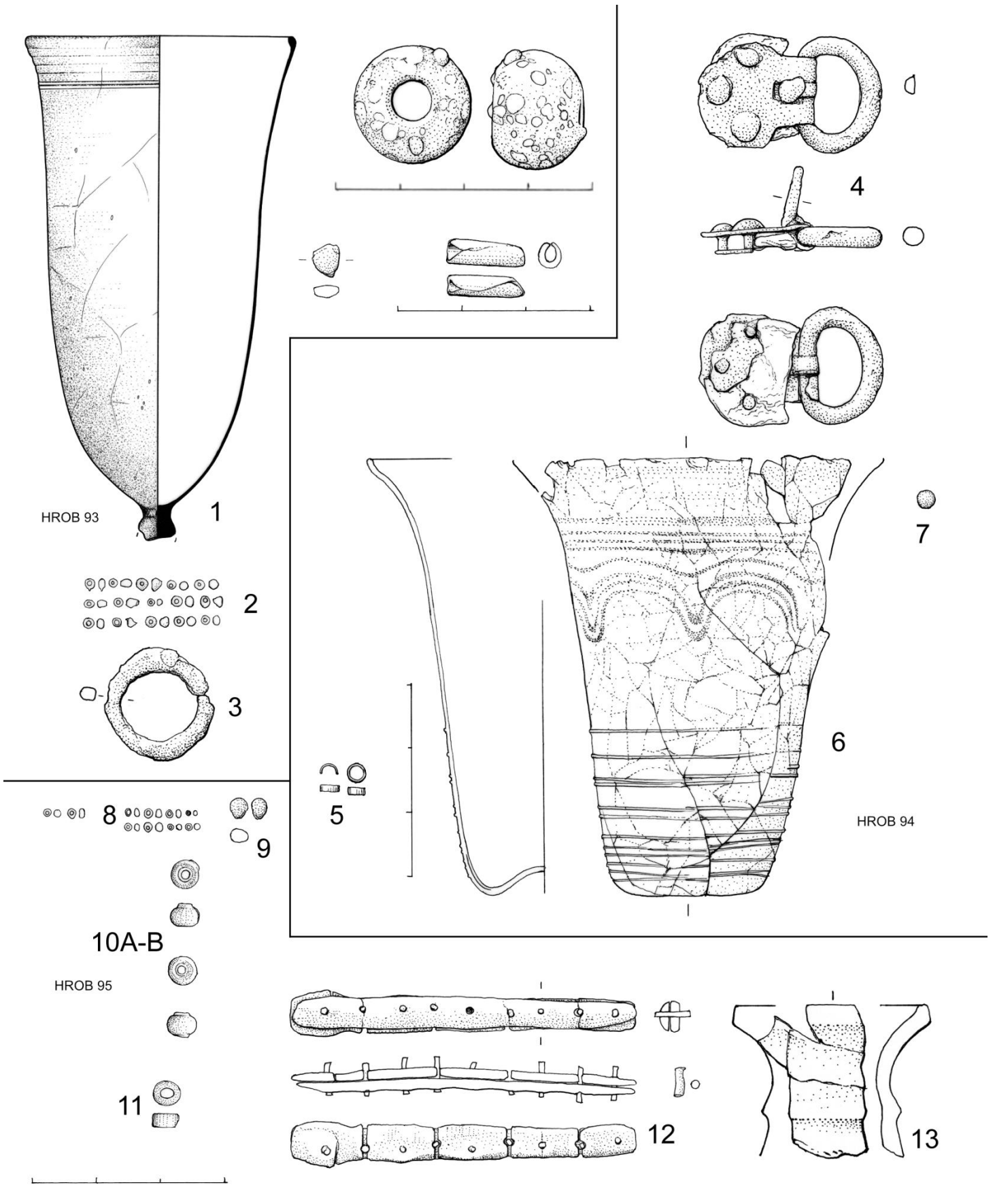

TABULKA 18

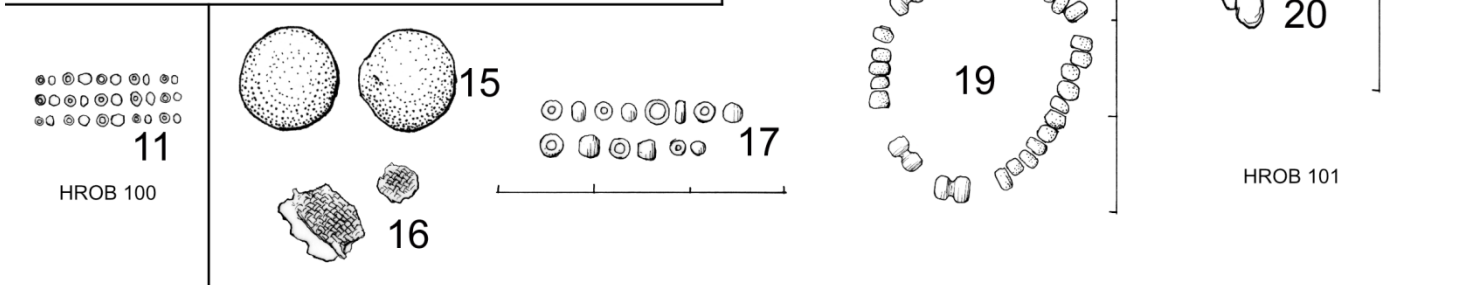
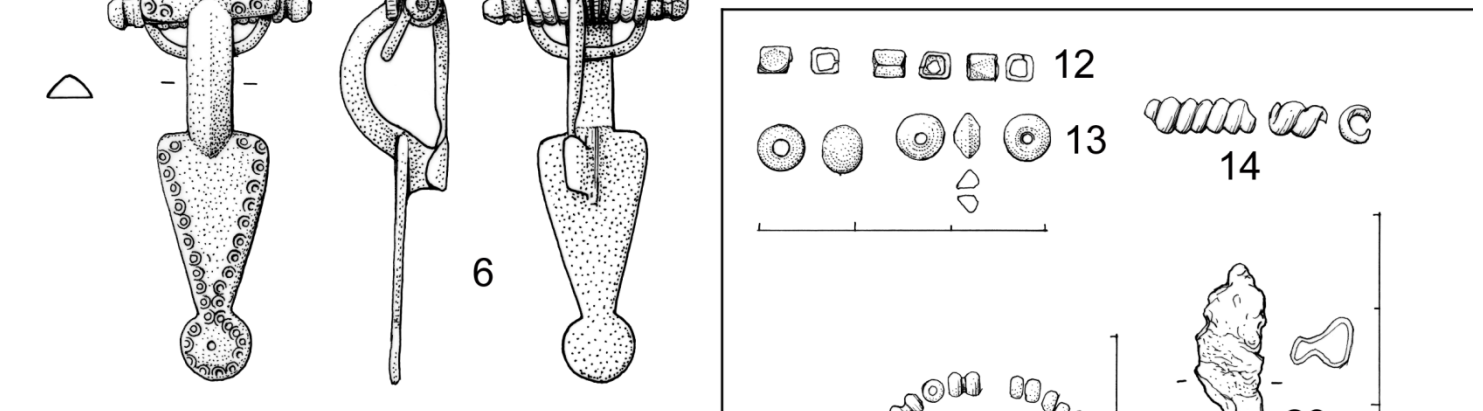
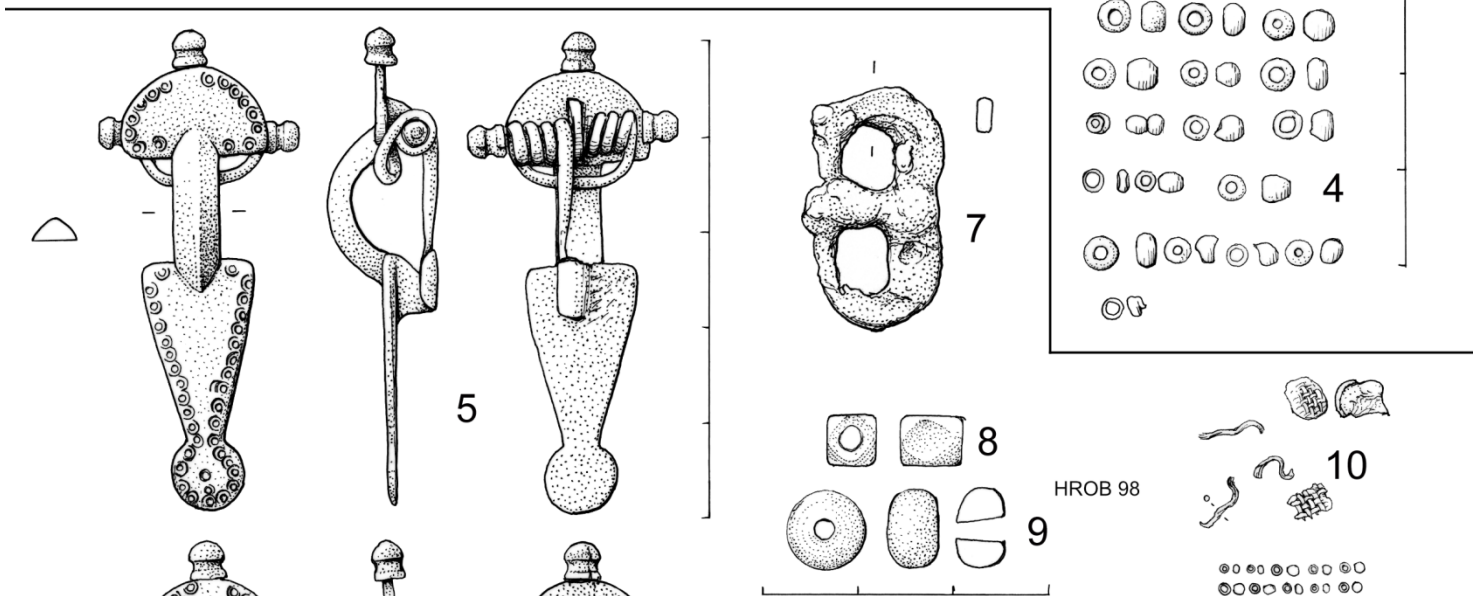
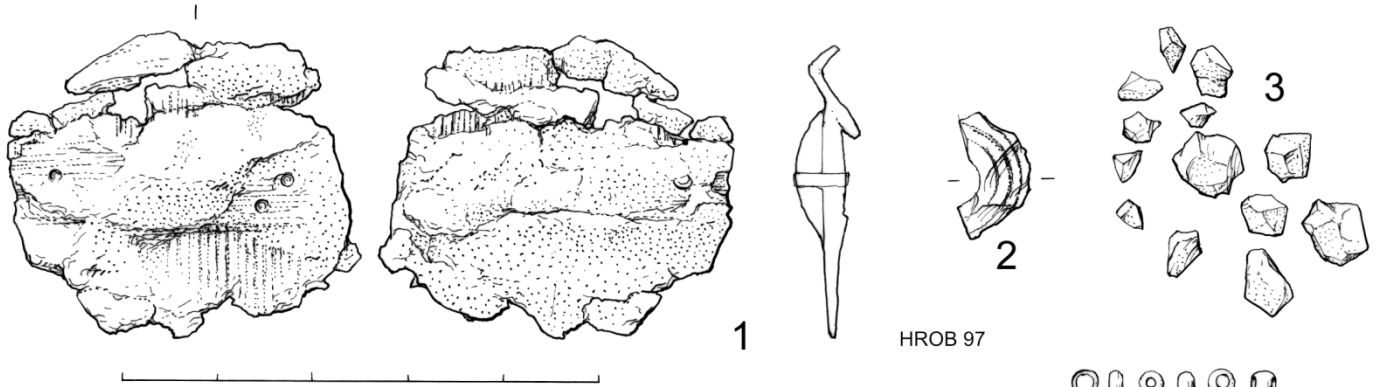

TABULKA 19

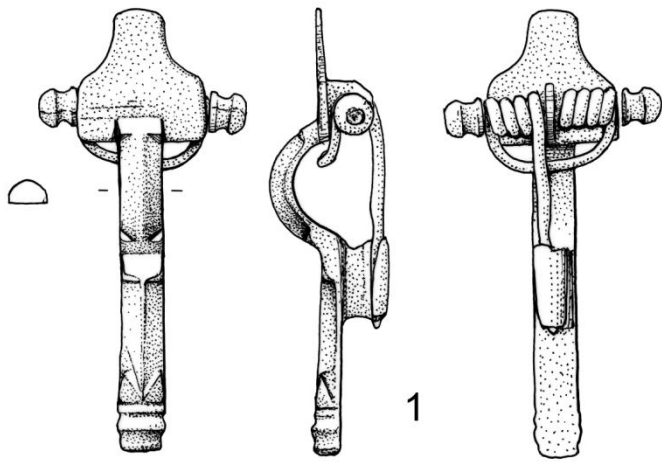

1

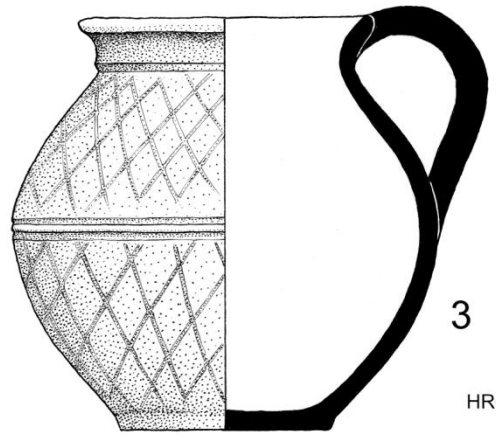

3

HROB 101

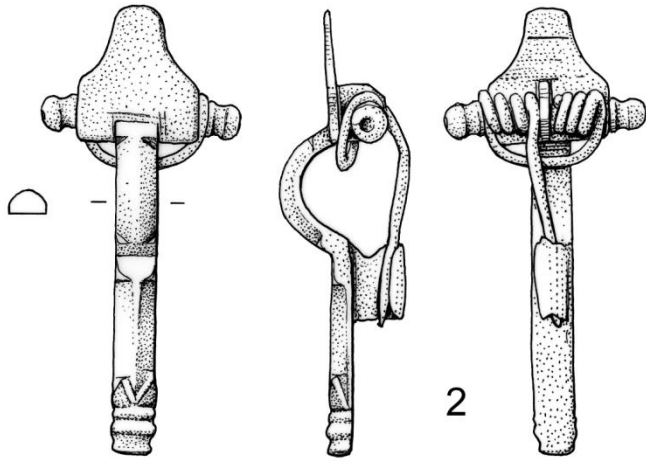

2

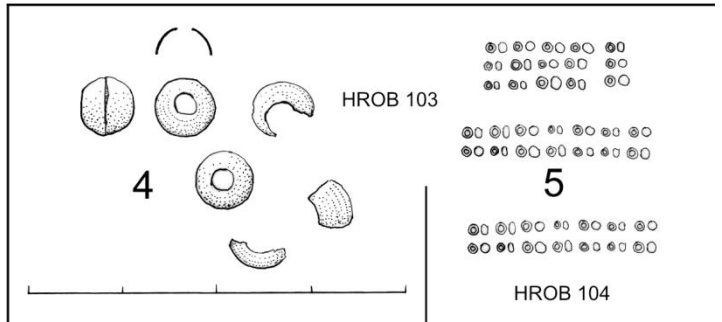

HROB 103

4

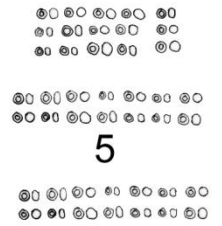

5

HROB 104

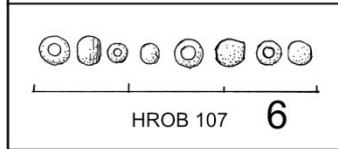

HROB 107

6

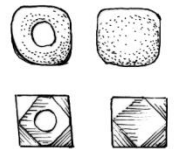

11A-B



8

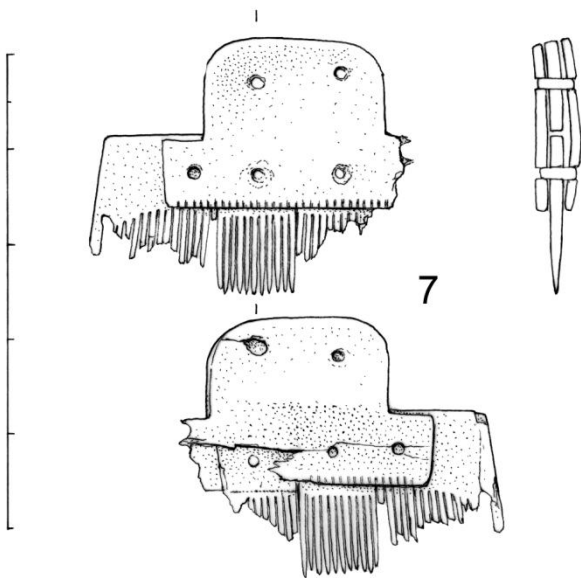

7



9A-B

12

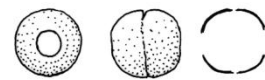
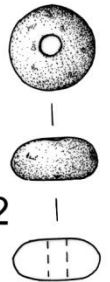

13B

13A

HROB 108

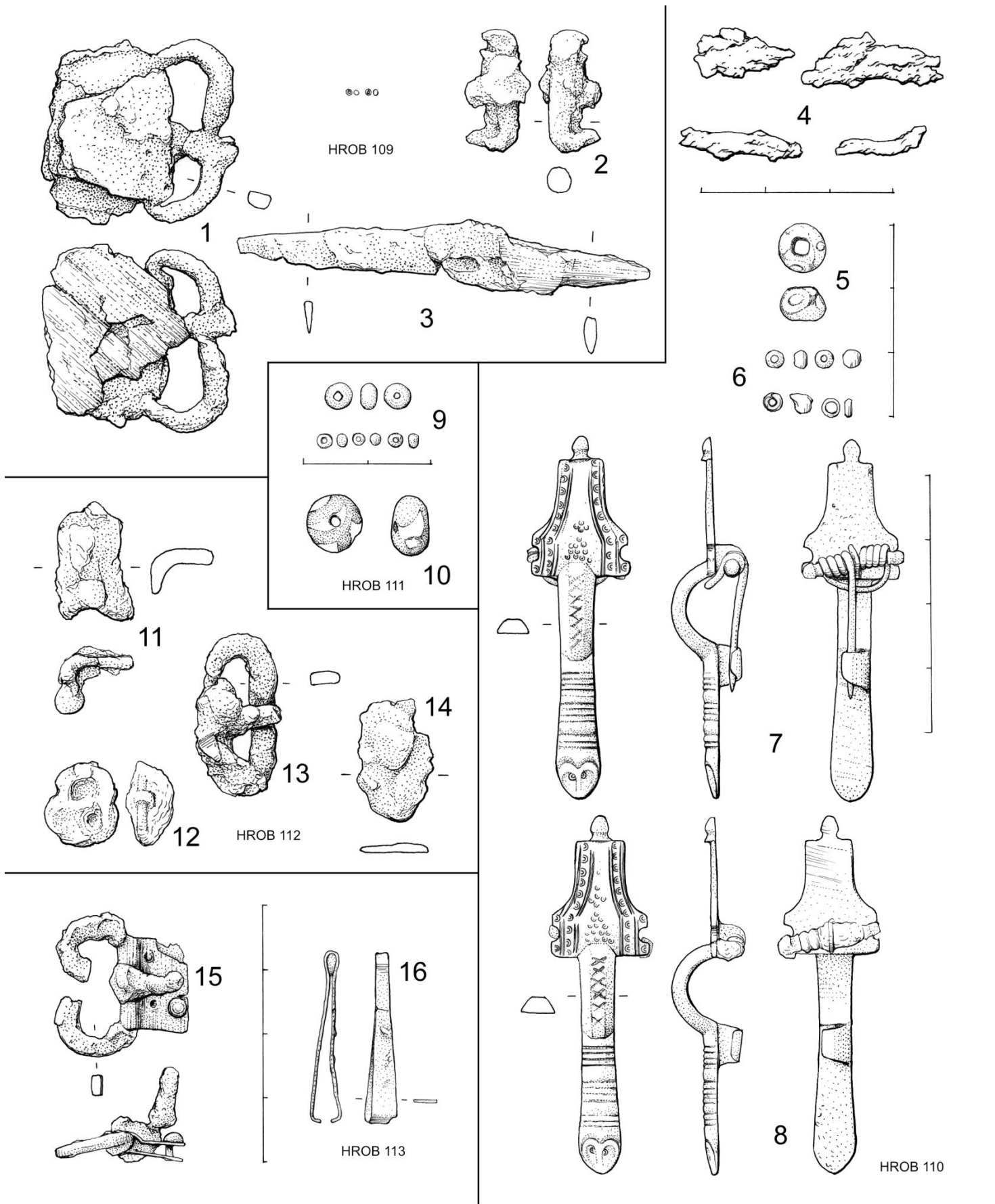

TABULKA 21

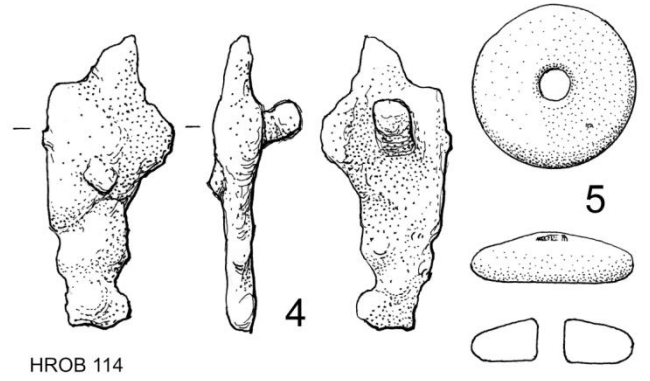
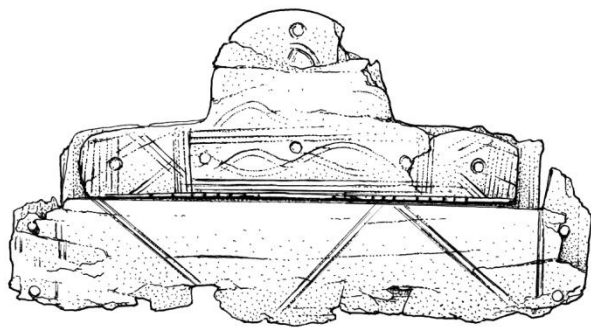

HROB 114

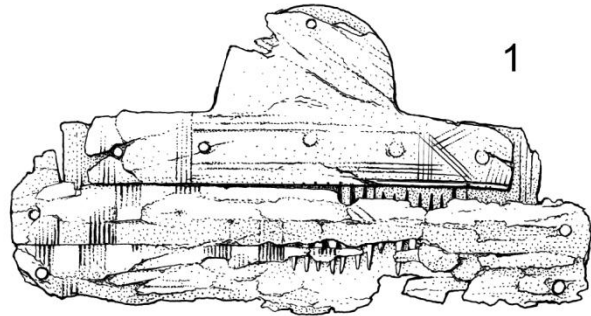

1

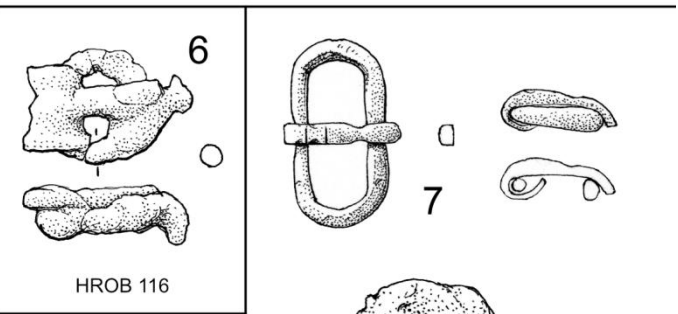

HROB 116

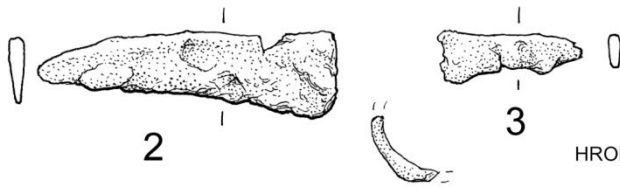

HROB 113

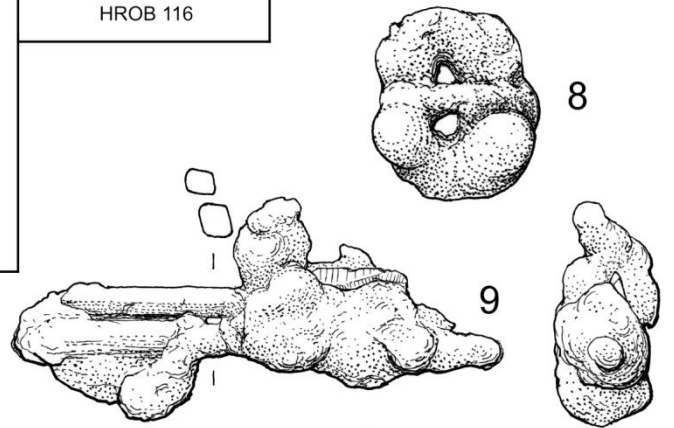

HROB 117

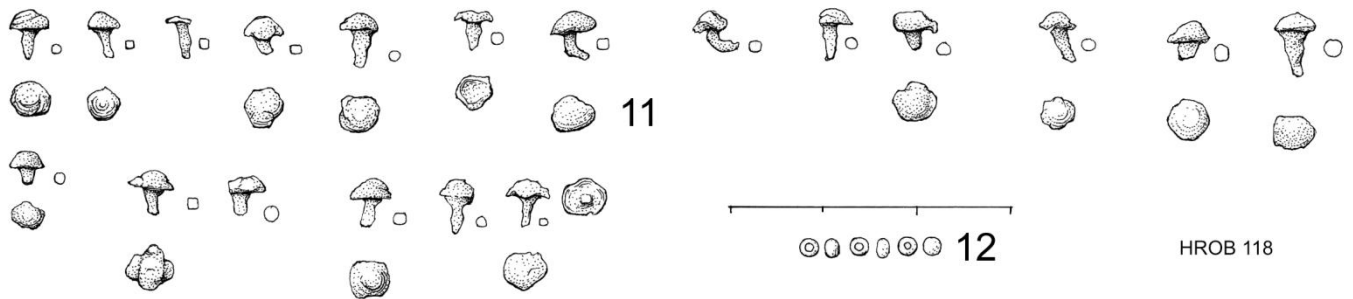
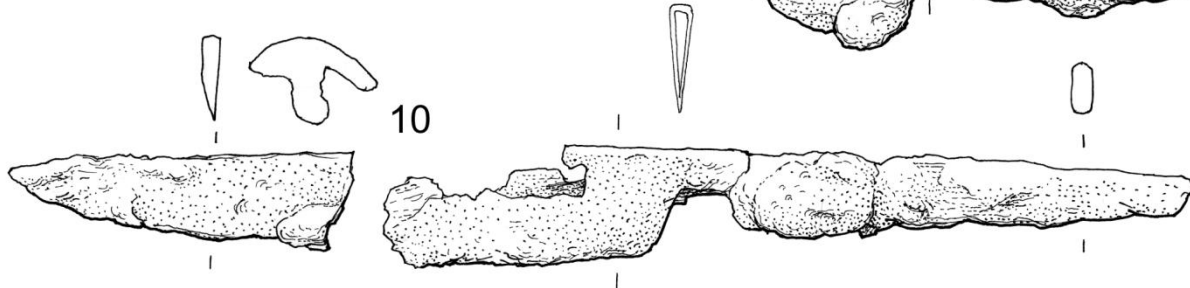

HROB 118

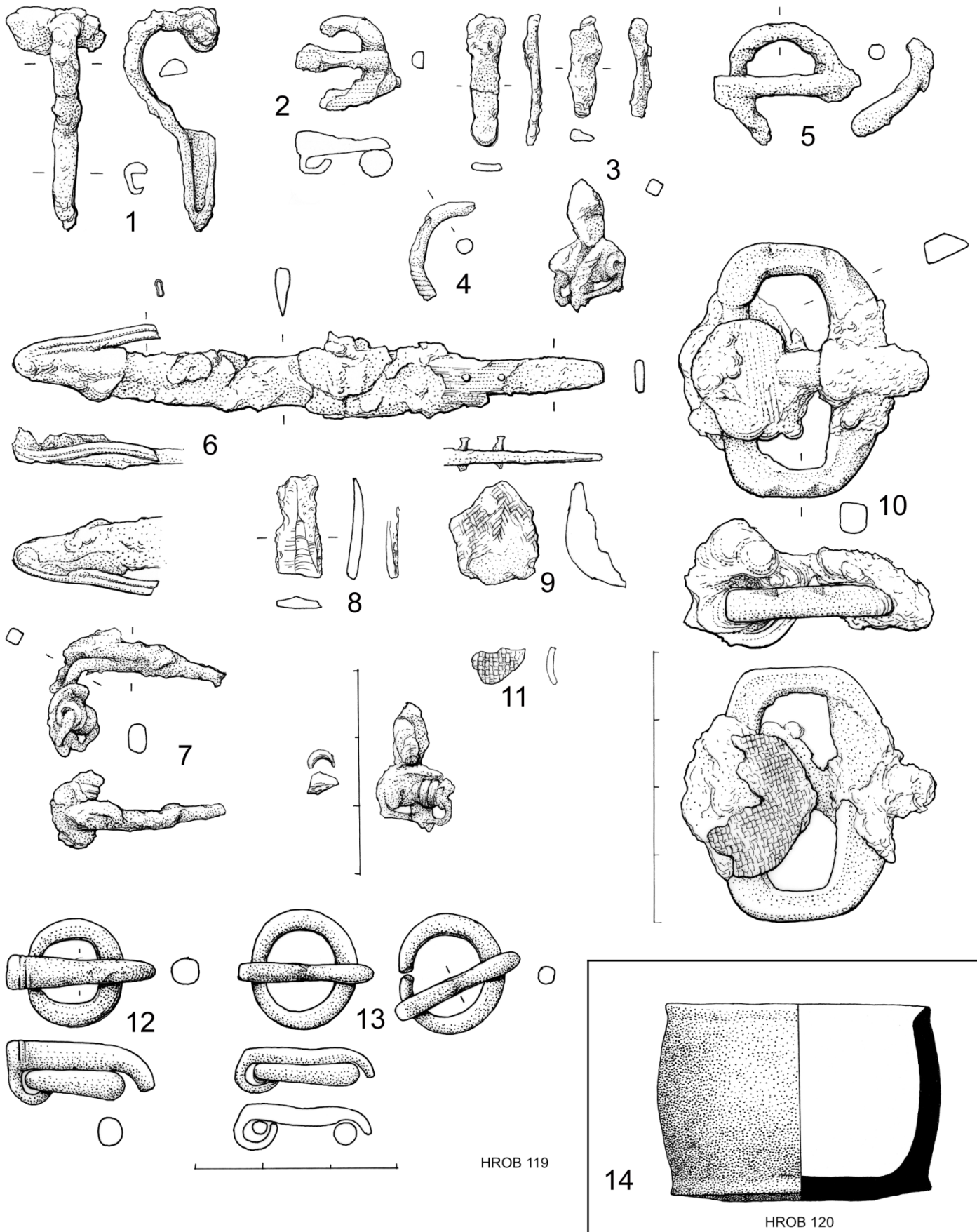

TABULKA 23

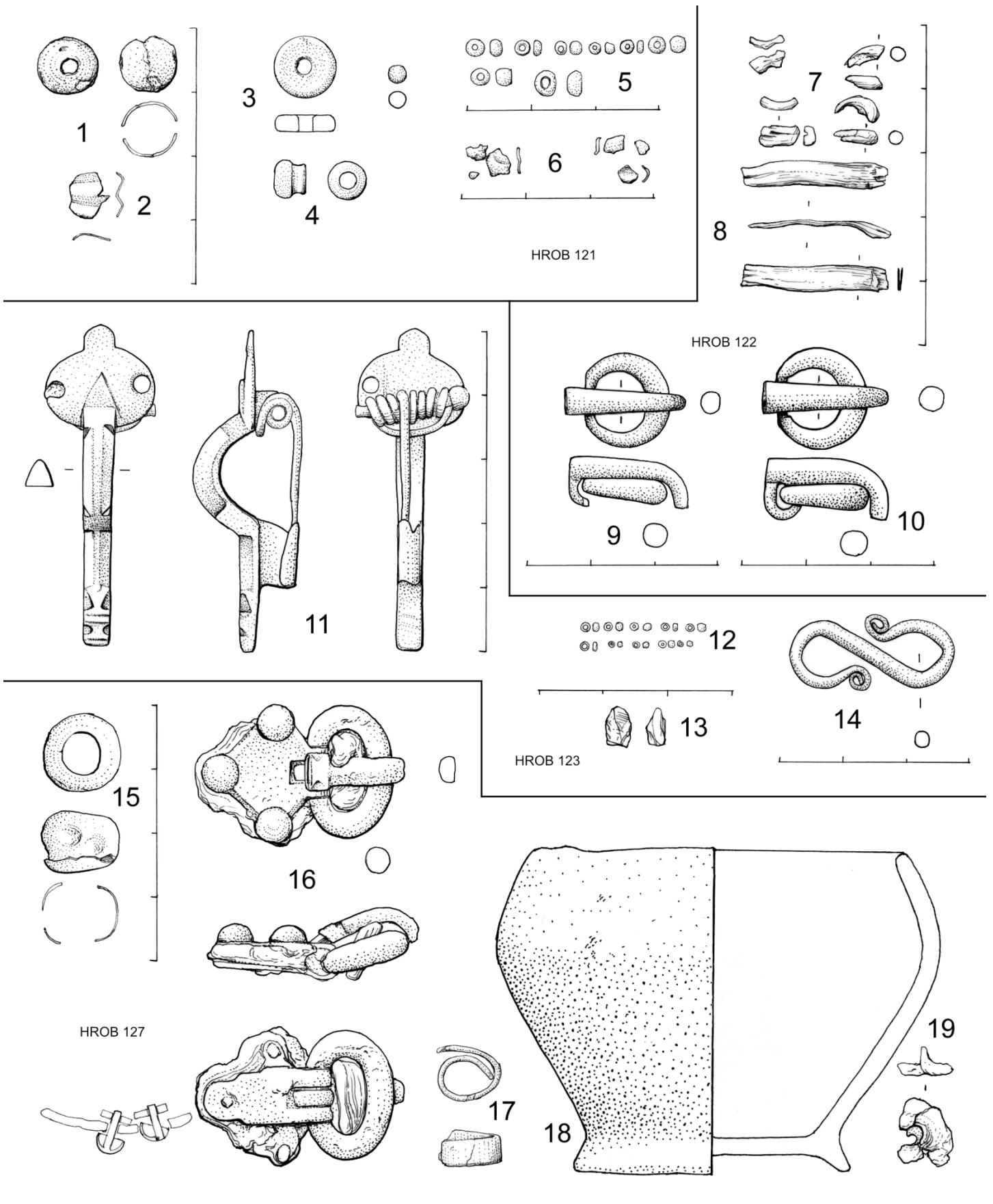

TABULKA 24

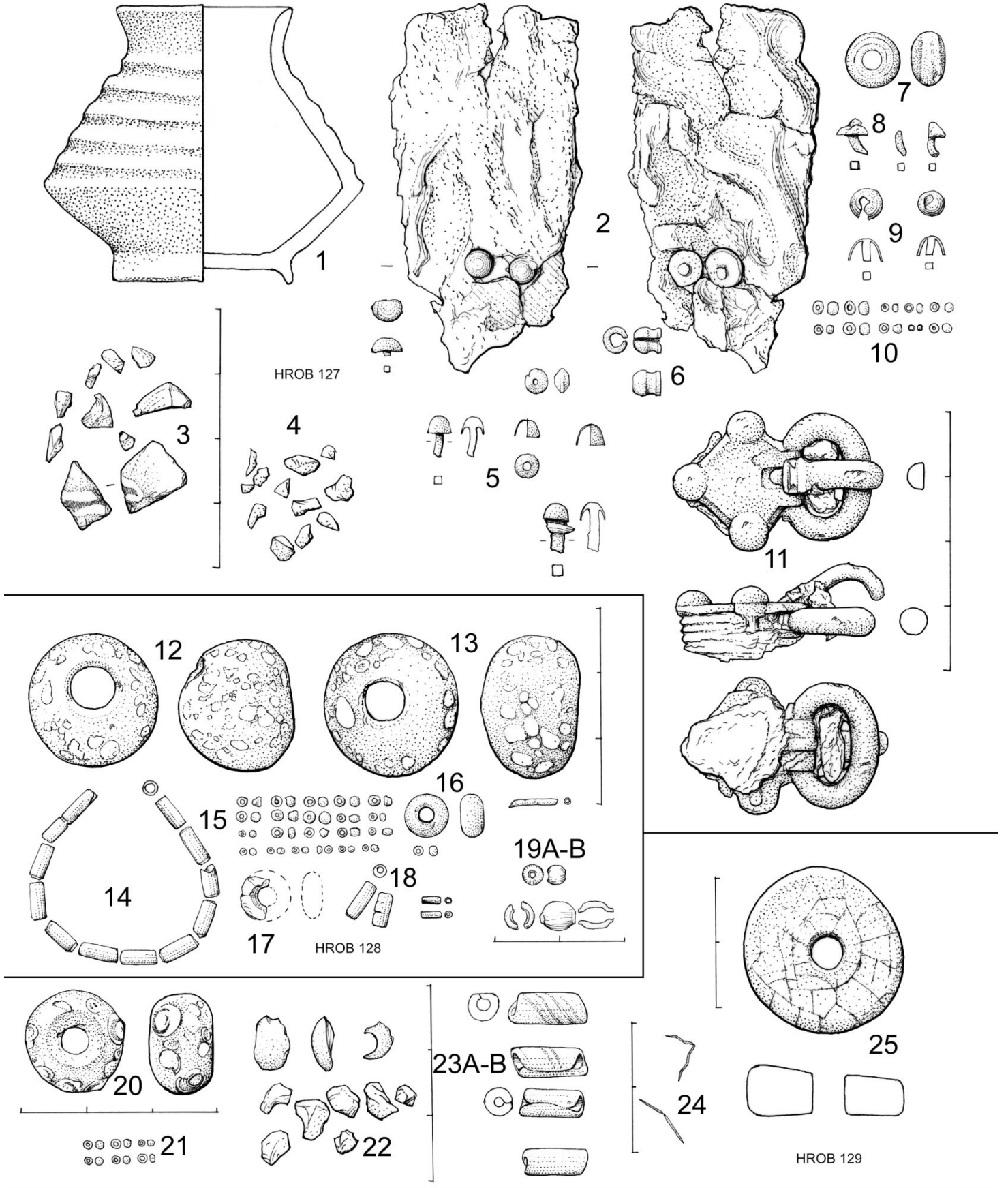

TABULKA 25

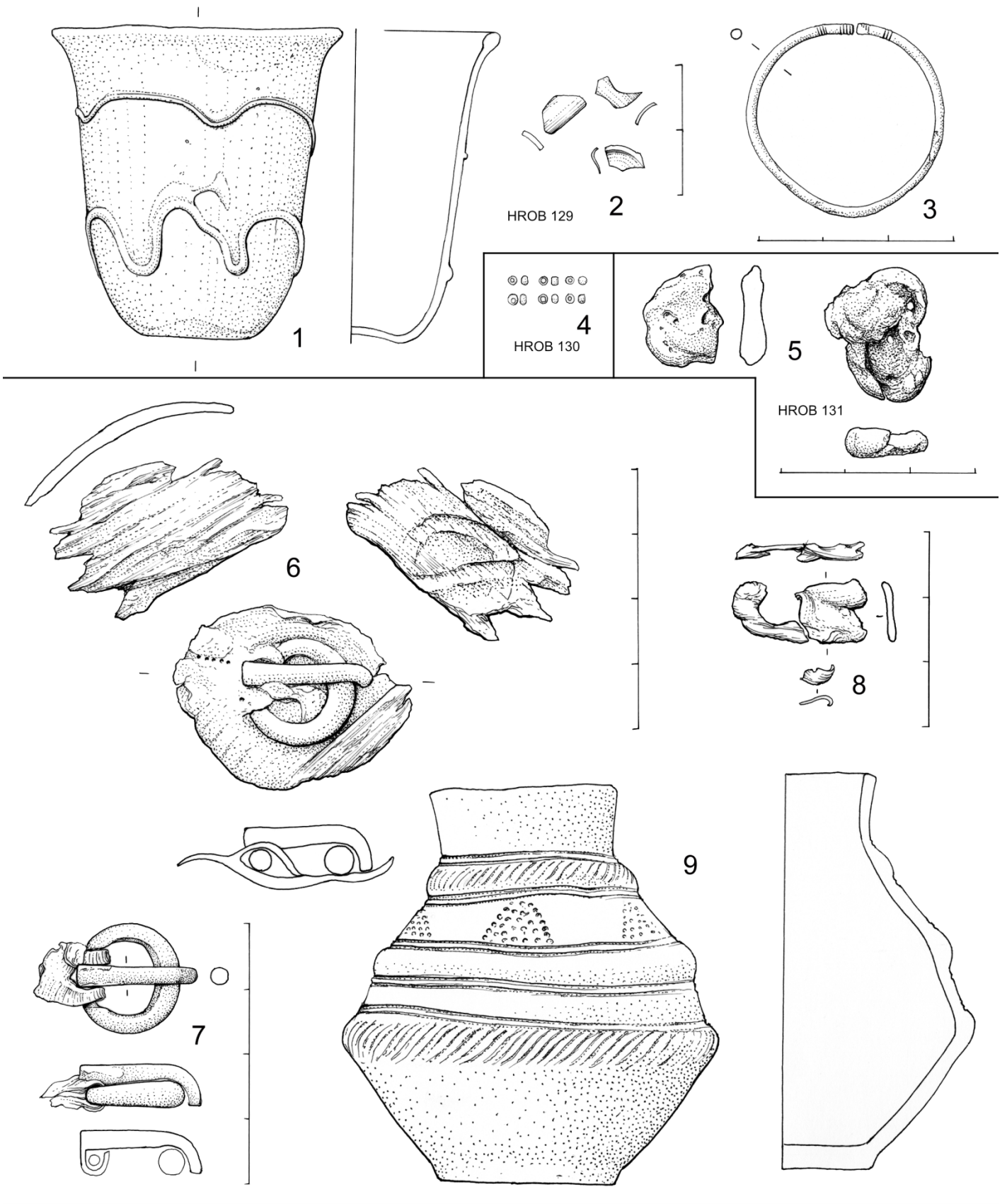

TABULKA 26

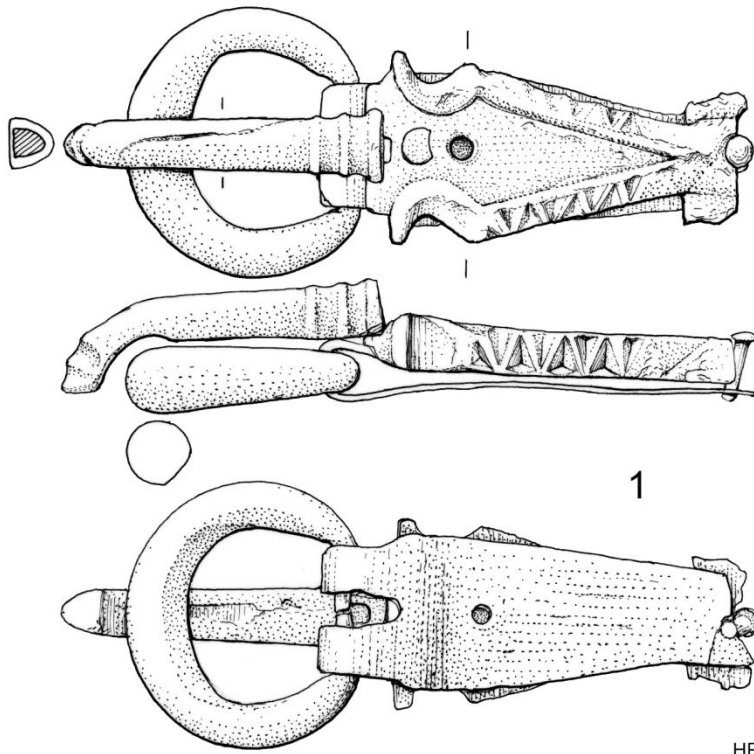

HROB 132

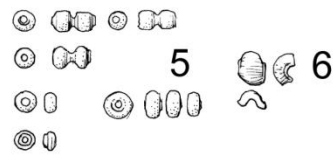
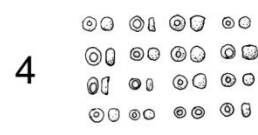
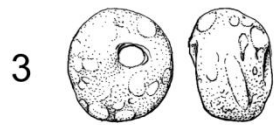
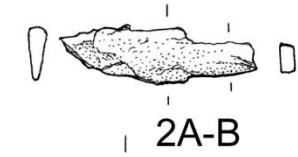
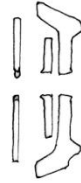

HROB 133

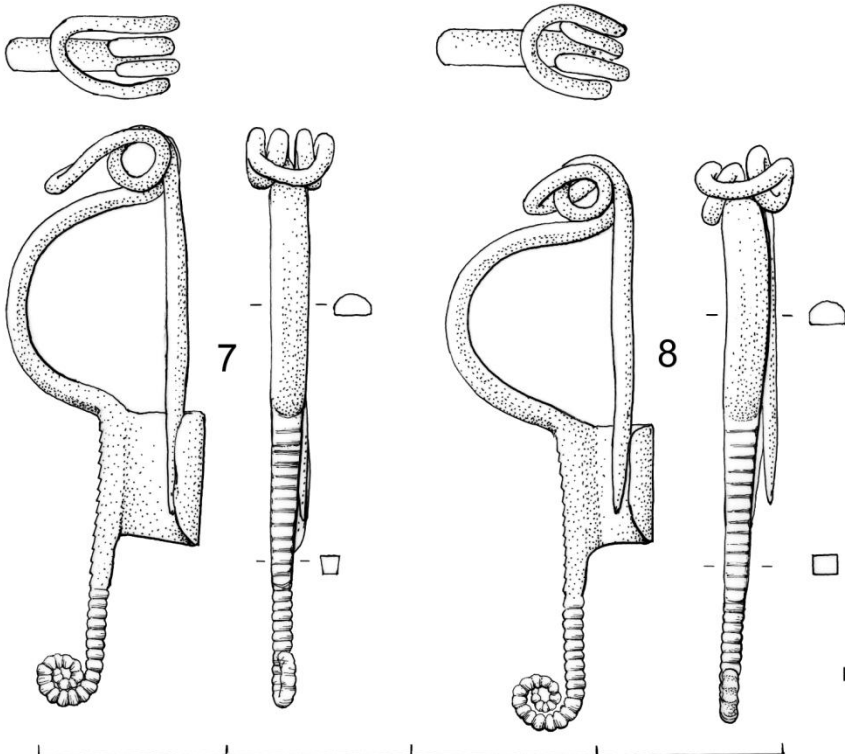

HROB 135

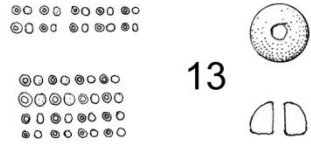
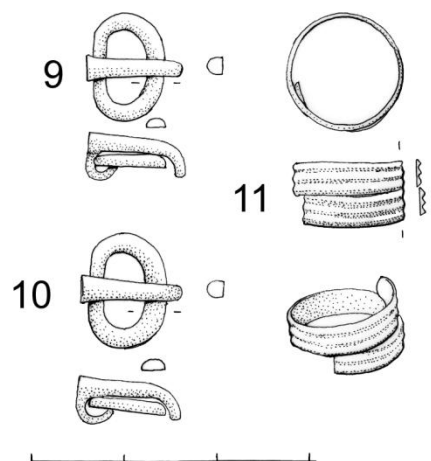

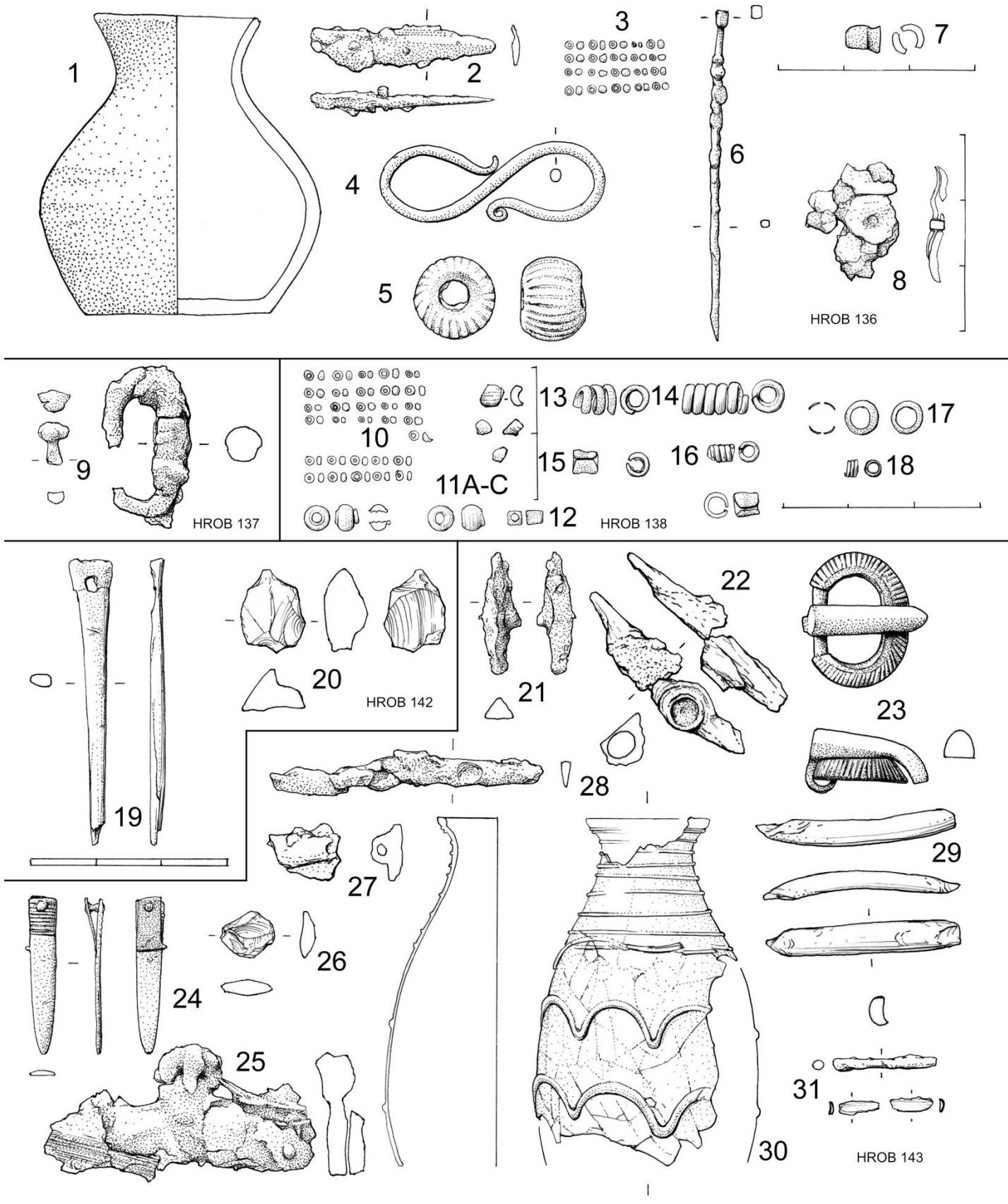

TABULKA 28

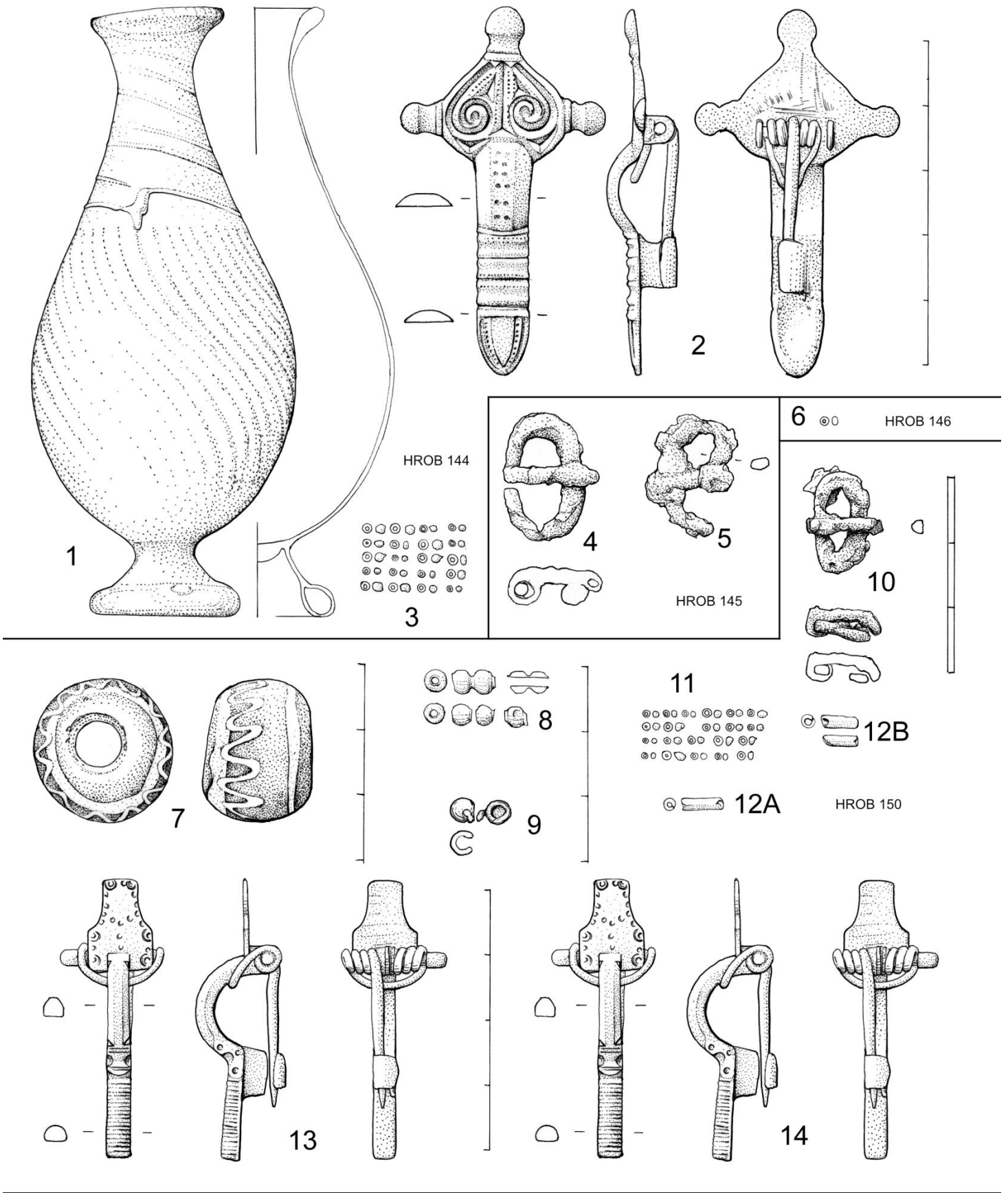

TABULKA 29

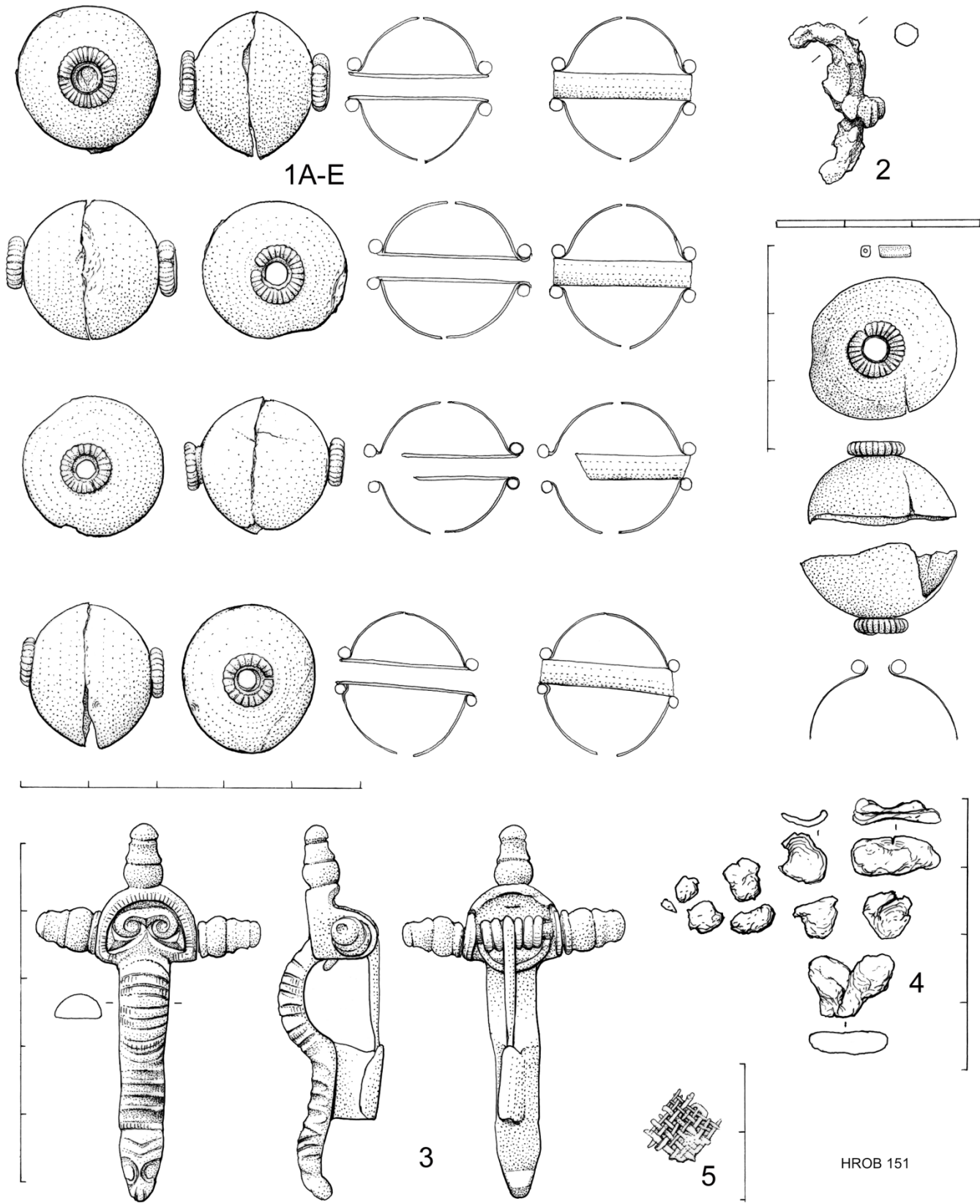

TABULKA 30

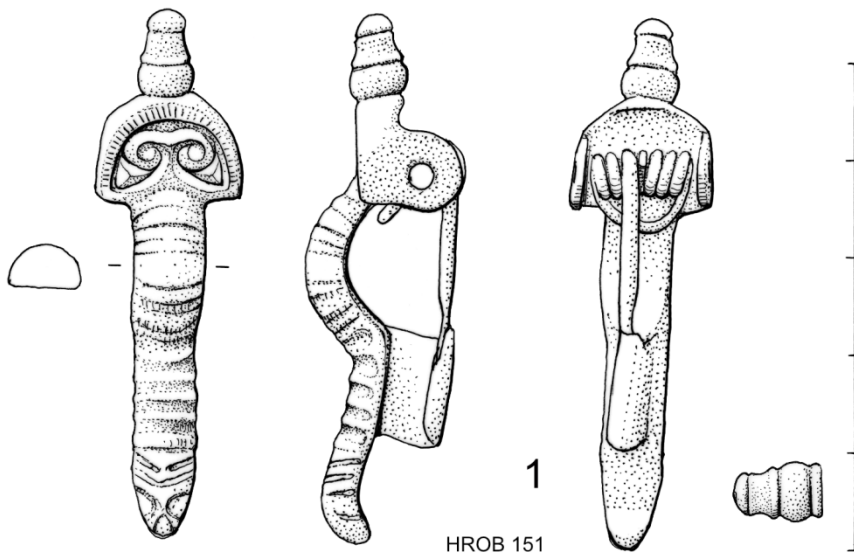

HROB 151

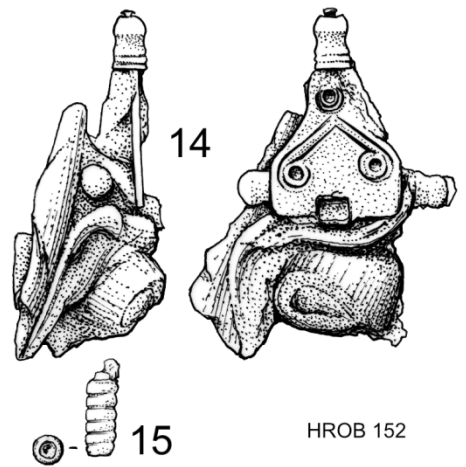
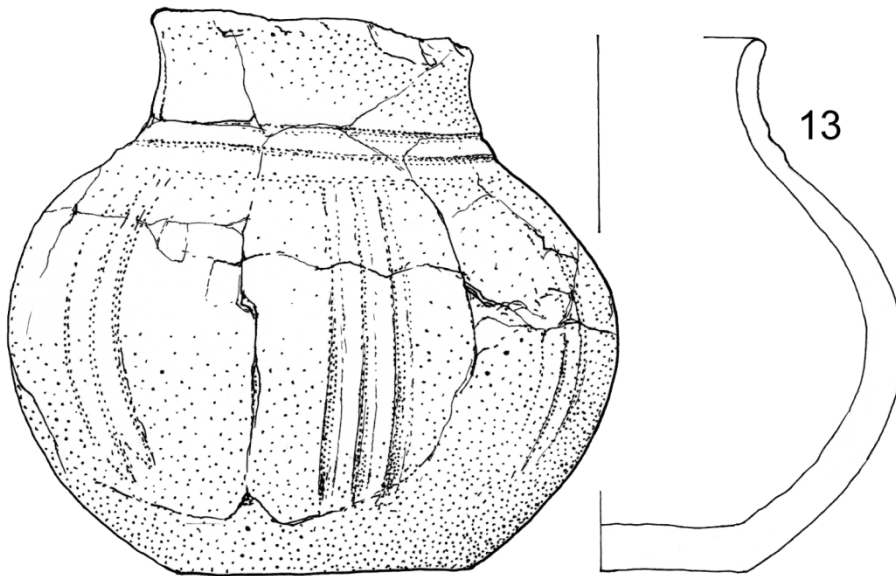
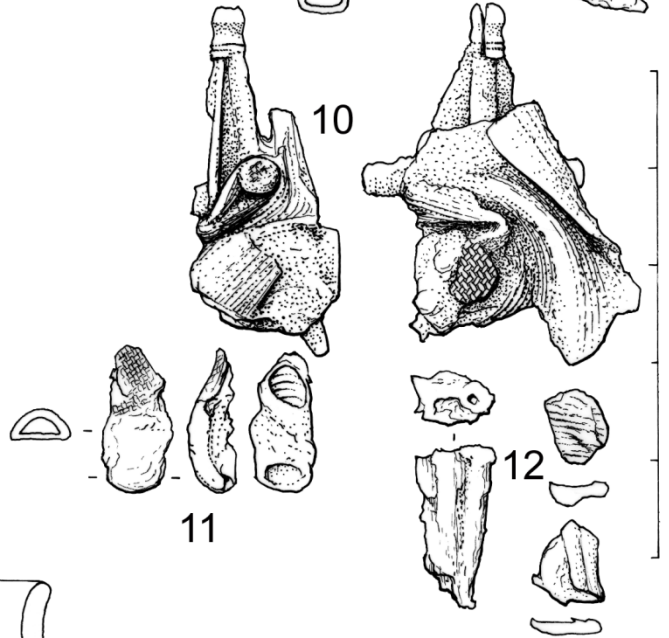
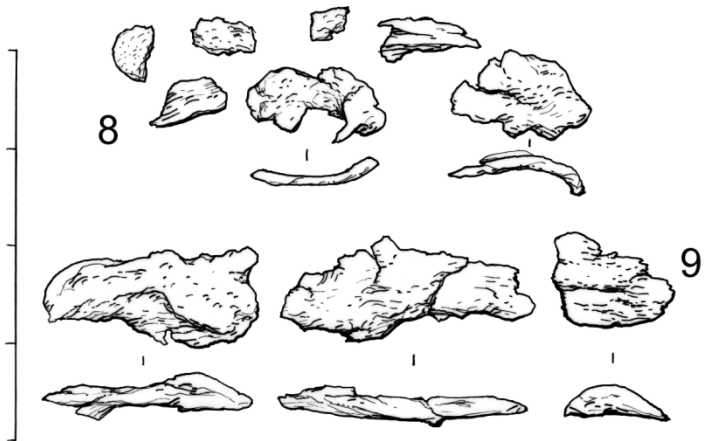
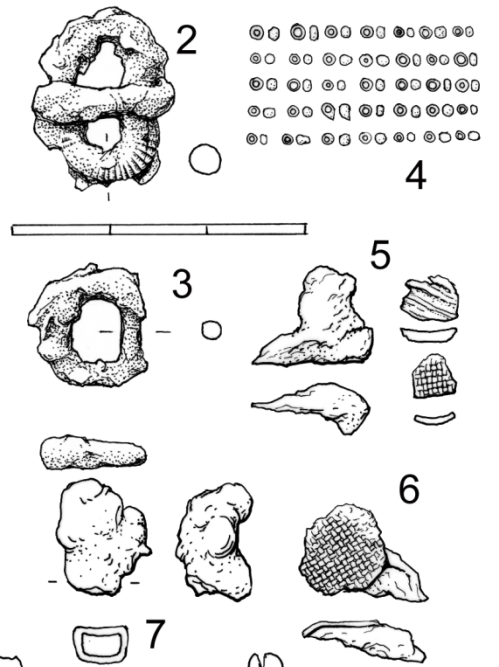

HROB 152

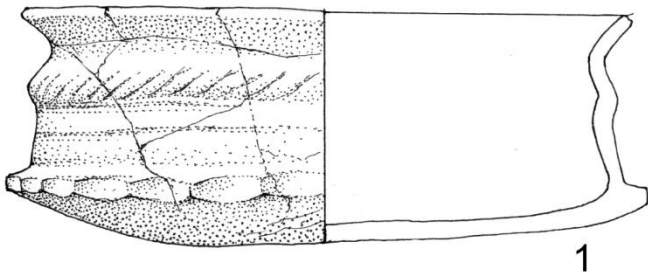

1

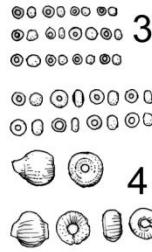

3



4

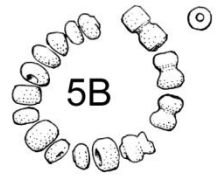

5A

5B

6

HROB 155

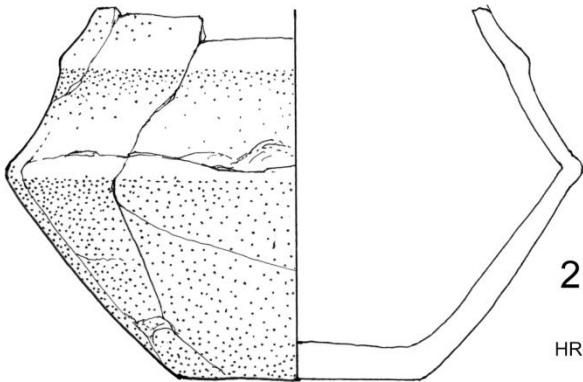

2

HROB 153

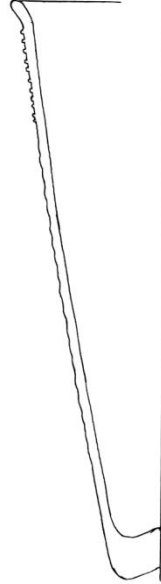

8

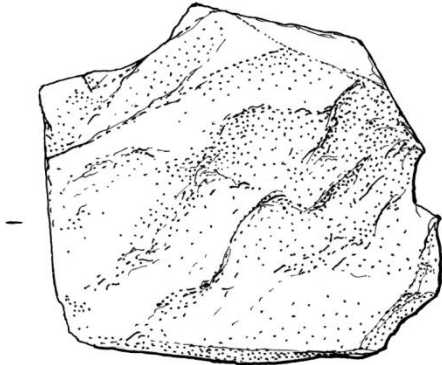
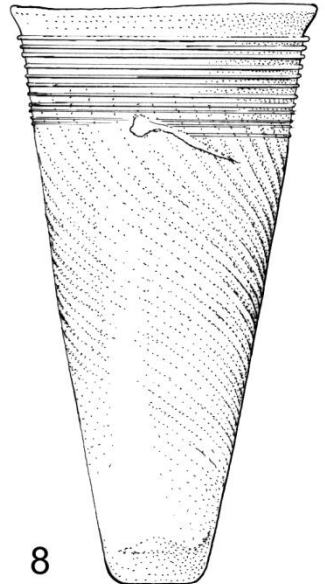

7

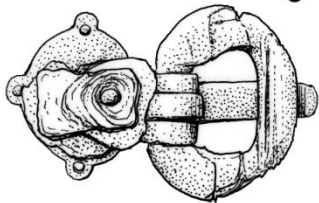
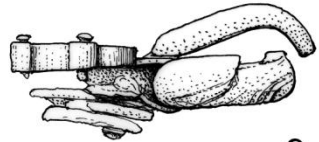
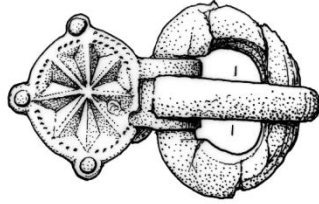
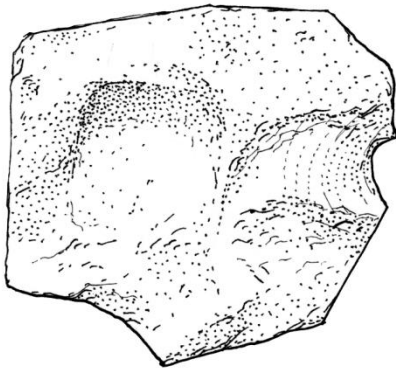

9

HROB 157

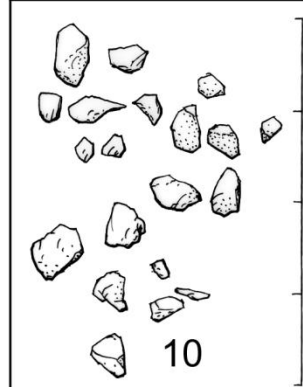

10

HROB 159

© 11

HROB 161

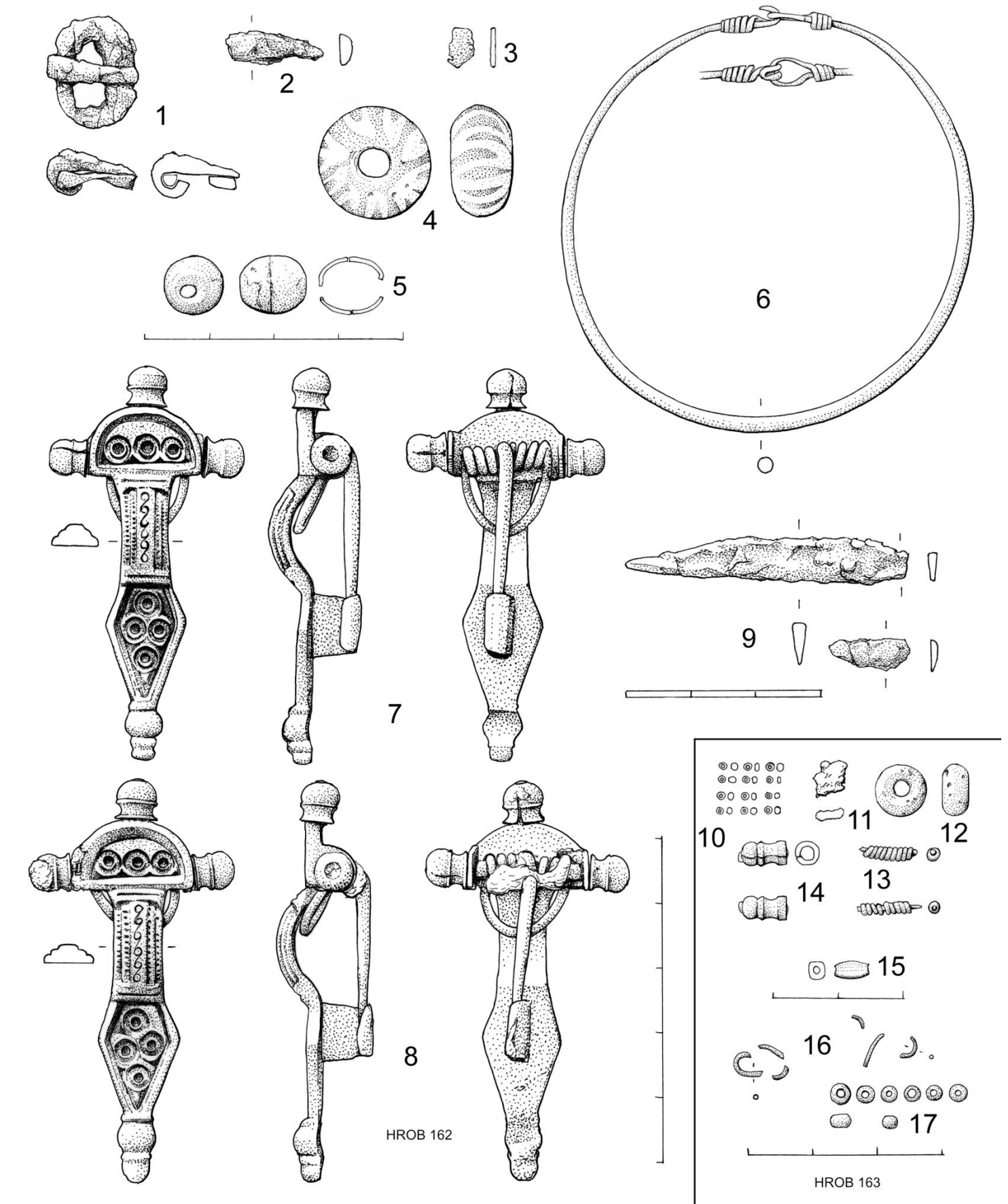

TABULKA 33

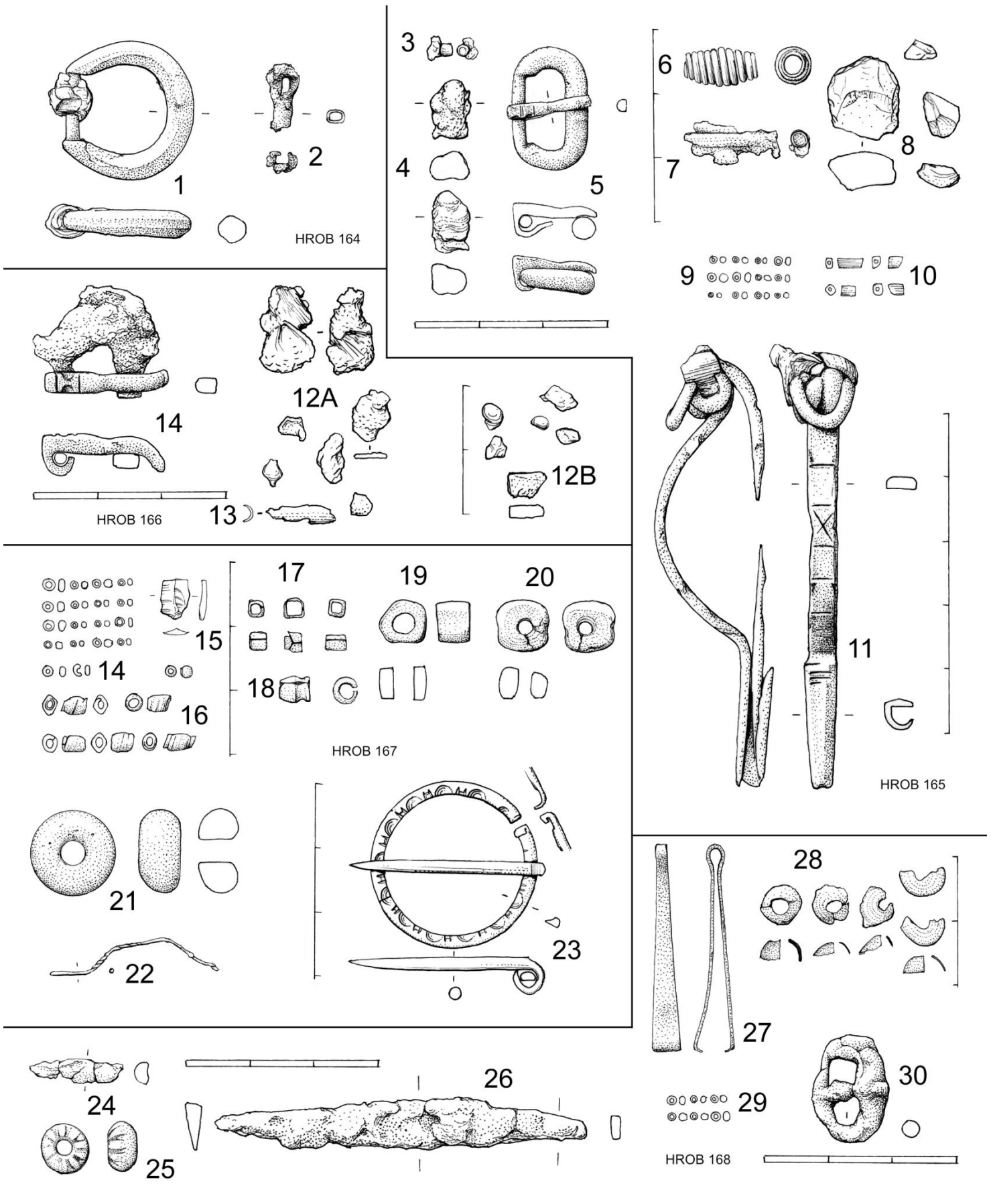

TABULKA 34

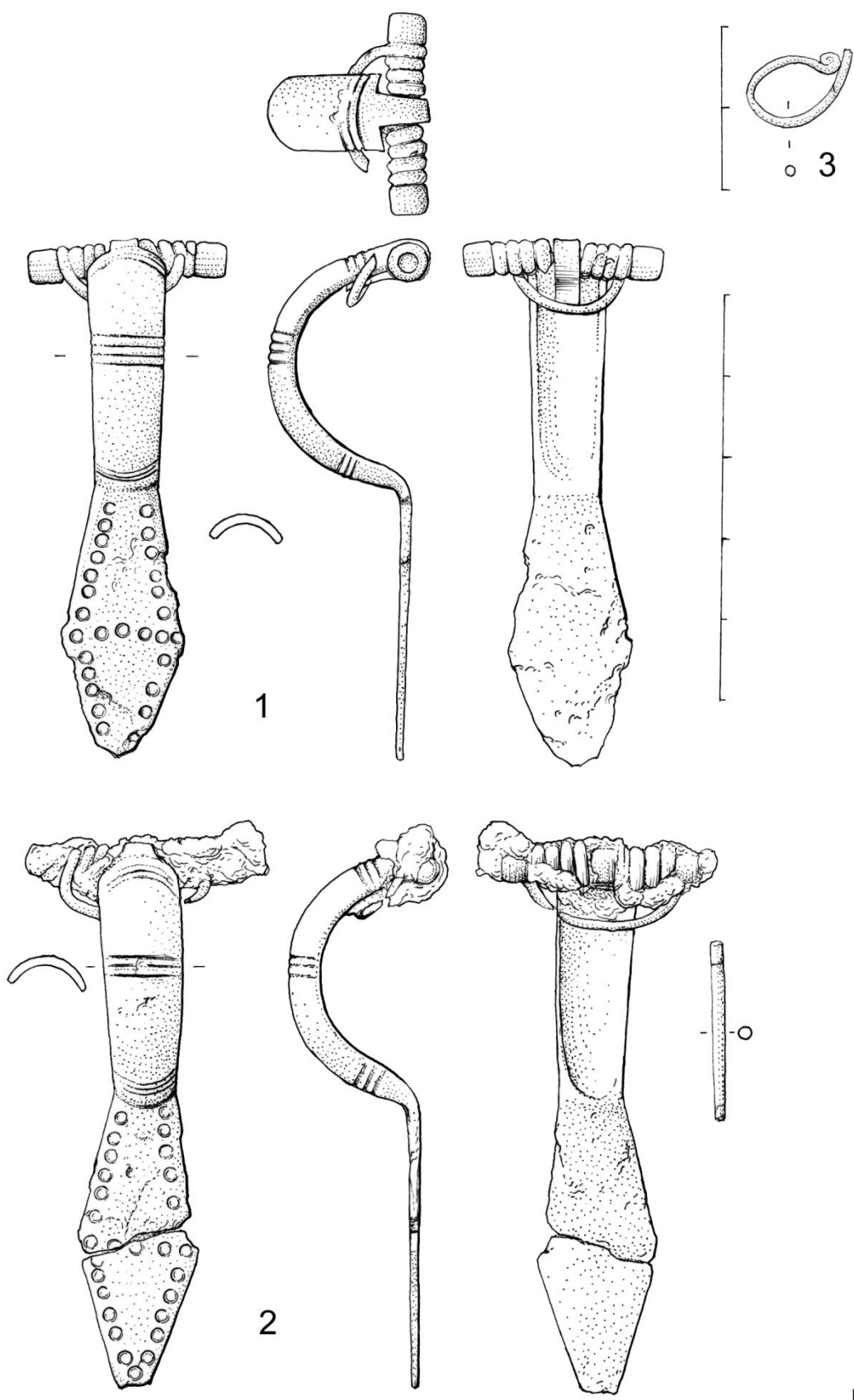

HROB 168

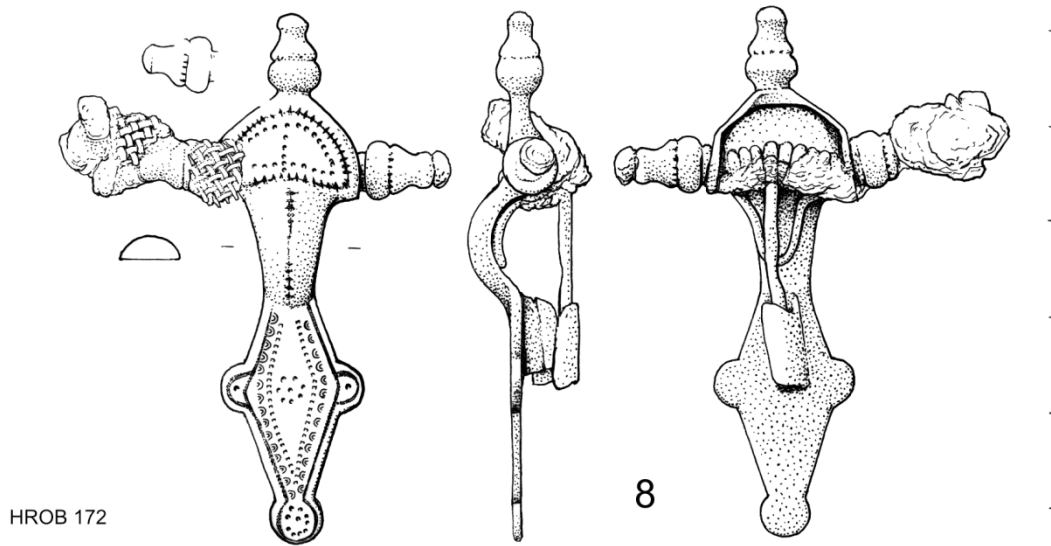
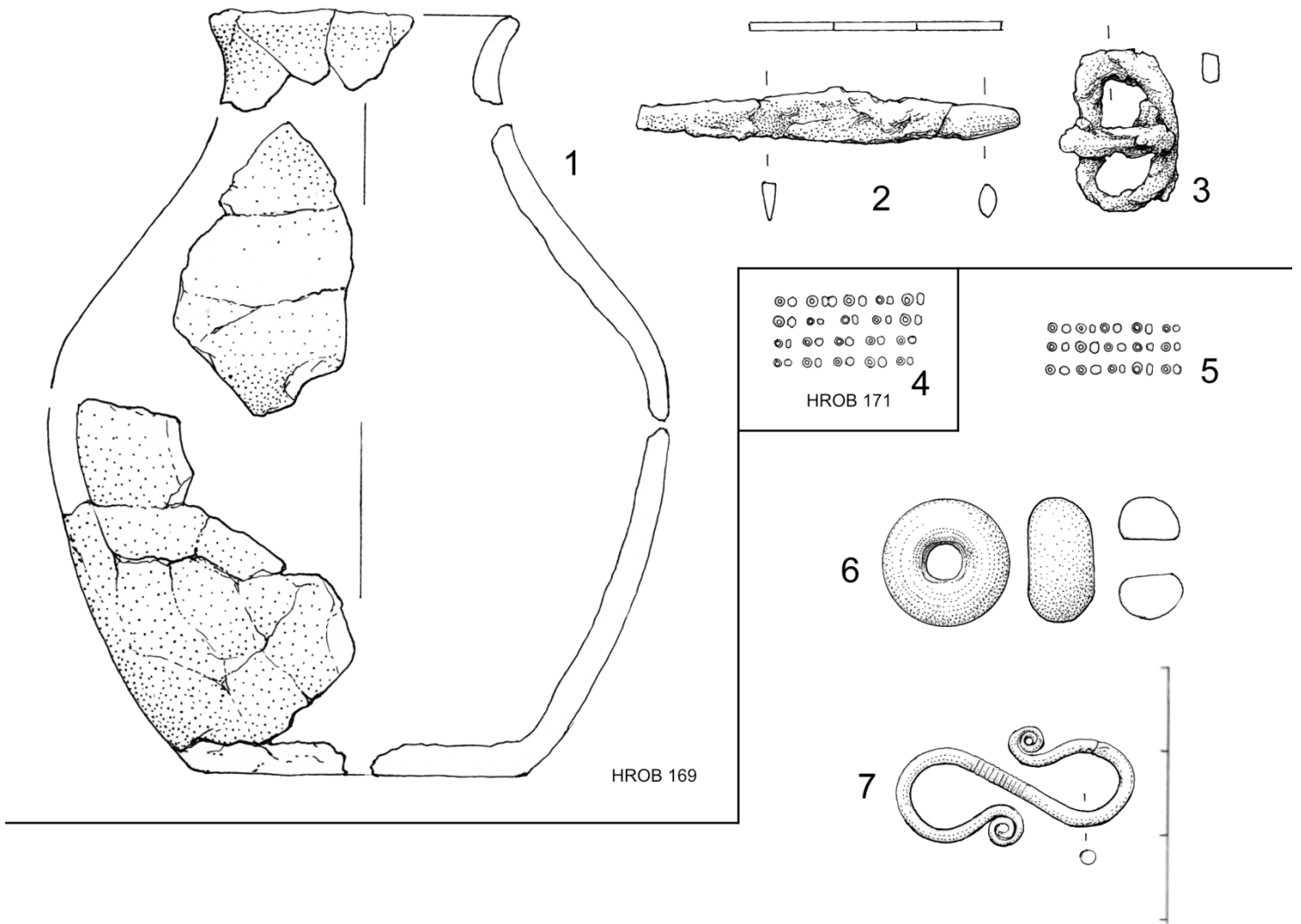

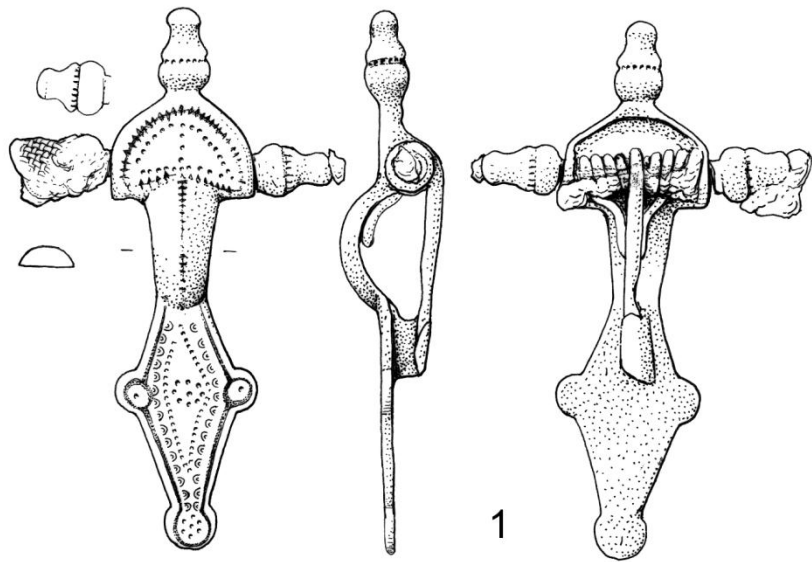

1

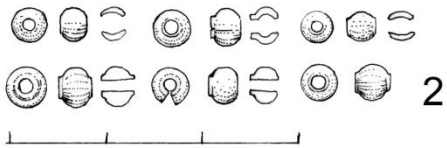

2

HROB 172

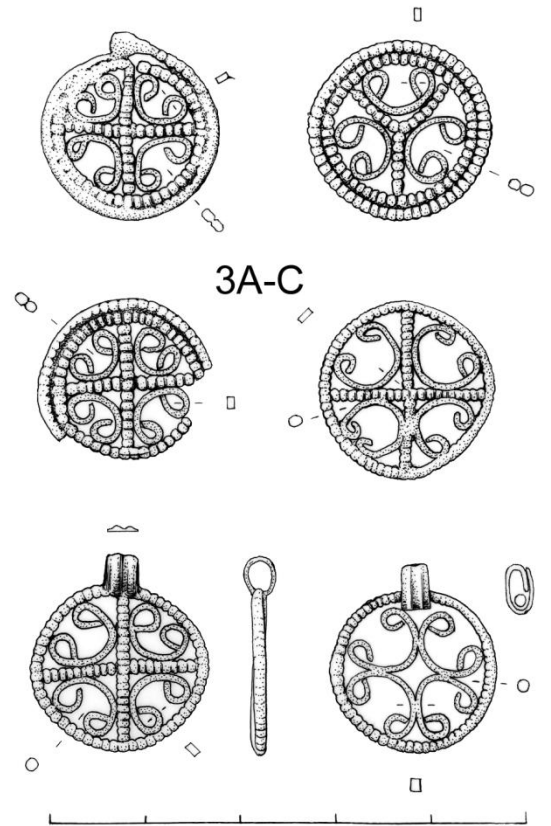

3A-C

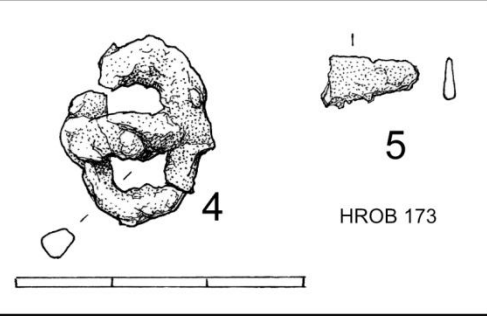

4

5

HROB 173

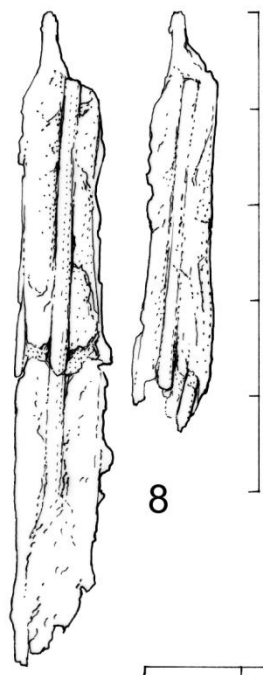

8

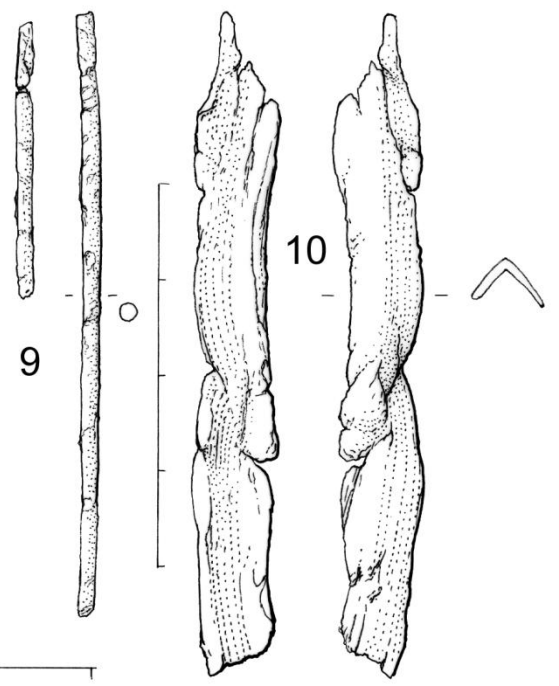

9

10

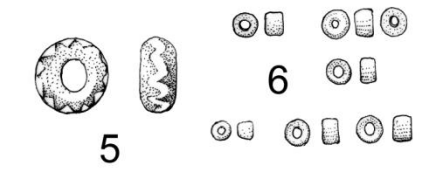

5

6

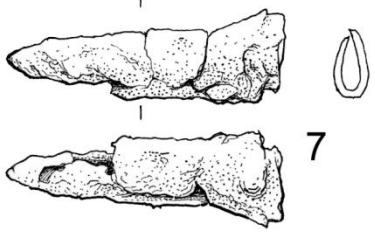

7



11

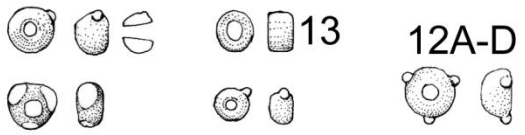

13

12A-D

HROB 174

⊙ □ ⊙ ⊙ ⊙ ⊙ ⊙ ⊙ ⊙ ⊙
⊙ ⊙ ⊙ ⊙ ⊙ ⊙ ⊙ ⊙ 4

HROB 175

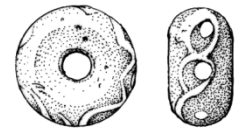
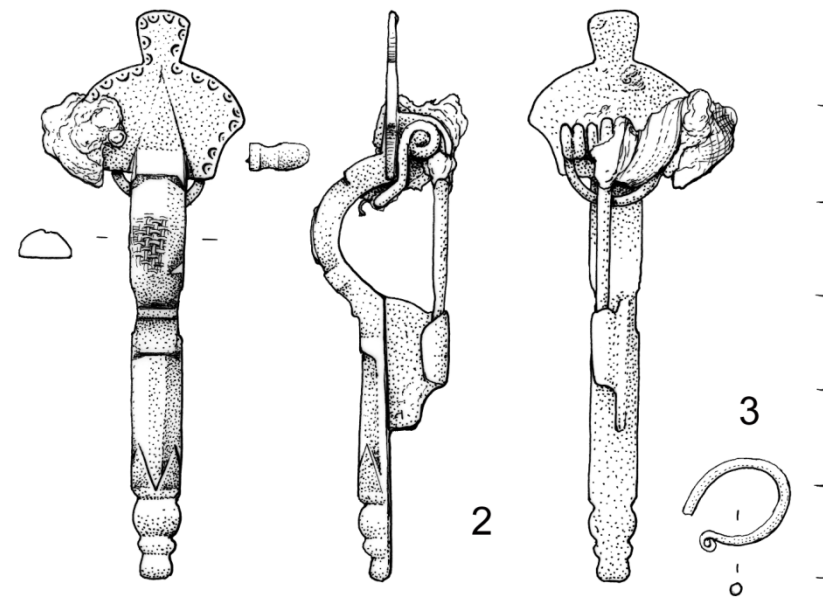
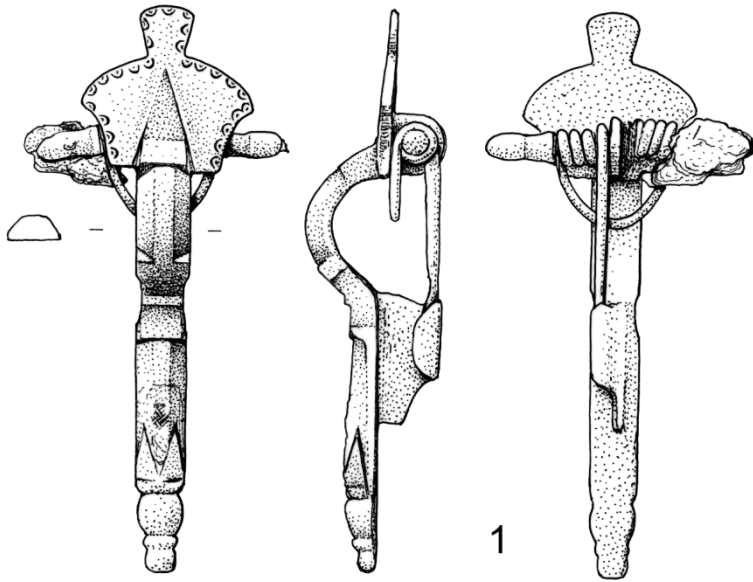

5



6



7

HROB 176

